

# GTS NX

GeoTechnical analysis System New eXperience

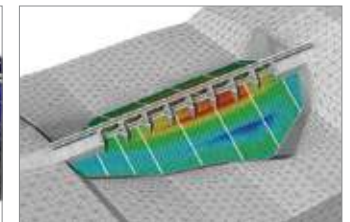
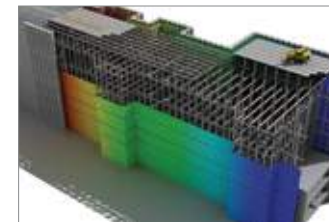

Integrated Solver Optimized for the next generation 64-bit platform

Finite Element Solutions for Geotechnical Engineering



# Why GTS NX

New subway complex, United States ▼

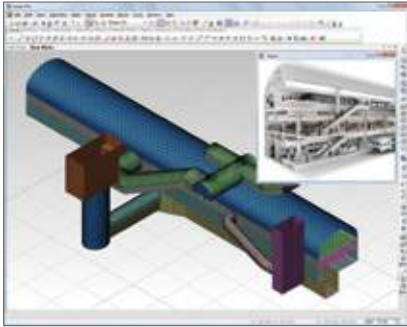

Odeon Tower, Monaco ▼

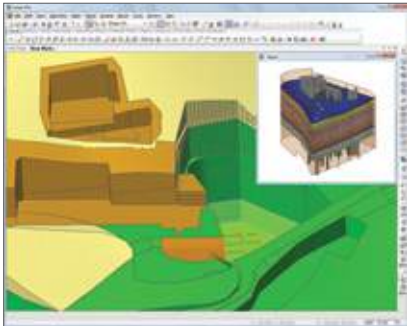

Sichuan Subway Station, China ▼

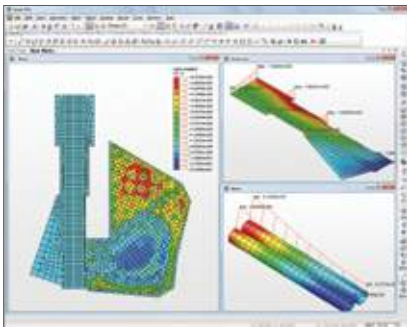

Shaft construction on the existing tunnel, United Kingdom ▼

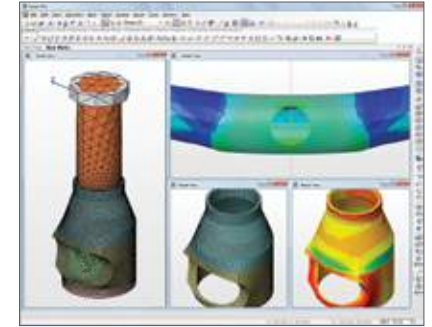

Dubai Tower, Qatar ▼

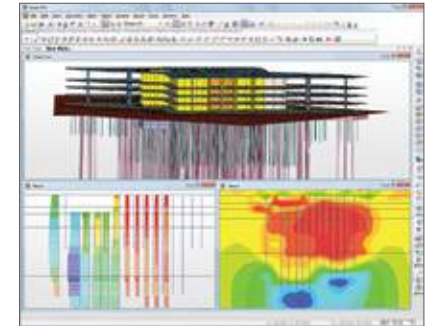

Buhang Dam, Korea ▼

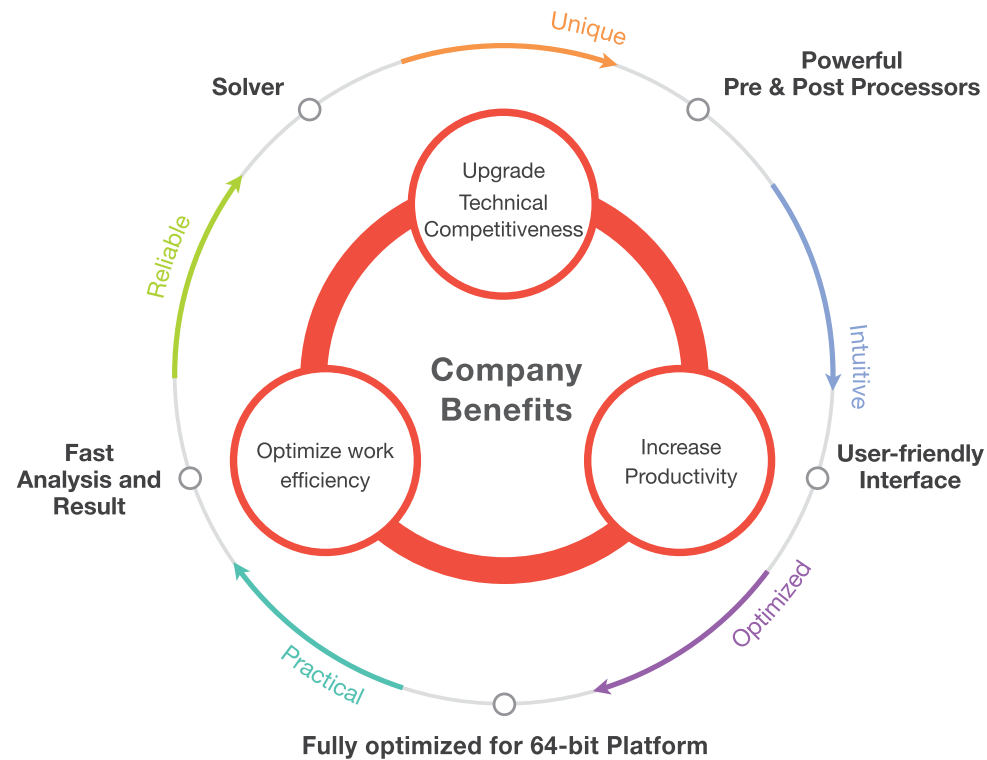
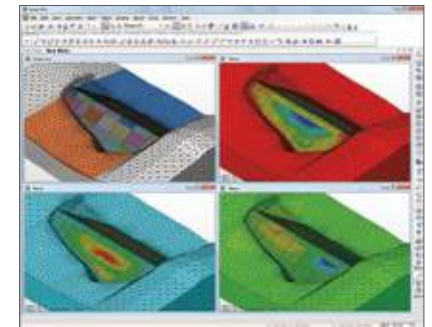

GTS NX is a next generation geotechnical analysis software that features the newest development in cutting-edge computer graphics and analysis technology. GTS NX fully supports the latest **64-bit OS Graphic user interface**. The intuitive interface will enable new users to easily integrate the software in their work process. The fast analysis speed, outstanding graphics, and output capabilities will provide users with a new and advanced level of geotechnical design.

# Analysis Method

## Geotechnical Analysis “New Experience”

GTS NX can simulate in-situ conditions by considering material nonlinearity as well as initial ground stresses. GTS NX supports all analysis types including static, dynamic, seepage, stress-seepage coupled, consolidation, construction stage and slope stability analysis.

In dynamic analysis, nonlinear time history analysis considering water level and self weight is supported. Any ground behavior that is related to ground water flow (seepage / stress / consolidation) can be simulated through fully coupled stress-seepage analysis. Through the fully integrated FE Solver, GTS NX provides highly reliable results for complex geotechnical analysis and design.

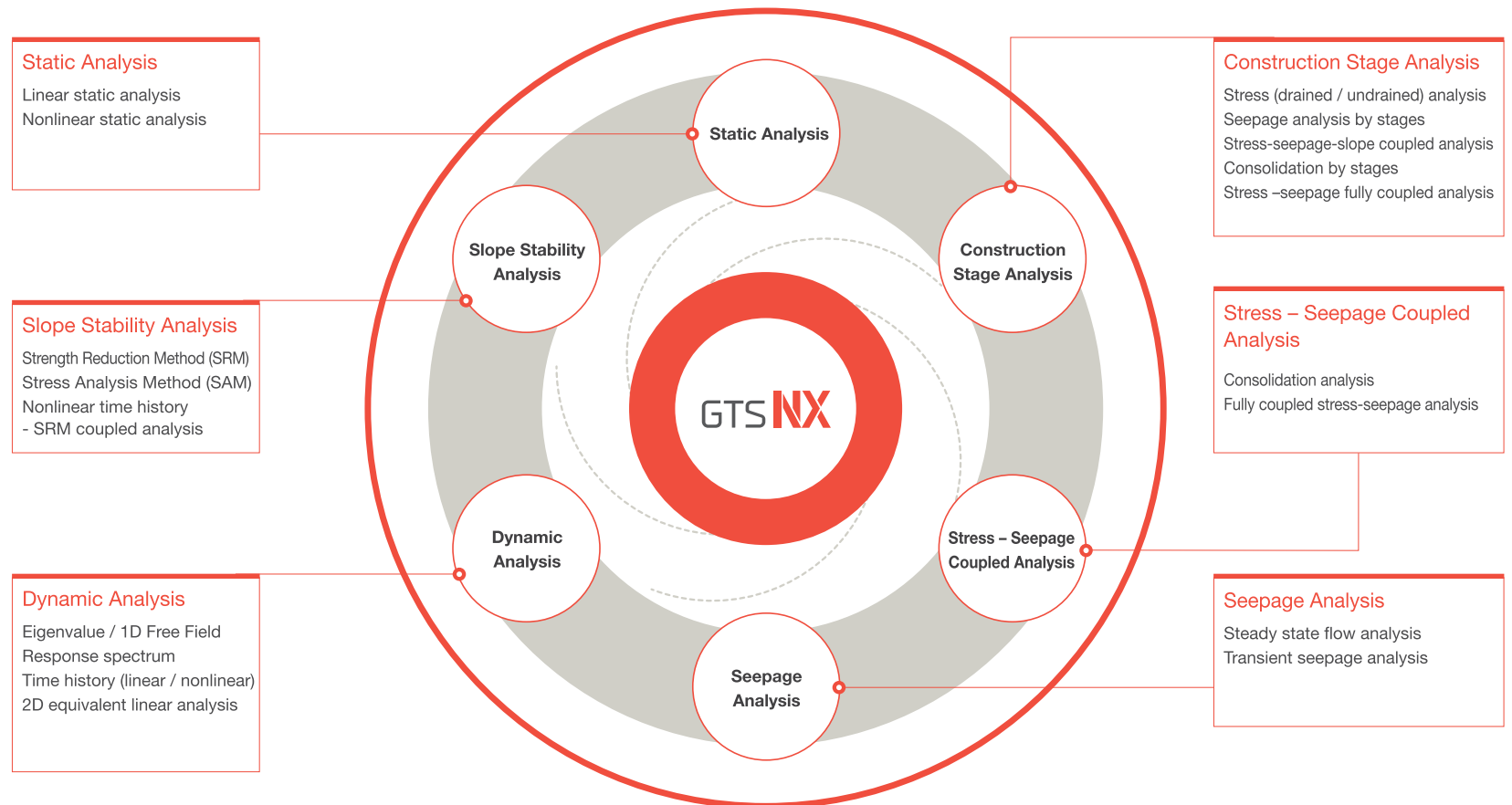

# Framework

## User-friendly Interface

GTS NX provides a user-friendly GUI (graphic user interface) through the use of a state-of-the-art graphics engine

### 1. Multi - Windows

Multi-Window GUI enables you to develop multiple model files simultaneously. You can view and modify the same model while the analysis is being run. Multiple analysis result items can be also viewed and compared simultaneously.

### 2. Ribbon menu for convenient tool organization

The menu has been designed to accommodate the modeling workflow. Similar functions and commands are intuitively grouped together for easier recognition. Command description, tips and diagrams explicitly guide you through the work process in the corresponding input windows.

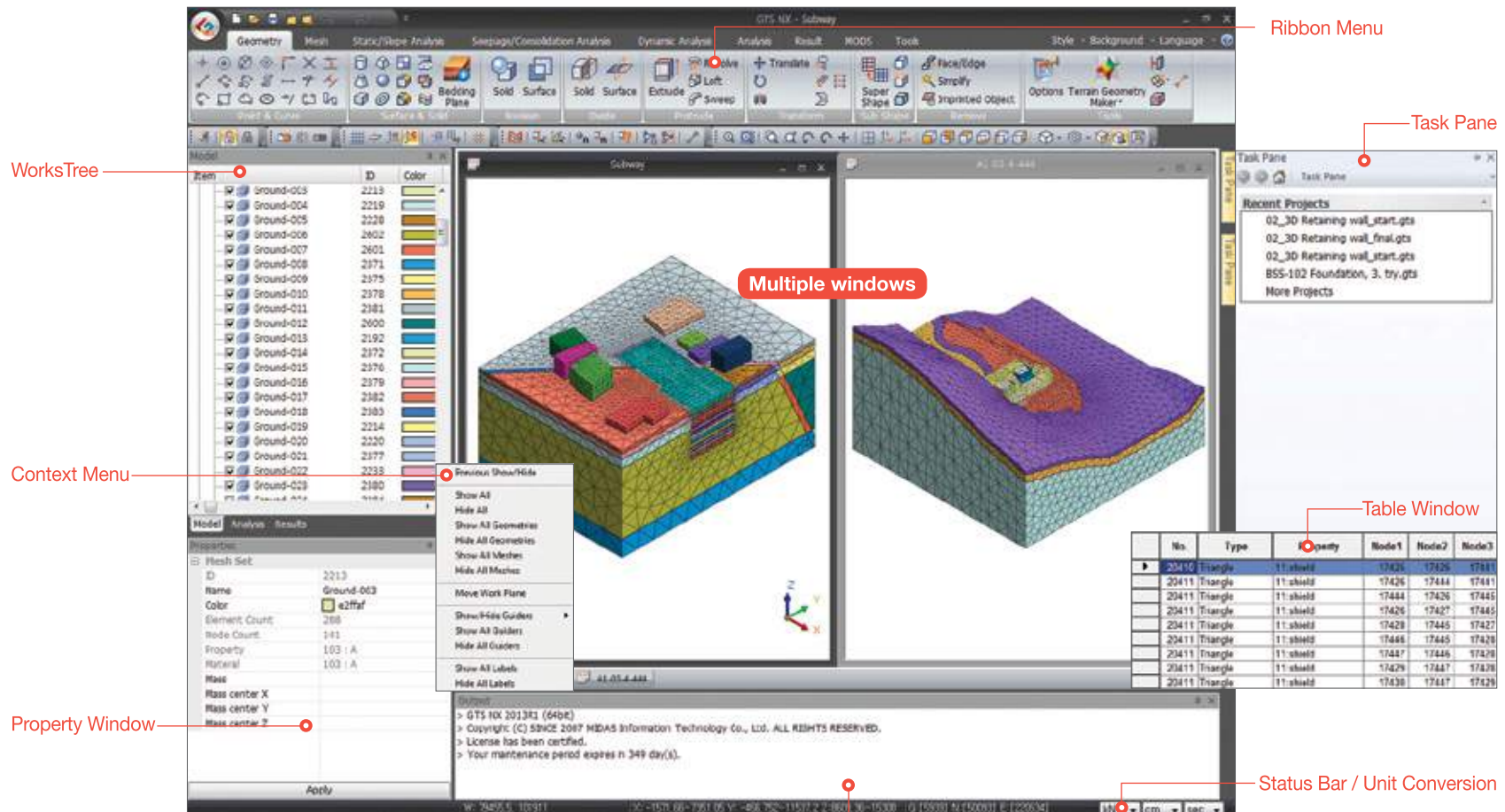

# Geometry Modeling

## CAD based modeling

Users can quickly become proficient with modeling in GTS NX – a tribute to CAD based 2D and 3D modeling commands.

### Point, Line

Line, arc, circle (oval), polyline, rectangle, extend curve, trim curve

### Face, Solid

Cylinder, cone, box, wedge, sphere, torus, plate, chamfer, offset

### Boolean Operation

Fuse, cut, common

### Divide, Protrude, Transform

Divide by surface, extrude, revolve, loft, sweep, mirror, scale, project

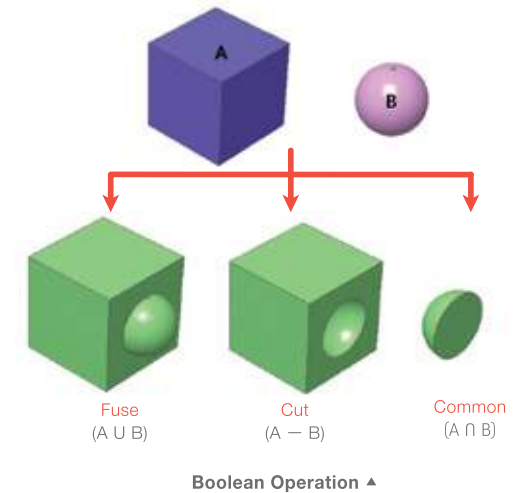
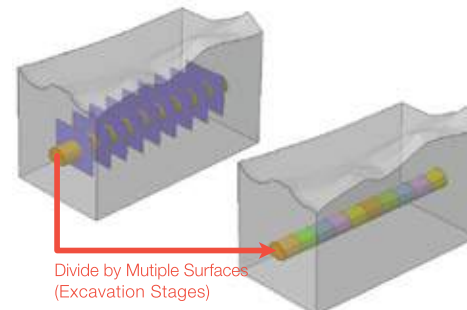
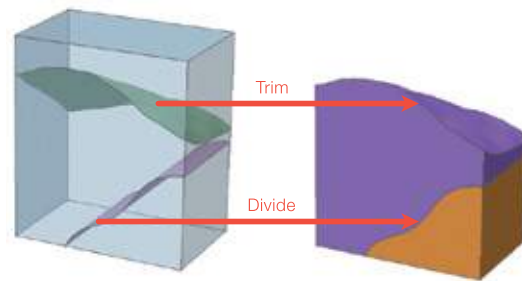
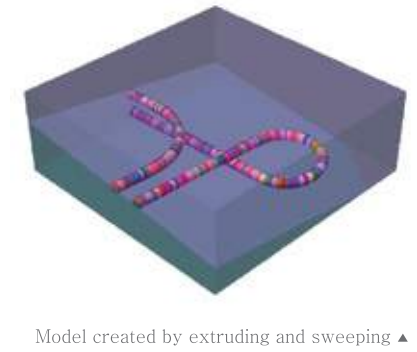
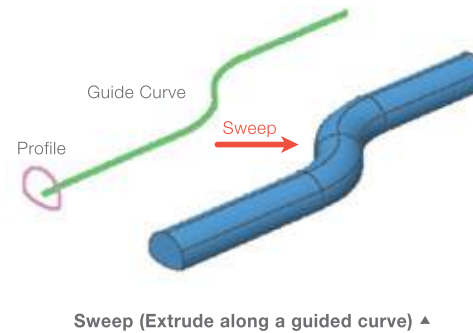
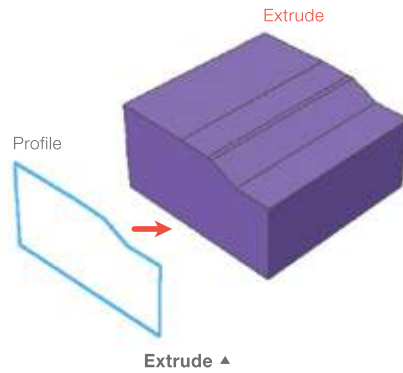

# Geometry Modeling

## Terrain Geometry Auto-Generation

Use digital maps and boring data to generate 3D models that more closely resemble in-situ conditions and will consequently yield more realistic results. Modeling 3D surface contours and soil strata can be either cumbersome or impractical in other software, but GTS NX only takes a few steps.

### TGM

Complex 3D ground surfaces can be created by selecting the target range in a digital topographic map.

### Bedding Plane Wizard

By inputting boring data on the plane surface, 3D strata can be automatically generated for the ground model.

### TGM (Terrain Geometry Maker)

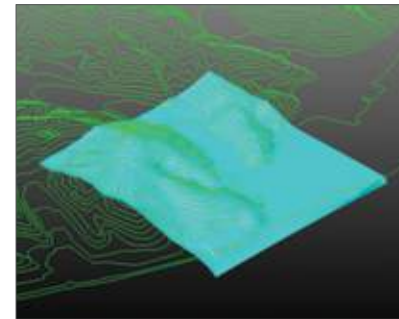

3D ground surface and contour lines



### 3D Stratum Wizard

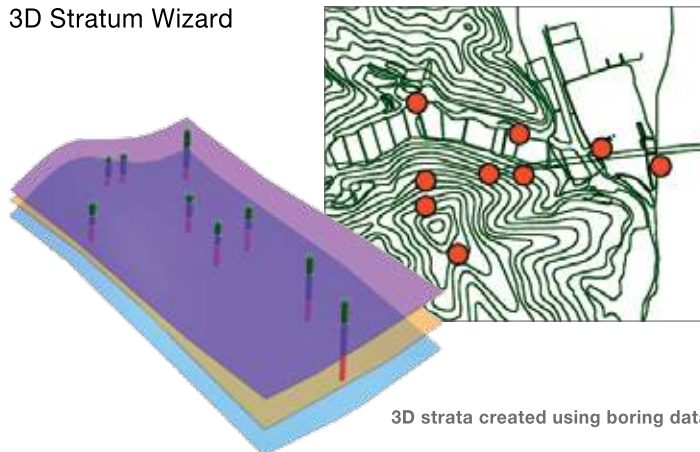

3D strata created using boring data

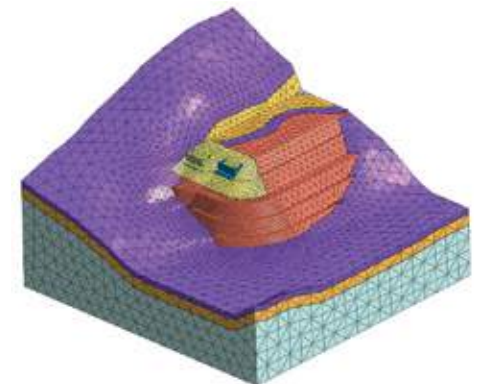

TGM and strata creation

# Geometry Modeling

## Geometry Modeling Automation

GTS NX automatically generates geometries such as shared faces and imprints. These functions ensure nodal connectivity between all adjacent mesh sets, thus ensuring reliable analysis of soil-structure and soil-soil interaction.

Modeling mistakes can also be automatically detected and corrected to prevent analysis from executing with failure warnings.

### Shared face auto-generation

Shared faces between adjacent solids can be generated automatically. This makes it easier to ensure nodal connectivity of adjacent mesh sets.

### Imprint auto-generation

The auto-imprint function allows lines and nodes to penetrate through 3D geometry [Solid].

### Modeling error detection and correction

Irregular faces, lines that may cause analysis errors can be automatically detected and deleted. Erroneously overlapped geometries such as small faces and edges will also be detected and deleted.

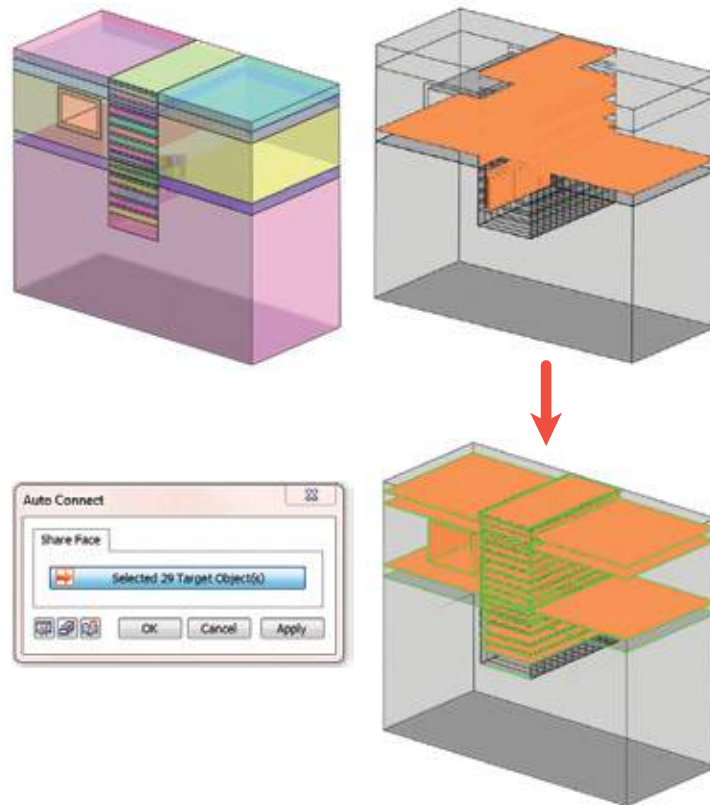

Shared face auto-generation ▲

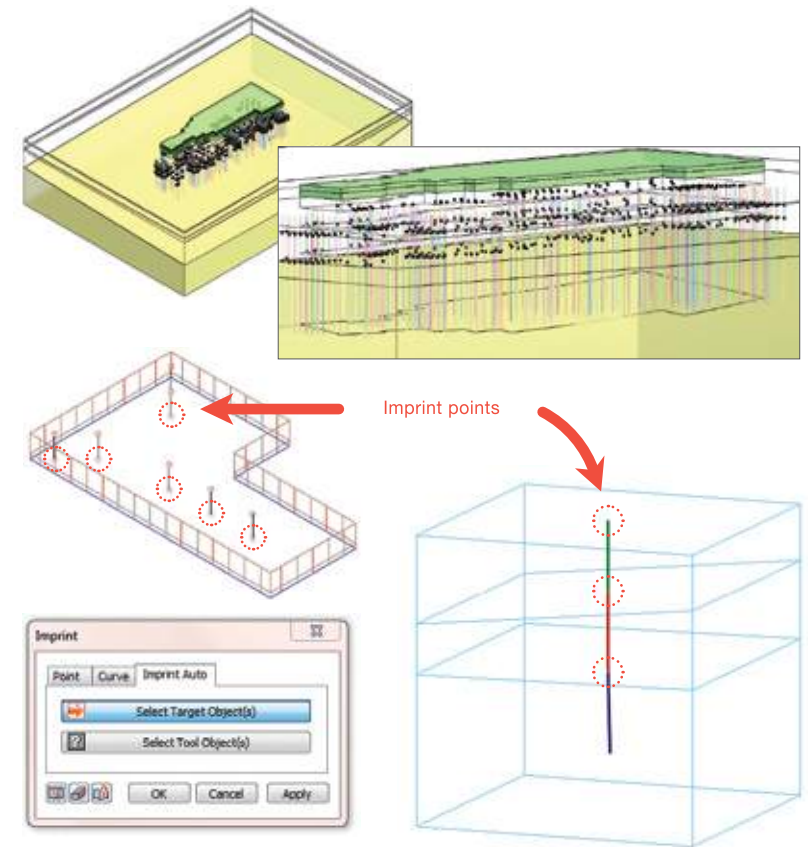

Auto-imprint ▲

# Geometry Modeling

## CAD Compatibility / Interface with other MIDAS Software

GTS NX imports model information from other MIDAS software (Gen, Civil & SoilWorks). The CAD interface transfers project data for expanded analysis requiring soil-structure interaction and detailed 3D investigation such as bridge pier and tall building foundations.

2D ground structure models can be also transferred to GTS NX for 3D analysis of ground engineering problems such as tunnel systems with connecting galleries.

### 2D / 3D CAD compatibility

\*.dwg, \*.dxf, parasolid  
CAD Interface option  
(CATIA V4, 5, Pro/E, Solidworks, STEP, IGES, ACIS, Inventor, Unigraphics)

### SoilWorks Interface

Any cross section

### Neutral Format File

\*.FPN

### Gen, Civil Interface

Geometry and element information  
Structure cross section  
Frame → solid conversion

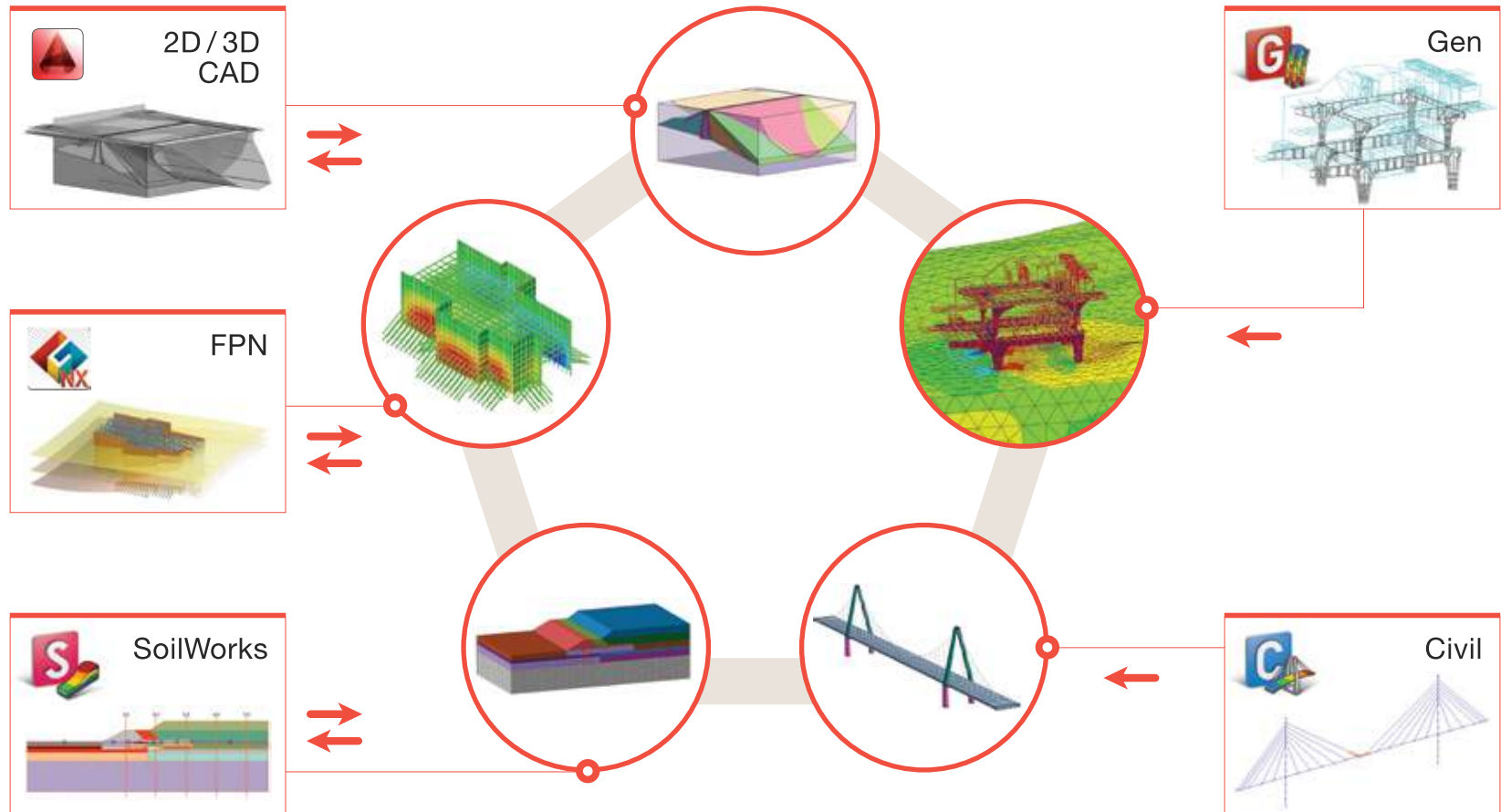



# Mesh Generation

## Optimized mesh generation of various element types

User friendly modeling functions generate complex geometries and mesh sets of various types with ease. Such capabilities enable engineers to quickly generate high quality mesh even with limited or no experience in finite element modeling.

### Surface Auto-Mesher

Loop, Grid, Delaunay (triangle, quadrangle)

### Solid Auto-Mesher

Tetrahedral, Hexahedral, Hybrid (hexahedral centered)

### 2D → 3D Element Auto-Generation

### Protrude Mesh (2D → 3D)

Extrude, Revolve, Sweep, Project, Offset, Fill

### Extract Mesh (3D → 2D)

### Interface, pile, and structural element generation

### Element generation considers interior edges and points

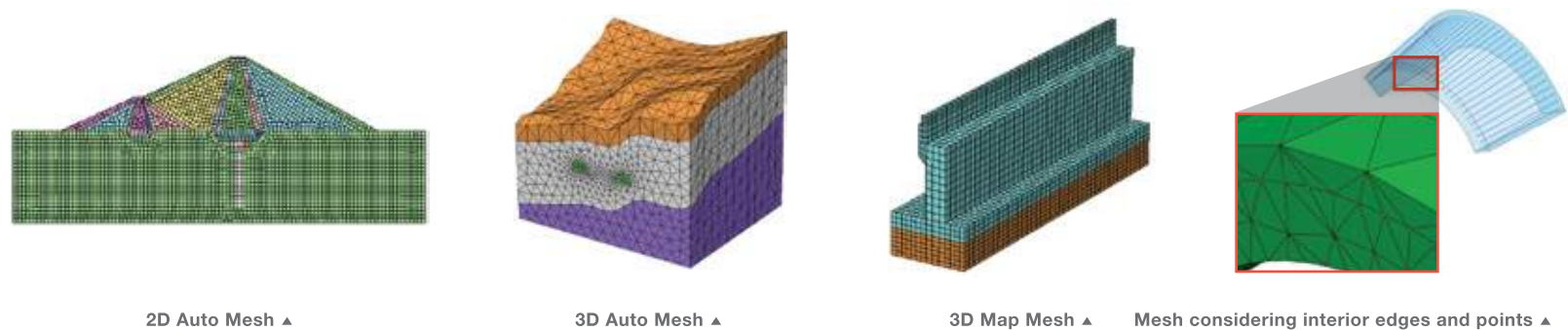

2D Auto Mesh ▲

3D Auto Mesh ▲

3D Map Mesh ▲

Mesh considering interior edges and points ▲

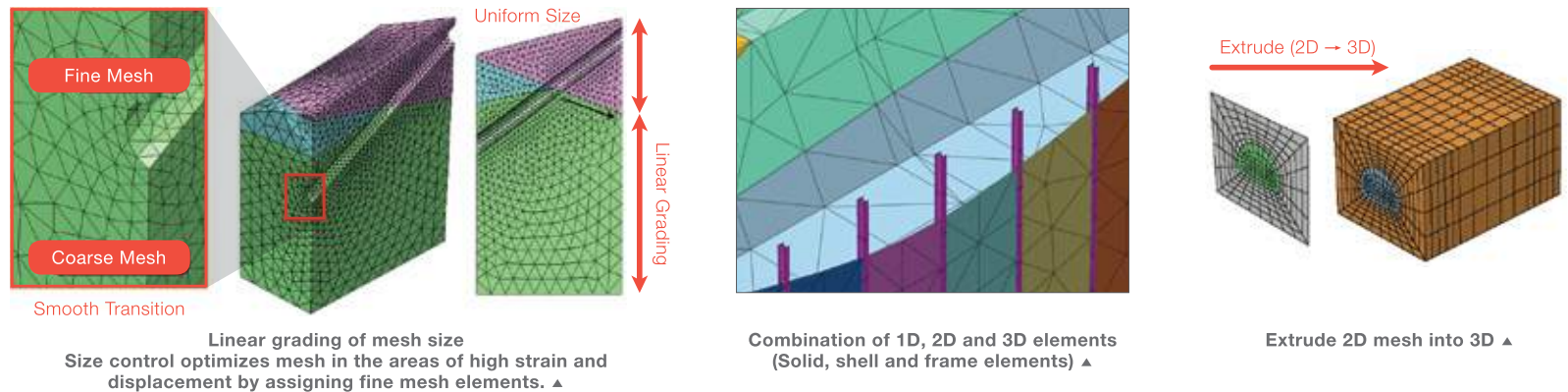

Smooth Transition

Linear grading of mesh size  
Size control optimizes mesh in the areas of high strain and displacement by assigning fine mesh elements. ▲

Combination of 1D, 2D and 3D elements  
(Solid, shell and frame elements) ▲

Extrude 2D mesh into 3D ▲

# Mesh Generation

## Quality Assurance & Checking Controls

Mesh quality can be automatically checked and managed. This allows the generation of high quality mesh with minimum effort even for complex ground structural models resulting in optimal analysis time and producing reliable and comprehensive results.

### Hybrid Mesher

To provide more reliable analysis results, GTS NX can automatically generate hexahedral centered hybrid mesh. Hexahedral elements are the most stable for stress and displacement results.

### Bonded Contacts Auto-generation

Adjacent elements without shared nodes can be detected and contacts can be applied automatically

### Mesh Check

- Non-manifold edge
- Free face
- Clamped element
- Overlapped element

### Mesh Quality Check

Aspect ratio, skew angle, twist angle, taper, Jacobian ratio, element length (Maximum, Minimum), poor mesh sets definition

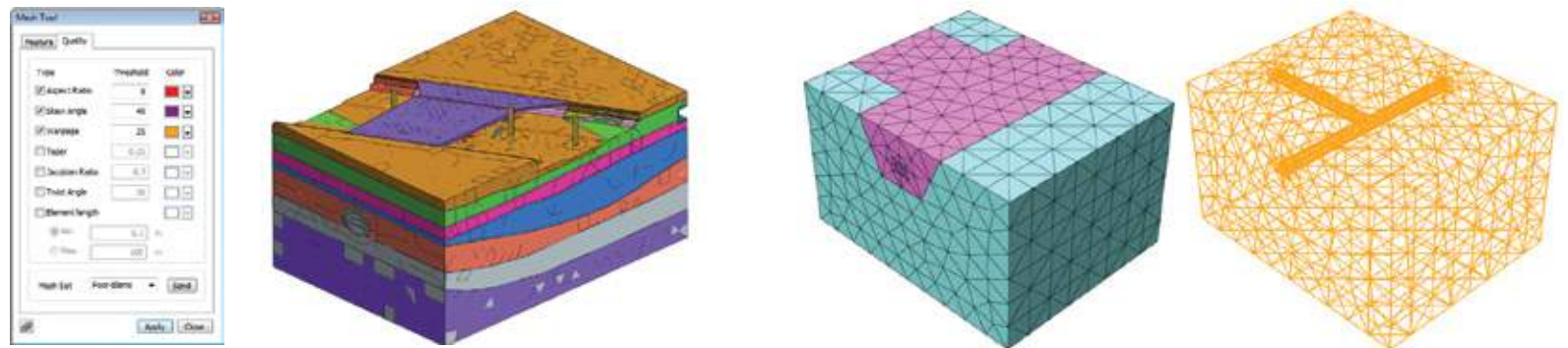
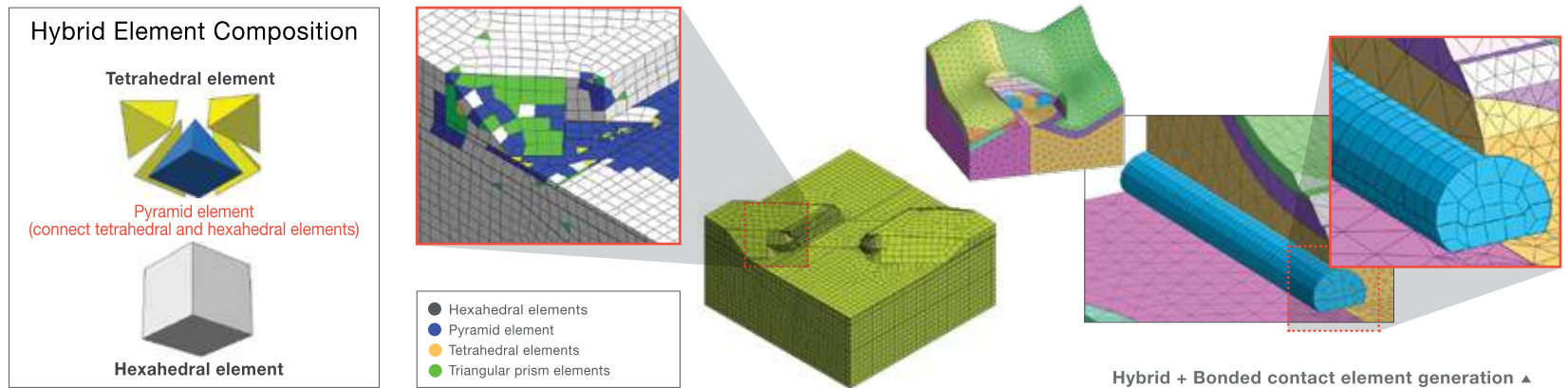

# Element Library

## Element library

The GTS NX element library includes various elements for structural and ground modeling. These elements are conveniently classified based on application purposes. Ground, structures, various links, springs and interfaces can be selected and modeled from the extensive element library.

### Continuum Elements for ground

- Solid Element
- Plane Strain Element
- Axisymmetric Element

### Structural Elements

- Truss Element/ Embedded Truss
- Beam Element/ Embedded Beam
- 2D Orthotropic/ Axisymmetric
- Plane Stress Element
- Shell Element

### Applicable Elements

- Interface Element
- Shell Interface Element
- Pile / Pile Tip Bearing Element
- Geo-grid Element (1D / 2D)
- Gauging Shell Element
- Point Spring / Face Spring Element
- Matrix Spring Element
- Elastic Link Element
- Rigid Link Element
- Interpolation Element
- Contact Element (General/ Welded)
- Free Field

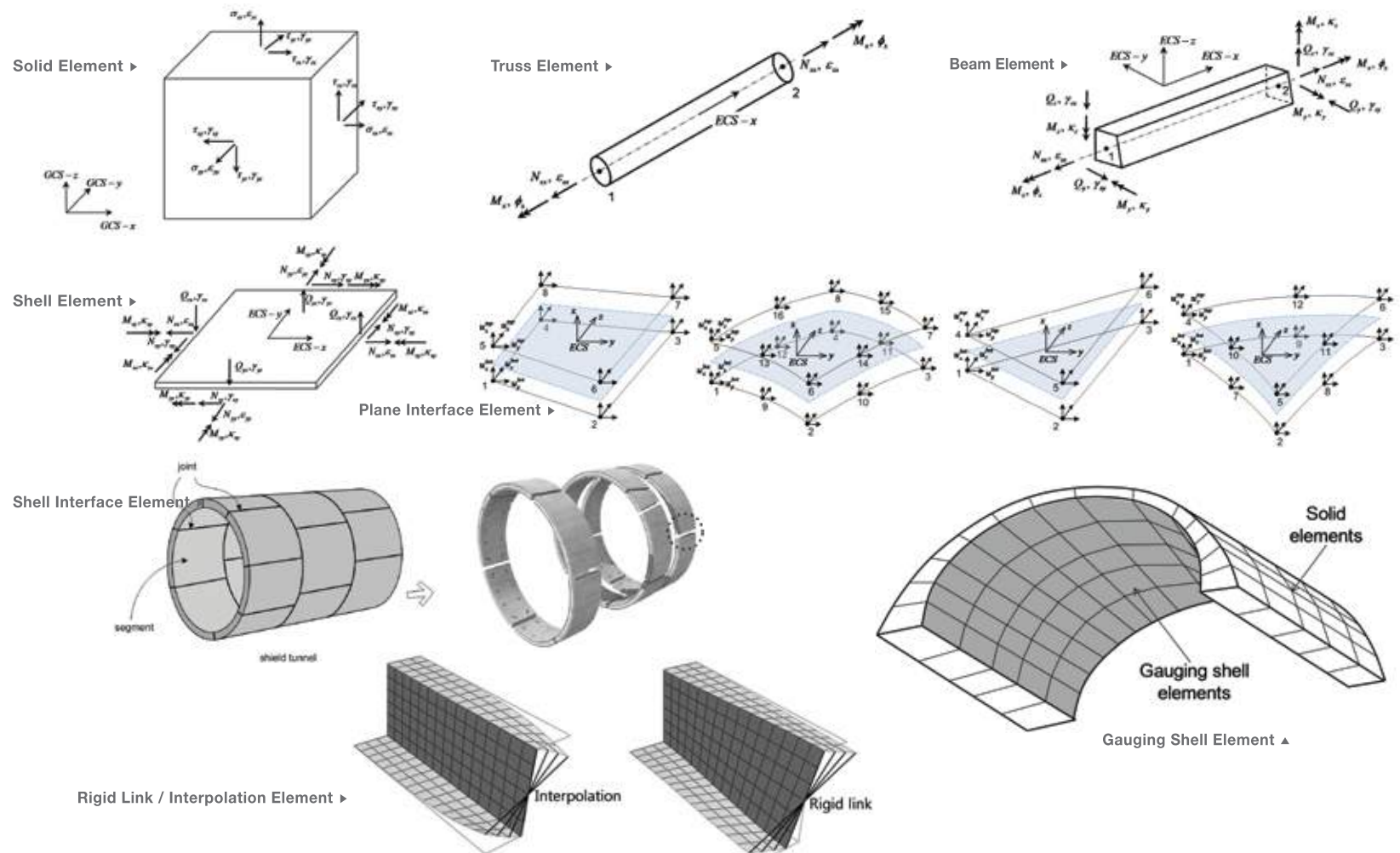

# Material Models & Structural Properties

## Comprehensive database of material models to simulate the behavior of various ground types

GTS NX provides various linear / nonlinear material models to simulate ground behavior under different loading and water level conditions.

Material models are generally classified into elastic, plastic, drained, undrained, and seepage categories. Material / equivalent linearity and nonlinearity of elements can be simulated through internal functions.

**Elastic Materials**

**Plastic Materials**

**Undrained Materials**

**Functions**

### Elastic Materials

- Linear Elastic Isotropic
- Linear Elastic
- Transversely Isotropic
- Interface Elastic
- Nonlinear Elastic (1D)
- Jardine
- D-Min
- Hyperbolic (Duncan-Chang)

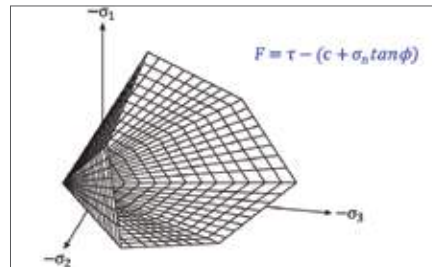

### Plastic Materials

- von Mises (Nonlinear)
- Tresca
- Mohr-Coulomb
- Drucker-Prager
- Strain-Softening
- Modified Cam Clay
- Jointed Rock
- Modified Mohr Coulomb
- Hoek Brown
- Inverse Rankine
- Coulomb Friction (Interface)
- Janssen
- Soft Soil / Soft Soil Creep
- Sekiguchi-Ohta (Viscid/Inviscid)
- Hardening Soil (small strain stiffness)
- Modified UBSCAND (Liquefaction)
- S Clay 1 Model

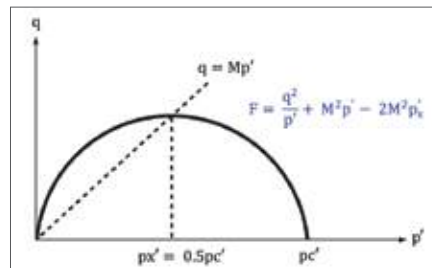
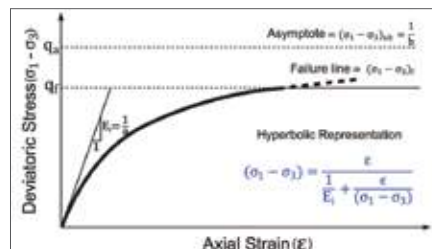

- Generalised Hoek Brown
- Hysterisis Models
- User Defined

### Undrained Materials

- Effective Stiffness / Effective Strength
- Effective Stiffness / Undrained Strength
- Undrained Stiffness / Undrained Strength

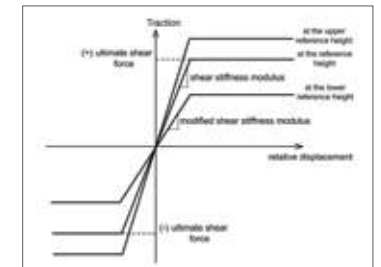

Pile bearing ▲

### Functions

- General non-spatial functions (pile / pile tip bearing nonlinear function)
- Nonlinear elastic functions (truss / point spring / elastic link)
- Unsaturated property functions (Gardner, Frontal, Van Genuchten)
- Strain compatibility functions (2D equivalent linear)
- Concrete Creep and Shrinkage functions automatically as per global codes

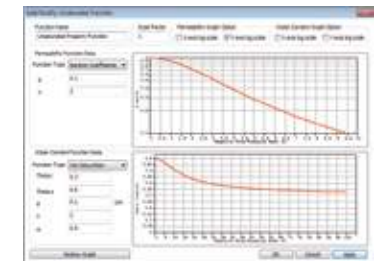

Unsaturated property (Individual) ▲



Strain compatibility ▲

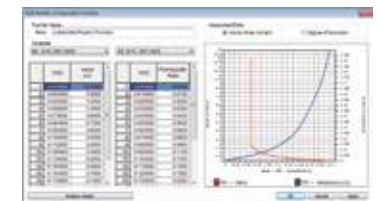

Unsaturated property (Relation) ▲

# Load conditions Generation and Application

## Load assignment reflecting field conditions

GTS NX can simulate various in-situ loading conditions. The dynamic function database includes a variety of code-based response spectra and time history functions. Customized functions for vibration, blast and seismic loading can be also generated.

### Structural Loads

- Force (concentrated load / pressure)
- Gravity
- Prescribed displacement
- Temperature load

### Static / Dynamic Loads

### Loads in Construction Stages

- Load distribution factor

### Nonlinearity of Load

In geometric nonlinear analysis, the direction of loads can change with the deformation of the structure. (Follower Load)

### Loads from Results

Nodal forces, moments, translational/rotational displacements can be created to loads for another analysis case

## Static Loads

- Self weight
- Concentrated load
- Moment load
- Prescribed displacement
- Pressure load
- Water pressure (auto-consideration option)
- Beam linear load
- Beam element load
- Temperature load
- Prestress load
- Initial equilibrium load
- Combined load

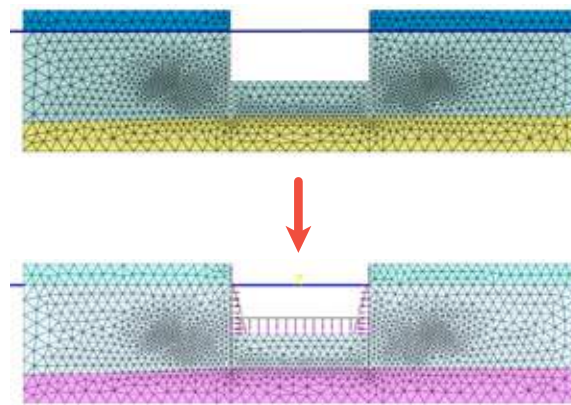

Water pressure automatic application during underwater excavation ▲

## Dynamic Loads

- Response spectrum
- Ground acceleration
- Time history static load
- Dynamic nodal load
- Dynamic surface load
- Load – mass conversion
- Railway dynamic load table

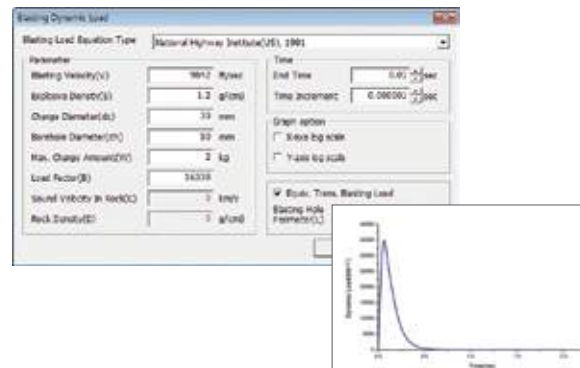

Dynamic blast load automatic generation ▲

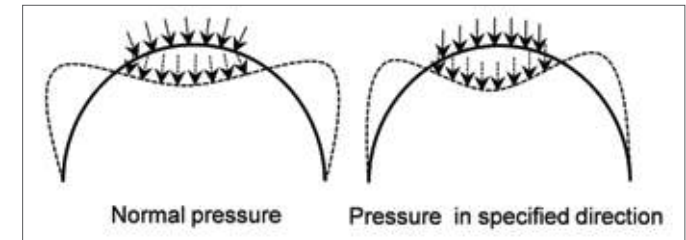

Follower Load- nonlinear load ▲

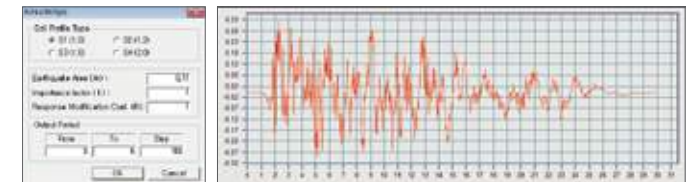

Seismic data automatic generation ▲

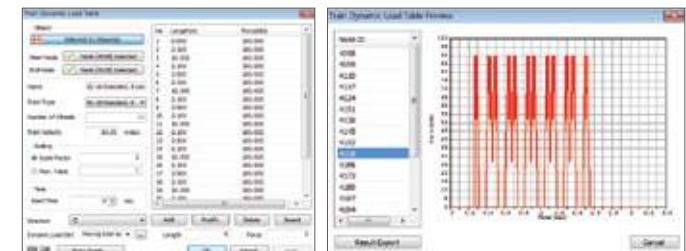

Train moving load automatic generation ▲

# Boundary Conditions

## Different boundary conditions can be generated to simulate in-situ conditions

GTS NX provides various boundary conditions for all analysis types. Essential boundary conditions for analysis can be defined automatically. By defining the water level surface, the pore water pressure can be considered in stress analysis. Time dependent water levels can be defined to simulate rapid draw down as well as a gradual rise in water level due to rainfall.

The Change Property function can simulate a change in material properties over time. This function is useful for simulating the hardening of concrete as well as excavation projects in which soil layers are replaced by structural elements. Boundary conditions for 2D equivalent linear analysis and linear / nonlinear dynamic analysis can be generated automatically as well.

### Constraint

Automatic definition of constraint for ground  
Fixed / pinned / rotation

### Slope Stability Analysis

Slip circular surface  
Slip polygonal surface

### Seepage / Consolidation Analysis

Nodal head / Nodal flux / Surface flux /  
Review / Drained condition / Non-consolidation

### Dynamic Analysis

Elastic boundary / Viscous boundary  
Damper consideration in free ground /  
Transmitting Boundary

### Boundary Conditions from Results

Import seepage boundary conditions for  
further analysis

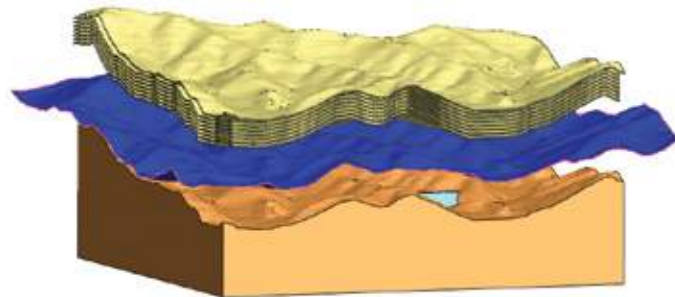

3D water level generation ▲

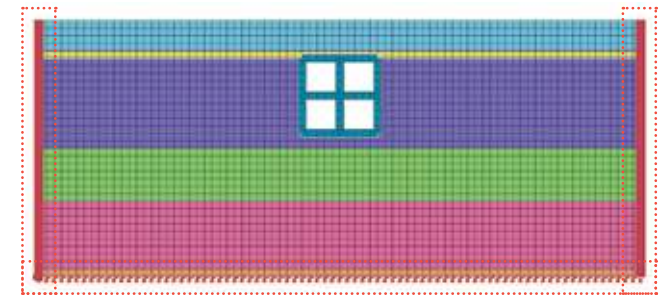

Dynamic analysis (soil structure interaction) boundary generation ▲

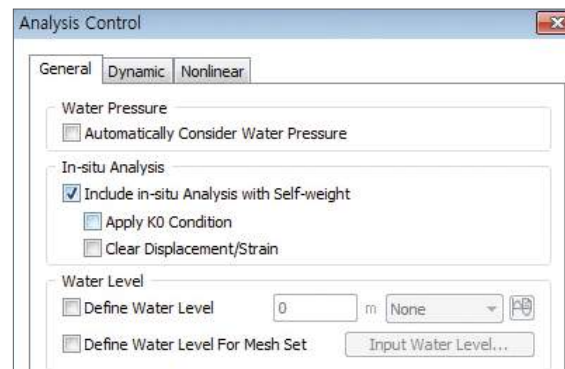

In-situ analysis with Self weight considering k0 ▲

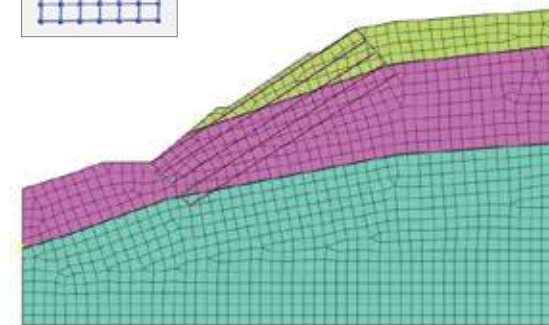
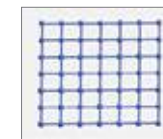

Slip circular surface boundary for stress analysis (SAM) ▲



# Results Output and report

## Excellent result displays supported by a new and powerful graphics engine

Through its advanced graphic processing engine, GTS NX provides a variety of output methods for users to visualize and extract their analysis results. The extensive output options present results in an elegant and comprehensible form.

Contour – Continuous / Fringe

Vector, Diagram

Deformed / Undeformed

Multi-Step Iso Surface

Iso Value Surface

Flow Net

Failure Surface of Slope

Time History Graph

Real-Time Animation

3D → 2D Result Wizard

Extract results on any 2D cross section from 3D results without extra calculation

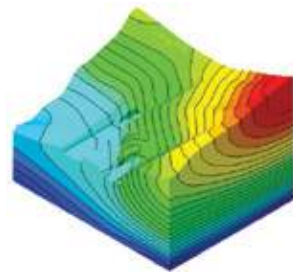

Various contour and edge types ▲

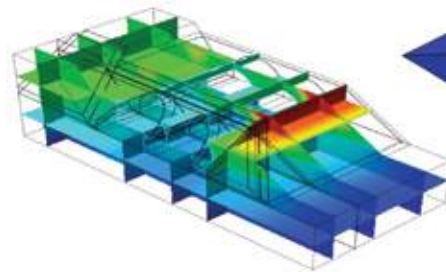

Clipping plane output ▲

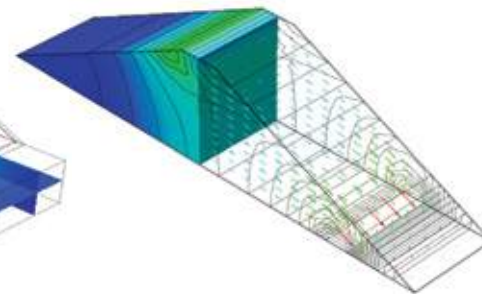

Hybrid plot (Combination of vector and contour plot on clipping plane) ▲

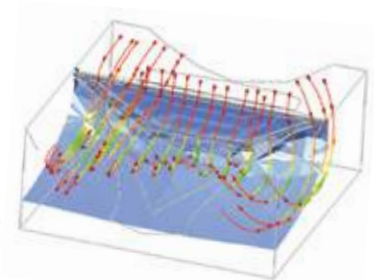

Real-time animation output for 3D flow ▲

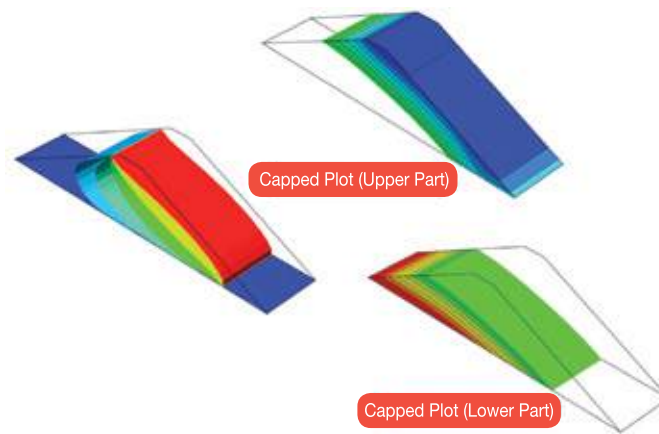

Iso – surface output ▲

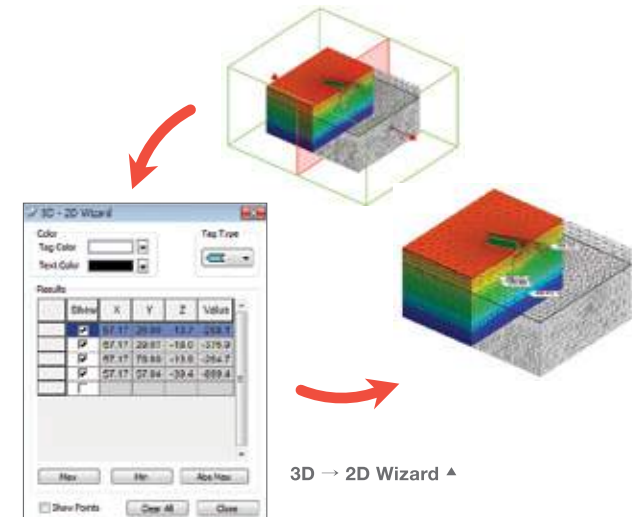

3D → 2D Wizard ▲

# Results output and Report

## Results output and report for practical design

The results output functions allow users to combine different results and selectively extract only the pertinent results. The 3D PDF report generator exports 3D model and analysis results directly into a PDF file.

The report generation creates aesthetic and comprehensive reports in a fraction of the time that it would take through manually copying and pasting spreadsheets and images.

Cutting Diagram on any line and plane

Extract Result / Probe Result

3D PDF Output

3D model / analysis results can be checked and operated in a PDF file

Graph / Table / Result Image Automatic save

Text File Results Output

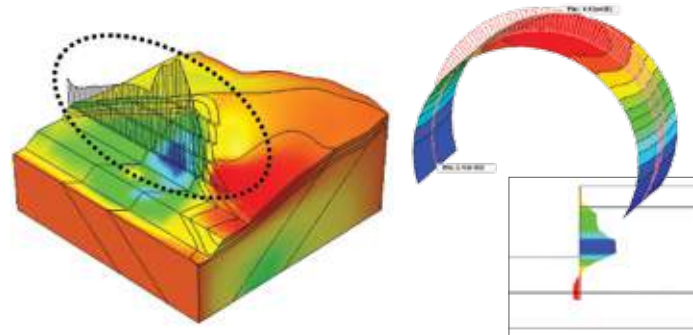

Result distribution / change diagram on any line ▲

Member / cutting-plane diagram ▲

Displacement / Velocity / acceleration – decibel conversion  
Decibel Reference Levels (ISO R 1683)

	Quantity	Definition	Ref. level
Amplitude Ratio	Vibratory Acc. Level	$L_a = 20 \log_{10} (a/a_0)$ dB	$a_0 = 10^{-6} \text{ m/s}^2$
	Vibratory Vel. Level	$L_v = 20 \log_{10} (v/v_0)$ dB	$v_0 = 10^{-9} \text{ m/s}$
	Vibratory Dis. Level	$L_d = 20 \log_{10} (d/d_0)$ dB	$d_0 = 10^{-12} \text{ m}$

Convert to Decibel ▲

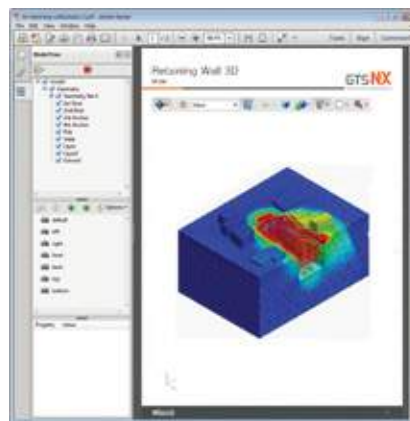

3D PDF Report ▲

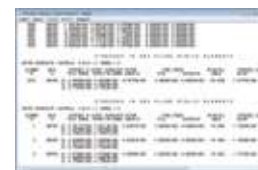

Text Output ▲



Result image automatic save ▲

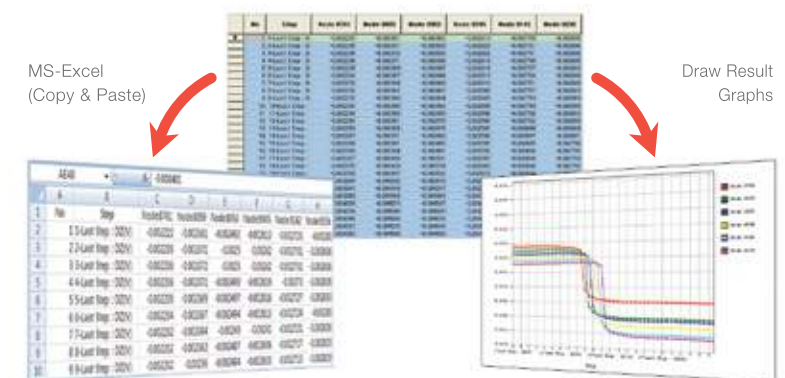

Result value table (copy and paste to MS-EXCEL) and graph ▲



# Application Areas

## | Tunnel |

### Road Tunnel

Portal, Cross passage, Refuge area (Emergency zones), Ventilation shaft, Electrical room, Fault fractured zone, Adjacent structures

### Railway / Subway Tunnel

Fitting (T, Y-type), Shield TBM, Machine Room, TRcM / CAM, Station

### Steel Pipe Roof

Steel Strut, Full face / Bench cut, Ring cut, CD cut, Open cut, 2 Arch, 3 Arch

## Total Solutions for Geotechnical Analysis

GTS NX is proven numerical modeling software used by many international geotechnical firms. Selected practical applications of the software are shown below.

The Tunnel Wizard can model tunnels having standard pattern and define excavation methods such as full face cut, bench cut and direction (one, both). For each case, load relaxation can be considered by applying load distribution factor (LDF). Modelling shrinkage or simulate a volume loss around a lining of TBM tunnel through **Contraction** function. Subsequently, **Tunnel Lining Design** can be executed accurately and efficiently.

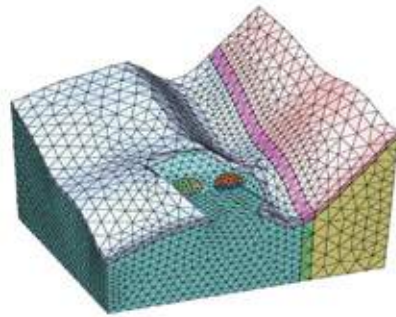

Portal With Fault fractured zone ▲

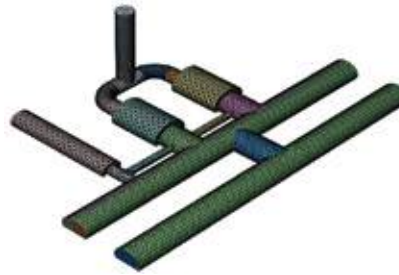

Ventilation shaft (Vertical / Horizontal) ▲

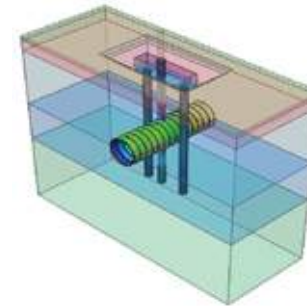

Shield TBM ▲



Steel pipe reinforced grouting (Pipe Roof) ▲

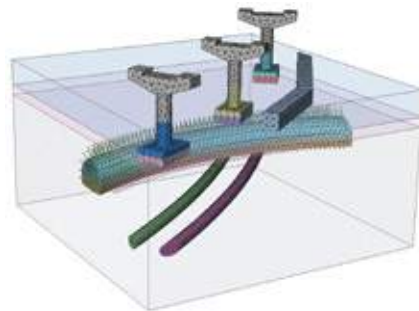

Adjacent structures ▲

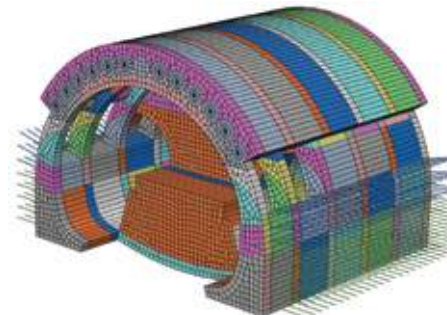

TRcM / CAM (Subway tunnel) ▲

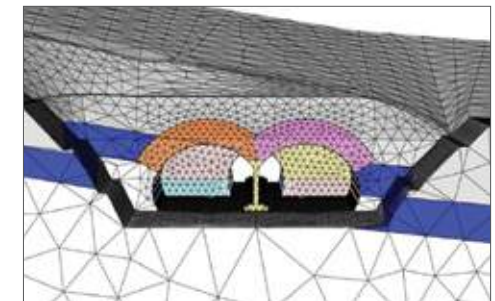

2-Arch Tunnel (NATM Method) ▲

# Application Areas

## | Slope Stability |

### Total Solutions for Geotechnical Analysis

GTS NX not only analyzes 2D / 3D slope stability according to Strength Reduction Method (SRM) but also calculates the slope safety factor according to Limit Equilibrium Method using potential sliding surfaces. Analysis result in each calculation step can be obtained, so the progressive failure behavior of the slope can be analyzed.

Stress analysis and seepage analysis considering cutting stages can be coupled to investigate slope stability in short / long term. Especially by coupling with nonlinear time history analysis results, earthquake resistance of a slope can be assessed.

#### Strength Reduction Method Analysis (SRM)

- 2D / 3D SRM Analysis
- SRM Analysis by construction stages
- SRM considering rainfall
- Nonlinear Dynamic Analysis + SRM Analysis

#### Stress Analysis Method (SAM)

- Potential Sliding surface + SRM Analysis
- Consideration of rainfall / staged analysis

#### Evaluation of slope reinforcement

- Nail, Rock bolt, stabilizing piles, retaining wall
- Evaluation of reinforcement stability in slopes reinforced by structural members

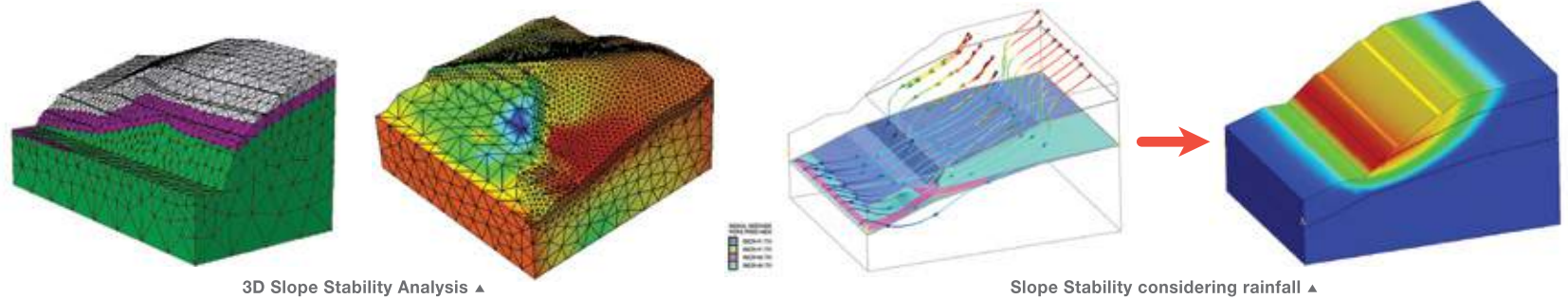

3D Slope Stability Analysis ▲

Slope Stability considering rainfall ▲

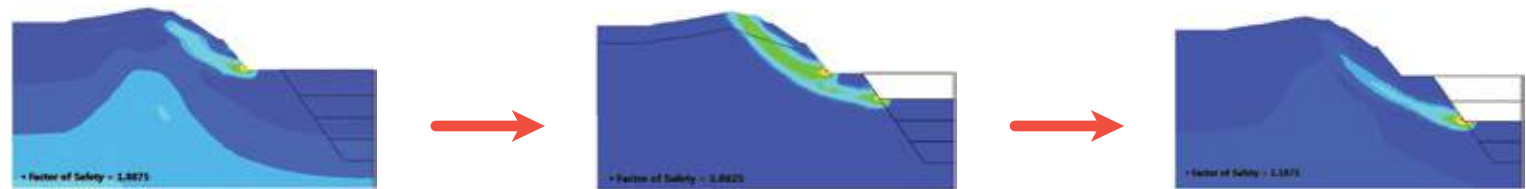

In-situ State ▲

1<sup>st</sup> Excavation ▲

2<sup>nd</sup> Excavation ▲

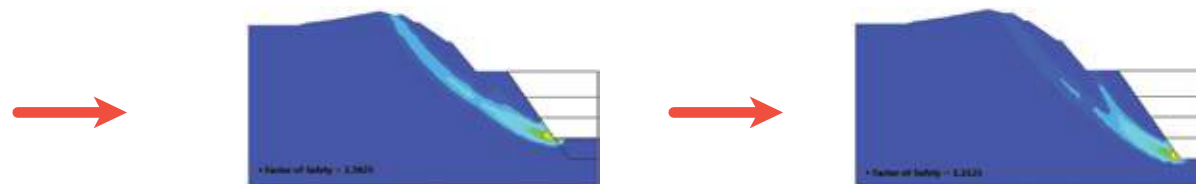

3<sup>rd</sup> Excavation ▲

Final Stage ▲

# Application Areas

| Foundations |

| Excavation / Retaining wall |

## Total Solutions for Geotechnical Analysis

### Foundations

GTS NX analyzes abutment stability subjected to lateral pressure and differential settlements. Bearing capacities of piles can be parametrically verified for different materials and construction methods.

**Shallow foundation:** Direct foundation, Mechanic (Vibration) foundation

**Deep foundation (Pier / Abutment):** Pile (Steel Pipe, PHC, Drilled Shaft (RCD), Driven Pile), Well foundation, Caisson, Raft foundation

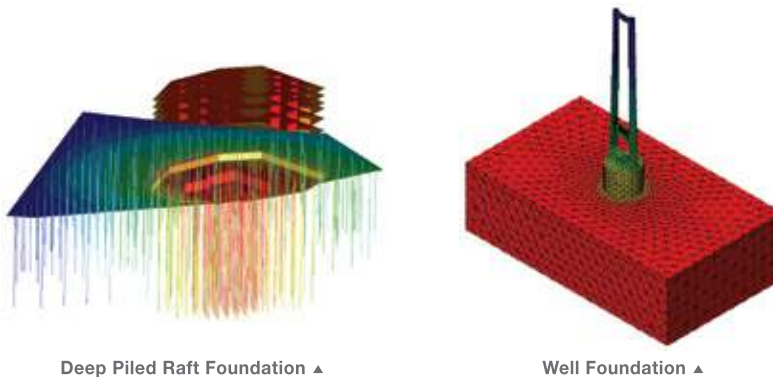
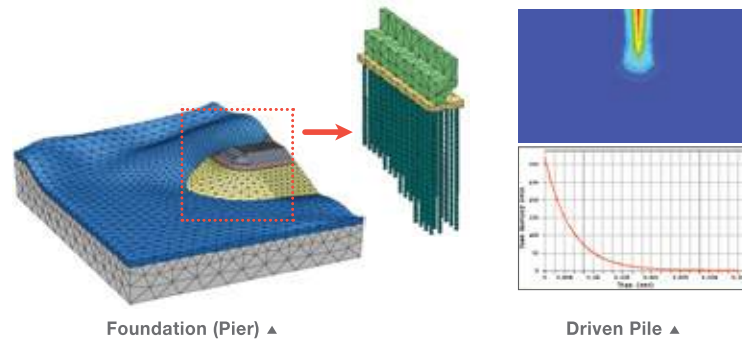

### Excavation and Temporary Structures

GTS NX simulates installation of retention walls for excavation of ground structures such as subway stations, tall building foundations. Temporary structures can be incorporated in excavation stages, which include piles, walers, struts, anchors and tie-backs. Changes in earth pressure and ground water level and complex strata can be also accommodated in conjunction with existing adjacent ground structures such as tunnels, subways, foundations and utility chambers.

**Retaining wall:** H-Pile + slurry wall, Sheet Pile, CIP, SCW, D-Wall

**Strut:** Steel Strut, Earth Anchor, Rock Bolt, Soil Nail, Tie Rod, Raker

**Stability analysis for adjacent structures**

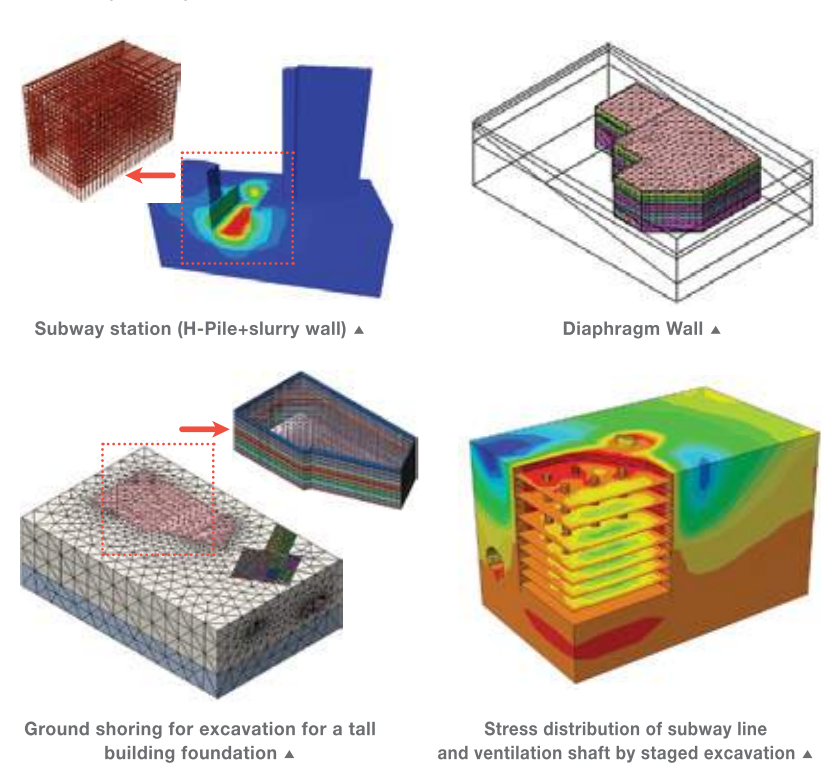

# Application Areas

| Soft Soil / Embankment |

| Hydraulic /  
Underground Structure |

## Total Solutions for Geotechnical Analysis

### Soft Soil / Embankment

GTS NX calculates dissipation of excessive pore water pressure and consolidation settlement through staged consolidation analysis. Fully coupled seepage analysis reflects changes in excessive pore water pressure and water level in real time.

**Soft soil:** SCP-reinforced, Dewatering method (PBD, PSD, SD), Suction drain

**Embankment:** Revetment and quay wall, Dock, Breakwater

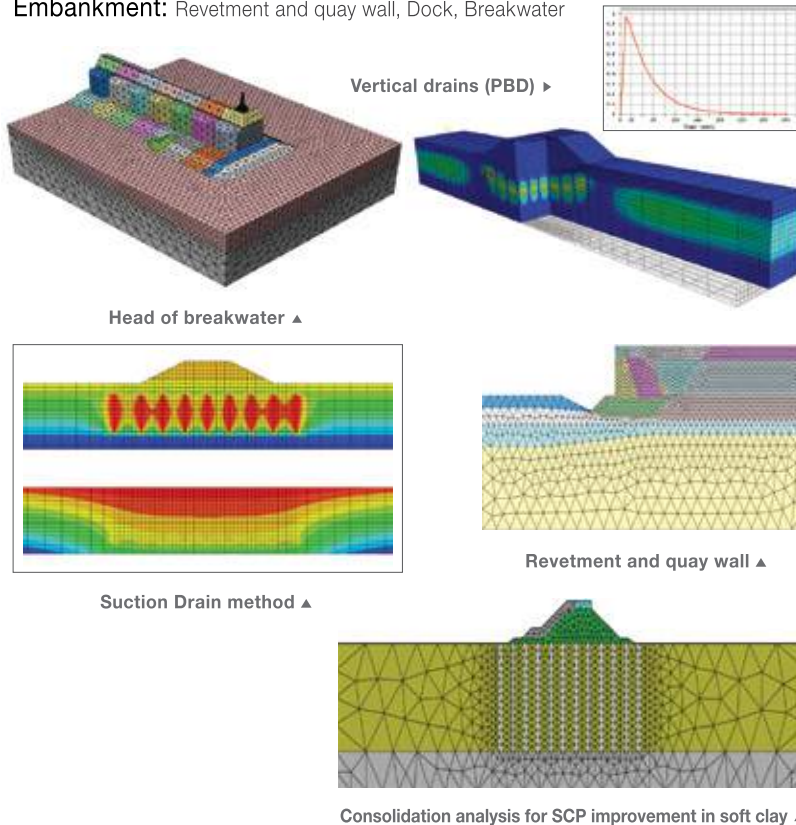

### Hydraulic / Underground Structures

Steady state and transient seepage analysis for dams, embankments, tunnels, etc. can be performed. Seepage in an unsaturated area can be also analyzed by applying Darcy's Law. GTS NX inherently handles ground – structure interaction with water and ground water related problems.

**Hydraulic structures:** Earth Dam, CFRD, Levee, Water way tunnel (pipe & culvert)

**Underground Structures:** Box, Underground driveway

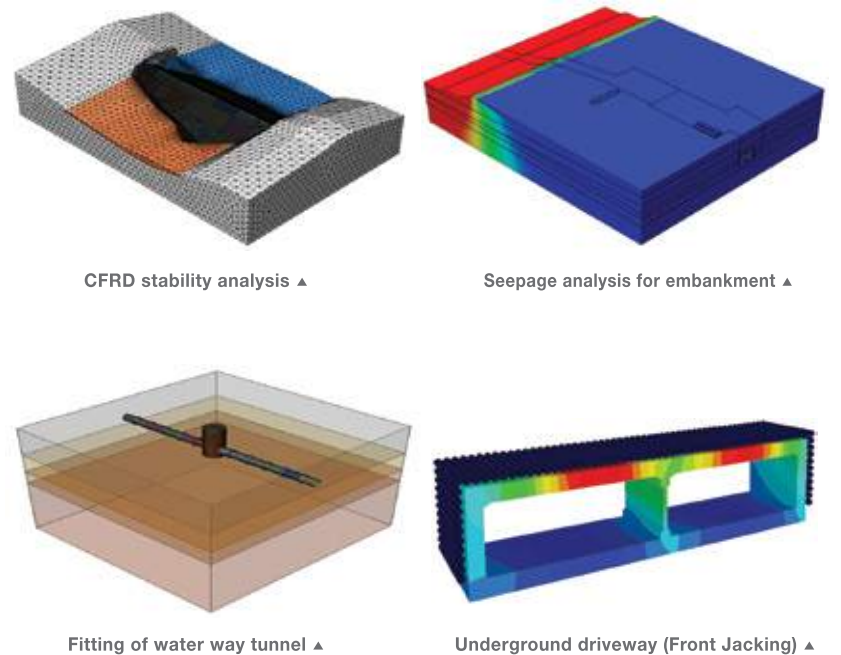

# About MIDAS IT

“MIDAS IT is taking flight with endless passion and devotion to provide technological solutions worldwide”

MIDAS Information Technology Co., Ltd. develops and supplies mechanical / civil / structural / geotechnical engineering software and provides professional engineering consulting and e-Biz total solutions. The company began its operation since 1989, and currently employs 530 developers and engineers with extensive experience. MIDAS IT also has corporate offices in US, UK, China, Japan, India and Russia. There are also global network partners in over 30 countries supplying our engineering technology. MIDAS IT has grown into a world class company.



# Introduction to MIDAS Family Programs

## MIDAS Program Applications

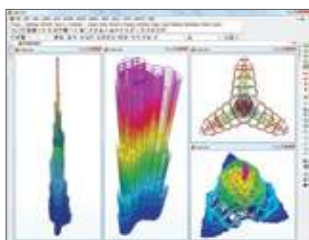

### Burj Khalifa (UAE)

- World's tallest building to date
- Height: 840m, 168 floors

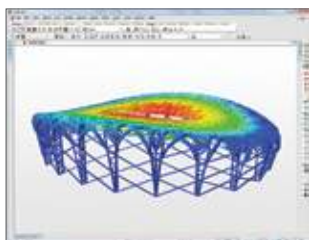

### Beijing Olympic Main Stadium (China)

- Area: 78,000 sq. m.
- Allowed Seating Capacity: 91,000 people

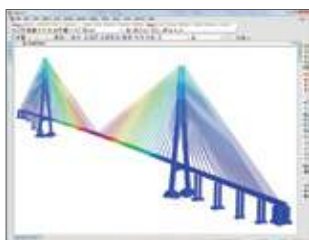

### Russky Island Bridge (Russia)

- World's longest cable stayed bridge
- Main span: 1,104m

“MIDAS Family Programs are advanced CAE (Computer Aided Engineering) solutions that have been and are being developed using the latest technology”

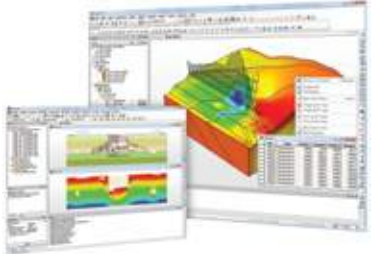
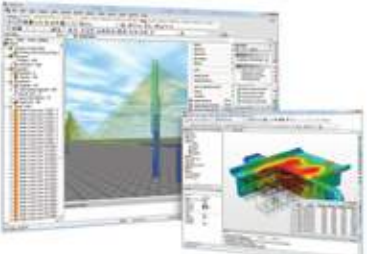
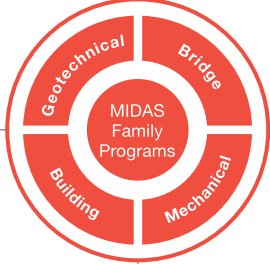
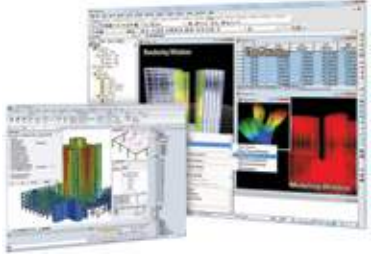
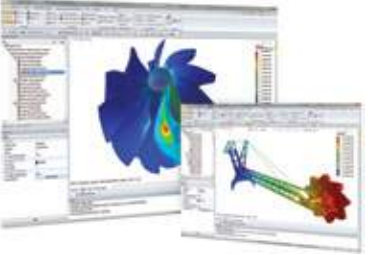
<p><b>GTS NX</b> GeoTechnical analysis System</p> <p><b>SoilWorks</b> Geotechnical Solutions for practical Design</p> 	<p><b>midas Civil</b> Integrated Solution System for Bridge and Civil Structures</p> <p><b>midas FEA</b> Advanced Nonlinear and Detailed Analysis System</p> 
	
<p><b>midas Gen</b> Integrated System for building and General Structures</p> <p><b>midas DShop</b> Auto-Drawing Module to generate Structural drawings and Bill of Materials</p> <p><b>midas Design+</b> Structural engineer's tools</p> 	<p><b>midas NFX</b> Total Solutions for Mechanical Engineering in structural mechanics and CFD</p> <p><b>midas FX+</b> General Pre &amp; Post Processor for Finite Element Analysis</p> 

# GTS NX

Integrated Solver Optimized for the next generation 64 - bit platform  
Finite Element Solutions for Geotechnical Engineering



Copyright © Since 1989 MIDAS Information Technology Co., Ltd. All rights reserved.  
[www.MidasUser.com](http://www.MidasUser.com)

<http://www.midasGTSNX.com>