



# JI SLATE 1000SF PIR

Installation guide

MR078 / 1122

# Jl SLATE 1000SF PIR

## Index

Technical data sheet	2
Jl Slate 1000SF PIR	2
Jl Sidings 1000SF PIR	3
Wall application	4
Step 1	5
Step 2	5
Step 3	6
Step 4	6
Step 5	7
Step 6	7
Step 7	8
Step 8	9
Step 9	10
Roof application	12
Step 1	12
Step 2	12
Step 3	13
Step 4	13
Step 5	13
Step 6	14
Step 7	14
Legend	16
Accessories	17

## Installation guide

Jl Slate 1000SF PIR offers a high-quality, ready-made solution for an insulated façade with slates. If you prefer a façade consisting of weatherboarding, our Jl Sidings 1000SF PIR would be great for you.

The Jl Slate 1000SF PIR and Jl Sidings 1000SF PIR can be used as both roof and wall applications.

Joris Ide has over 30 years of experience and is a quality label within the construction sector. We provide your building with the best finish, with a wide range of accessories tailored to your project. Joris Ide, the ideal partner for all your projects.

Detail Jl Slate 1000SF PIR.



Jl Slate 1000SF PIR as wall application.

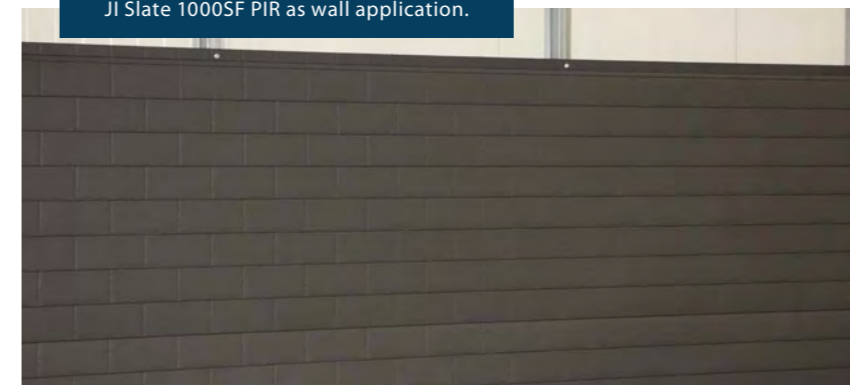

Overlap detail.

For standard accessories, refer to page 17.

Joris Ide NV is not responsible for printing errors and / or any differences between the images in this catalogue and the final product delivered. Joris Ide NV reserves the right to modify the technical specifications at any time without prior notice. To make sure you have the latest version, we invite you to scan this QR code to download the latest version from our website [www.jorisode.com](http://www.jorisode.com).



## Technical data sheet

### JI Slate 1000SF PIR

JI

The JI Slate 1000SF PIR is an insulated panel with PIR foam core. The secret-fix design of this wall or roof panel provides hidden fixation for a seamless transition between the panels, which results in a superbly smooth wall or roof aesthetic.

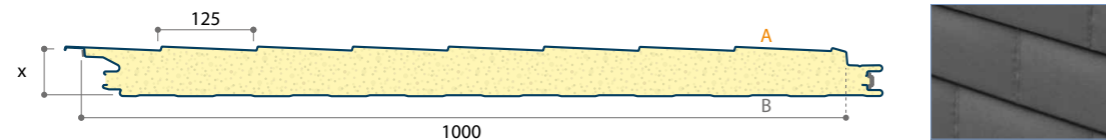
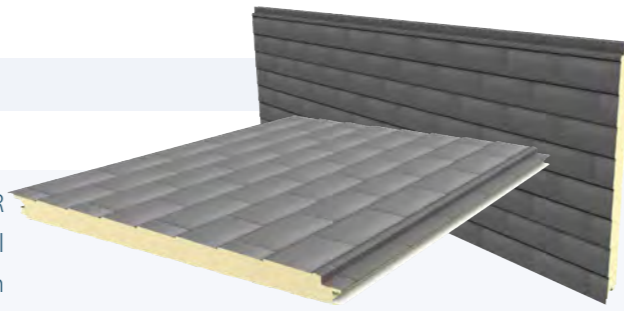

Article	Thickness (mm)	Weight (kg/m <sup>2</sup> )	U (W/m <sup>2</sup> K)
10451	60	10,44	0,39
10452	120	12,72	0,19

Calculated in accordance to European product standard BS EN 14509.

## Technical information

Standard length	from 2500 to 10000 mm (step 500 mm)
Standard Width	1000 mm
Metal type	Steel S250 GD
Outer sheet (A)	slate gray sheet steel (125 x 250mm), thickness 0,50mm
Coating outer sheet	Grandemat (40µ) RAL 7024 see brochure MR101_Colorflow
Inner sheet (B)	standard liner profiled steel (linear), thickness: 0,40 mm, RAL 9002 (15µ) standard
Fastening	Concealed - Mandatory mounting with load distribution plate
Minimum roof slope	≥ 25°
Installation	horizontal
Purlin distance	1500 mm
Accessories	panel bearer, fixings, JI Sealant, internal and external corner flashing, T-profile JI Slate Kit, ridge flashings and small and big gable rake flashing

Reference standards		Insulation	
Galvanized steel	BS EN 10346 – normal Tolerances according to BS EN 10143	Core	Polyisocyanurate foam core (PIR), density: 40±5 kg/m <sup>3</sup> without CFC-HCFC
Prepainted	BS EN 10169 Hot-dip galvanizing applied	Fire classification	B-s2,d0 according to BS EN 13501-1
Product standard	BS EN 14509		

### Advantages

- low weight, light substructure
- high heat output
- quick assembly
- unique finish with no visible screws

## Technical data sheet

### JI Sidings 1000SF PIR

The JI Sidings 1000SF PIR is an insulated panel with PIR foam core. The secret-fix design of this wall panel provides hidden fixation for a seamless transition between the panels, which results in a superbly smooth wall aesthetic.

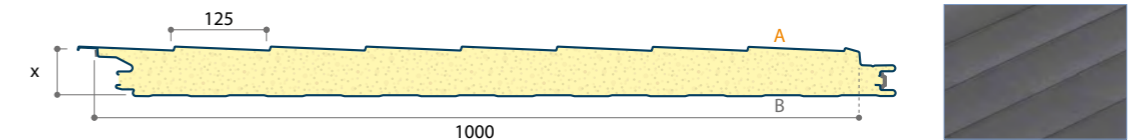

Article	Thickness (mm)	Weight (kg/m <sup>2</sup> )	U (W/m <sup>2</sup> K)
10451	60	10,44	0,39
10452	120	12,72	0,19

Calculated in accordance to European product standard BS EN 14509.

## Technical information

Standard length	from 2500 to 10000 mm
Standard Width	1000 mm
Metal type	Steel S250 GD
Outer sheet (A)	Sheet steel with plank pattern (125 x 250mm), thickness 0,50mm
Coating outer sheet	Grandemat (40µ) RAL 7024 see brochure MR101_Colorflow
Inner sheet (B)	standard liner profiled steel (linear), thickness: 0,40 mm, RAL 9002 (15µ) standard
Fastening	Concealed - Mandatory mounting with load distribution plate
Minimum roof slope	≥ 25°
Installation	horizontal
Purlin distance	1500 mm
Accessories	panel bearer, fixings, JI Sealant, internal and external corner flashing, T-profile JI Slate Kit, ridge flashings and small and big gable rake flashing

Reference standards		Insulation	
Galvanized steel	BS EN 10346 – normal Tolerances according to BS EN 10143	Core	Polyisocyanurate foam core (PIR), density: 40±5 kg/m <sup>3</sup> without CFC-HCFC
Prepainted	BS EN 10169 Hot-dip galvanizing applied	Fire classification	B-s2,d0 according to BS EN 13501-1
Product standard	BS EN 14509		

### Advantages

- low weight, light substructure
- high heat output
- quick assembly
- unique finish with no visible screws

## JI Slate / Sidings 1000SF PIR - Wall application

We explain below how to install JI Slate 1000SF PIR or JI Sidings 1000SF PIR. JI Slate 1000SF PIR can be used as finishing for various primary structures because of the convenient assembly using omega profiles.

### Steel frame (also available from Joris Ide)



The product is thus ideally suited both for new-build and renovation projects! Below we show how it is assembled against a steel frame. The assembly method for all frames is the same due to the use of omega profiles.

### Masonry using (cellular) concrete

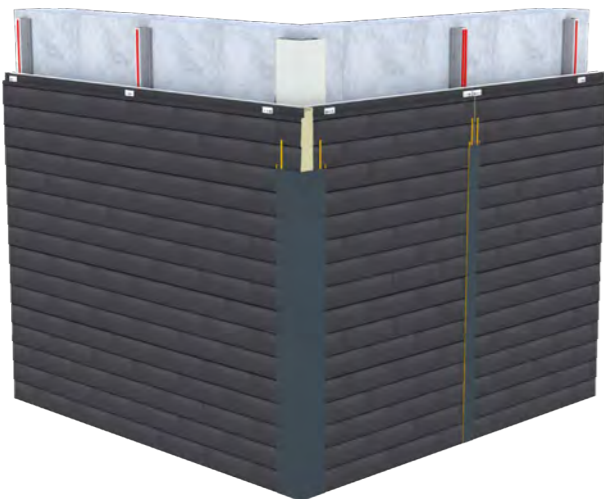

### Masonry using quick building blocks



## Step 1

### Primary frame: Steel frame



### Detail steel frame with a C-profile



The primary frame is designed according to the rules of the art. The underside of the steel frame is fitted with a C-profile, to which the horizontal omega profile can be secured. The C-profile is mainly recommended as a support for the horizontal omega profile when the columns are spaced apart at a greater distance.

## Step 2

### Omega profiles

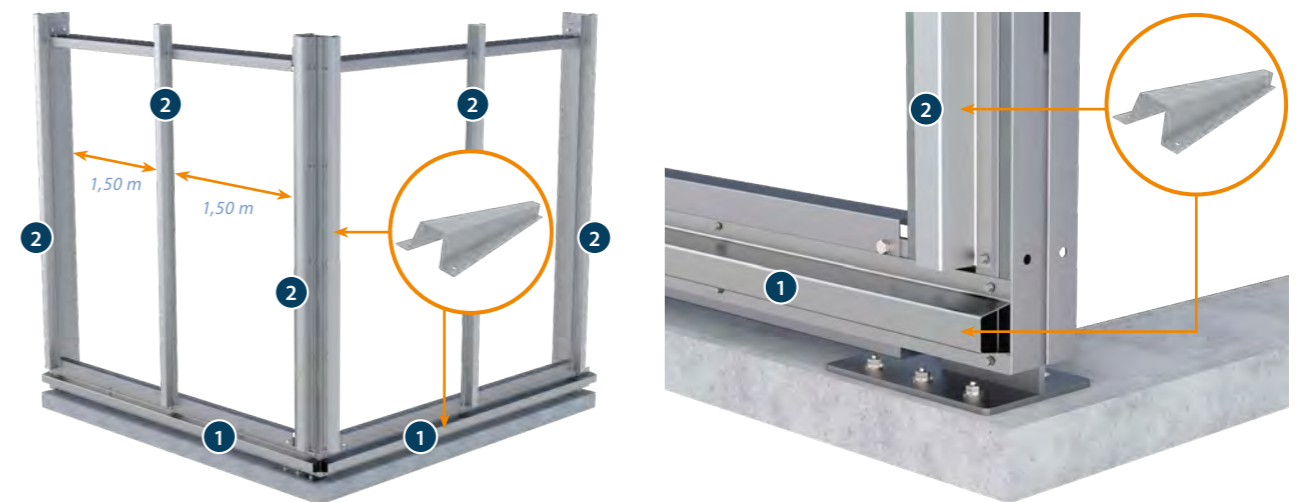

The first step consists of the installation of the Joris Ide omega profiles. These constitute the basis for the flat underframe to which the panels will be secured and must therefore be installed with great care. First the horizontal bottom profile ① is secured, followed by the vertical profiles ②. The distance between the vertical profiles may be no greater than 1.50 m.

## JI Slate / Sidings 1000SF PIR - Wall application

### Step 3

#### Panel bearer

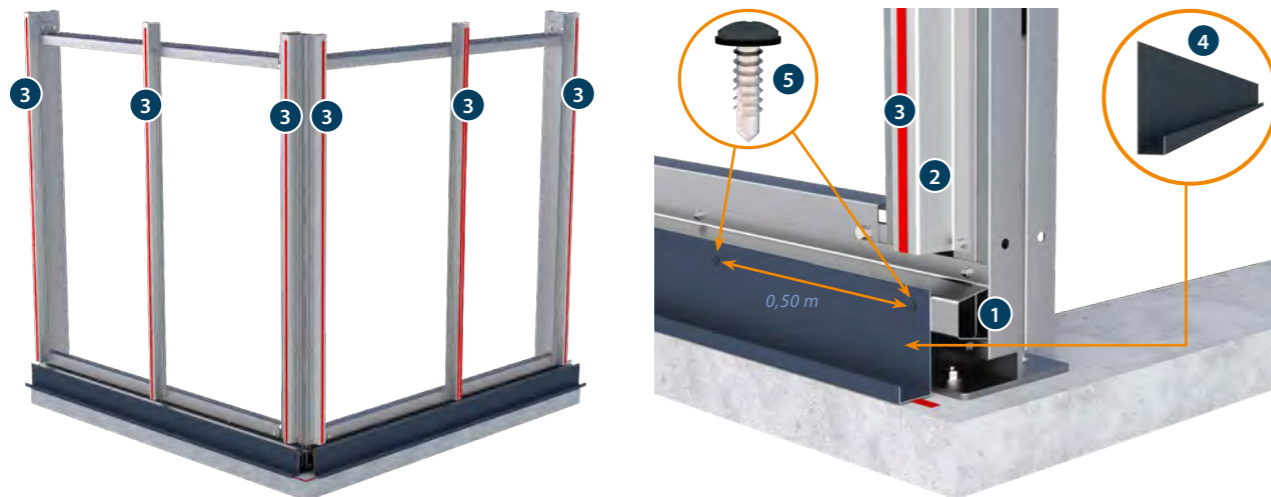

After mounting the vertical omegas (2), the JI Sealant (3) is applied. This ensures a vapor-tight seal between the structure and the panel and reduces contact noise. Then the panel bearer (4) can be confirmed. Fastening is carried out every 0.50 m with Torx screws (4.8 x 35 mm) (5). Thanks to the omega, the start profile remains nice and straight, which makes sliding the panel easier.

### Step 4

#### Protective film



Before the JI Slate 1000SF PIR panel (6) is lifted the plastic protective film must be peeled back 5 cm from the panel's edge to ensure that the film can be fully removed after installation.

#### Lifting JI Slate 1000SF PIR



The panel is then raised to an upright position on soft protective blocks to avoid damage and is lifted for assembly.

### Step 5

#### JI Slate 1000SF PIR in panel bearer



JI Slate 1000SF PIR (6) is deposited in the panel bearer (4) and slid into place horizontally.



- a Horizontal omega
- b Vertical omega
- c Panel bearer
- d Torx screws (every 0.50 m)
- e JI Sealant
- f JI Slate 1000SF PIR

### Step 6

#### Check positioning bottom panels



The panel's horizontal and vertical positioning are checked after which the panel is secured with metal screws (7).

#### Positioning of the panels above

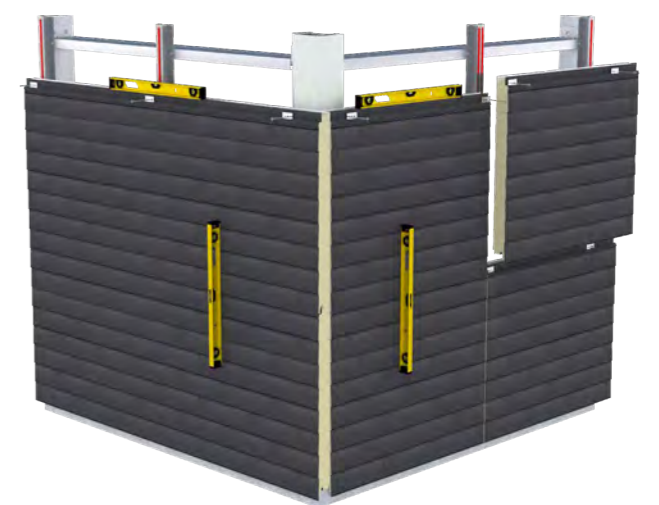

Once the bottom panels have been assembled, the next layer is installed.

## JI Slate / Sidings 1000SF PIR - Wall application

### Detail



It is important that you check, before the panels are clicked in place, that the joint between the slates is vertically aligned.

- a level
- b panel to be installed
- c installed panel

### Step 7

Secret fix: position before the panel is clicked in place

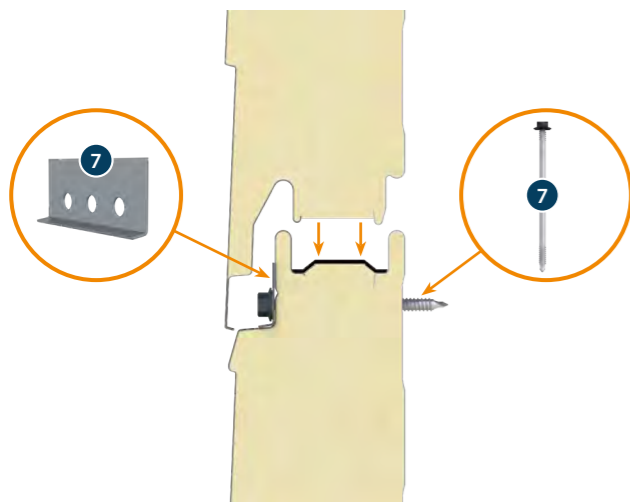

After alignment of the top panel, it can be pressed down to close the hidden fixing. The panel is then secured with pressure distribution plates and metal screws 7.

Secret fix: position after the panel is clicked in place

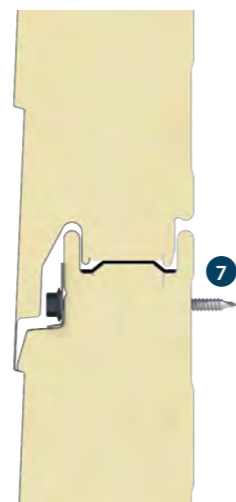

### Step 8

Detail connections  
Finishing trim

Finish external corner flashing

Joris Ide has several accessories for finishing the thermal bridges of your building, including the internal corner flashing 8, the external corner flashing 9 and the T-profile 10.



Internal corner flashing 8 is fastened to the omega profiles on the corner of a building using torx screws 5. The panels are then installed right up to the corner. To reduce the risk of cold bridging, the inner face of the continuous panel can be interrupted (local removal of the internal liner, depending on panel thickness 60 or 120 mm). To make the corner water and airtight, when installing an external corner flashing 9, apply two lines of JI Slate Kit 11 to the JI Slate 1000SF PIR panel 6 recommend using two torx screws 5 per metre as shown below. The external corner flashing ensures a smooth transition between walls.

Cross-section corner

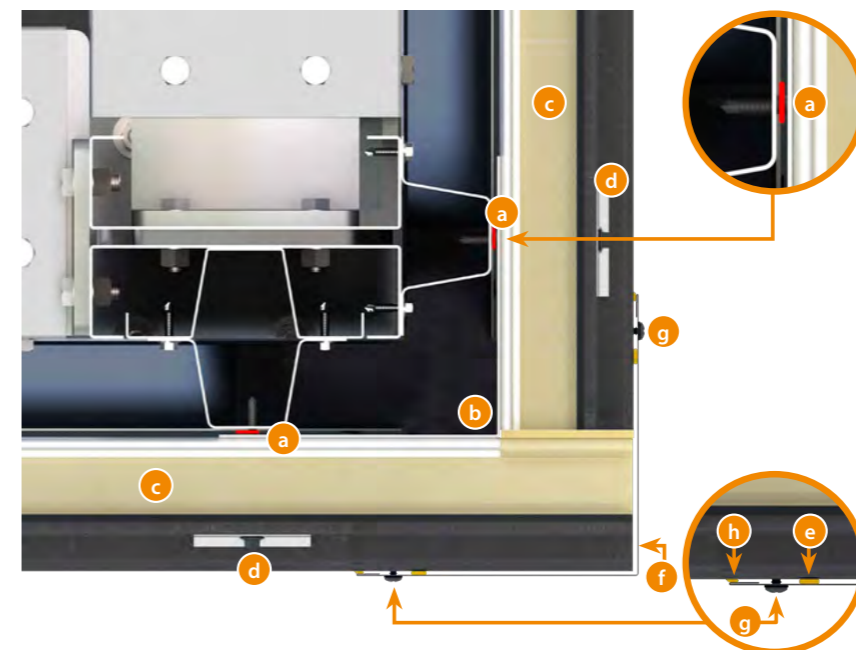

Assembly screws

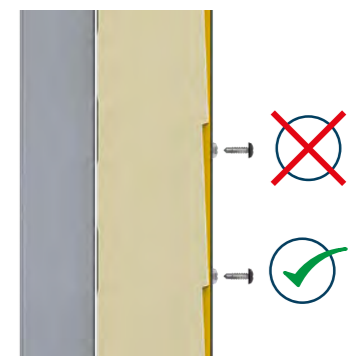

- a JI Sealant
- b Internal corner flashing
- c JI Slate 1000SF PIR
- d Pressure distribution plate + metal screw
- e JI Slate kit
- f External corner flashing
- g Torx screws
- h JI Slate Kit

## JI Slate / Sidings 1000SF PIR - Wall application

### Step 9

#### T-profile

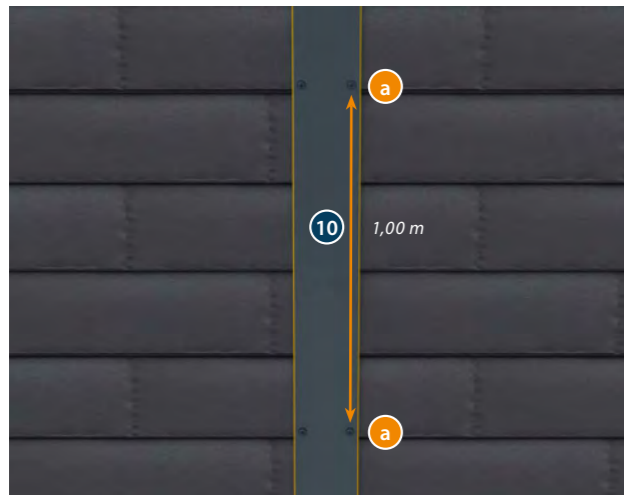

#### Front view

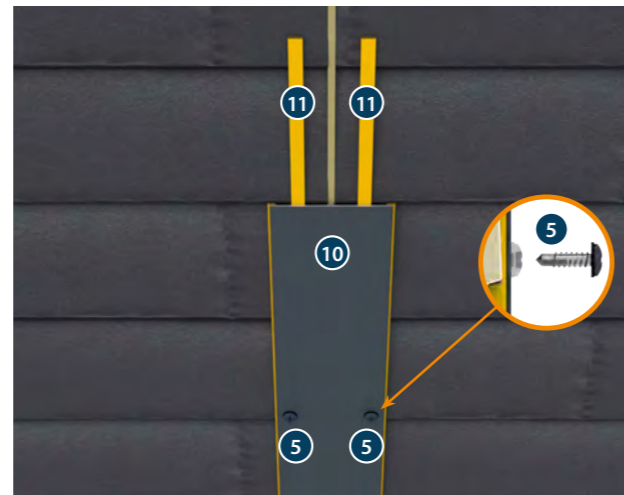

Two lines of JI Slate Kit 11 must be applied after which the T-profile 10 is installed. The T-profile is then secured with two torx screws 5 every metre in the designated place a. The seam must be sealed with JI Slate Kit.



JI Slate 1000SF PIR, detail overlap.

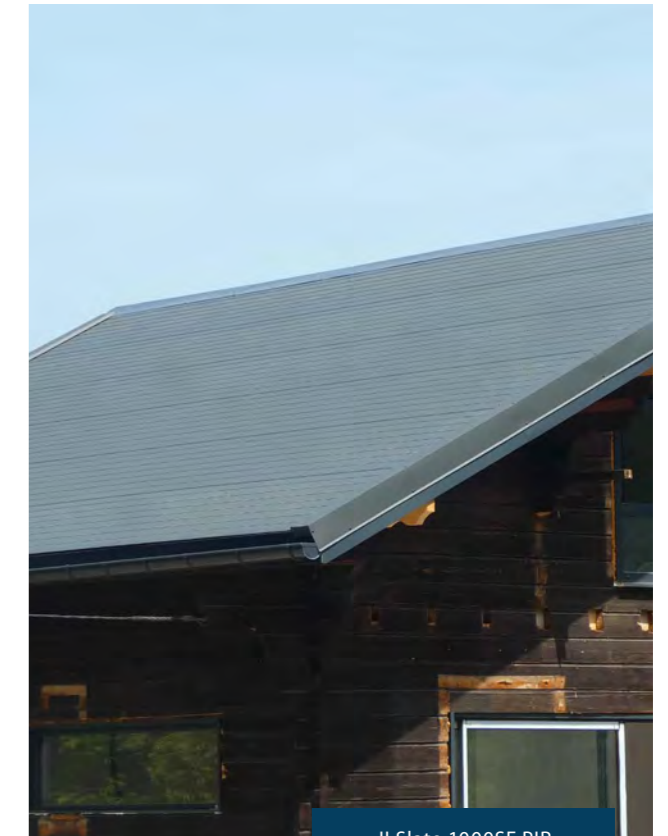

JI Slate 1000SF PIR

#### Cross-section

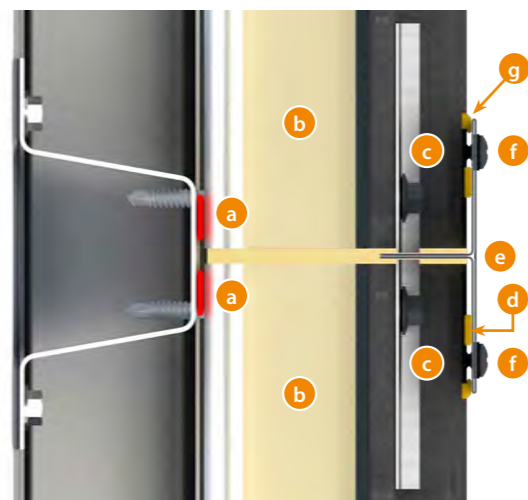

- a JI Sealant
- b JI Slate 1000SF PIR
- c Pressure distribution plate + metal screw
- d JI Slate Kit
- e T-profile
- f Torx screws
- g JI Slate Kit

#### T-profile and external corner flashing

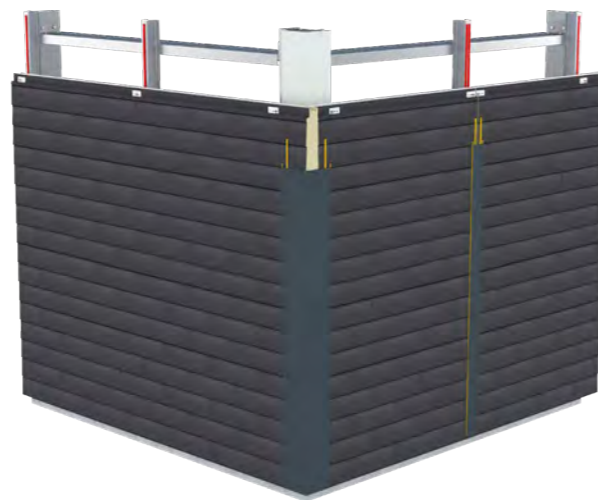

If you follow the above instructions, you will achieve a façade with a superbly smooth aesthetic using JI Slate 1000SF PIR panels.



Aesthetic results regardless of the application.

## JI Slate / Sidings 1000SF PIR - Roof application

### Step 1

#### Roof structure

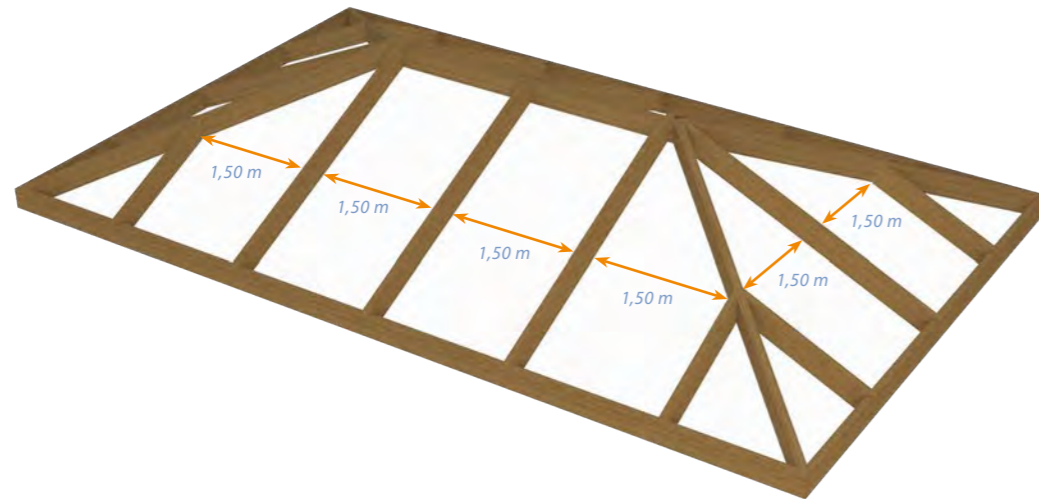

The installation of JI Slate 1000SF PIR on roofs is similar to that of the wall application. The maximum distance between the vertical supports is 1.50 m. The minimum roof slope is 25° (or 46.6 cm/m).

### Step 2

#### Panel bearer

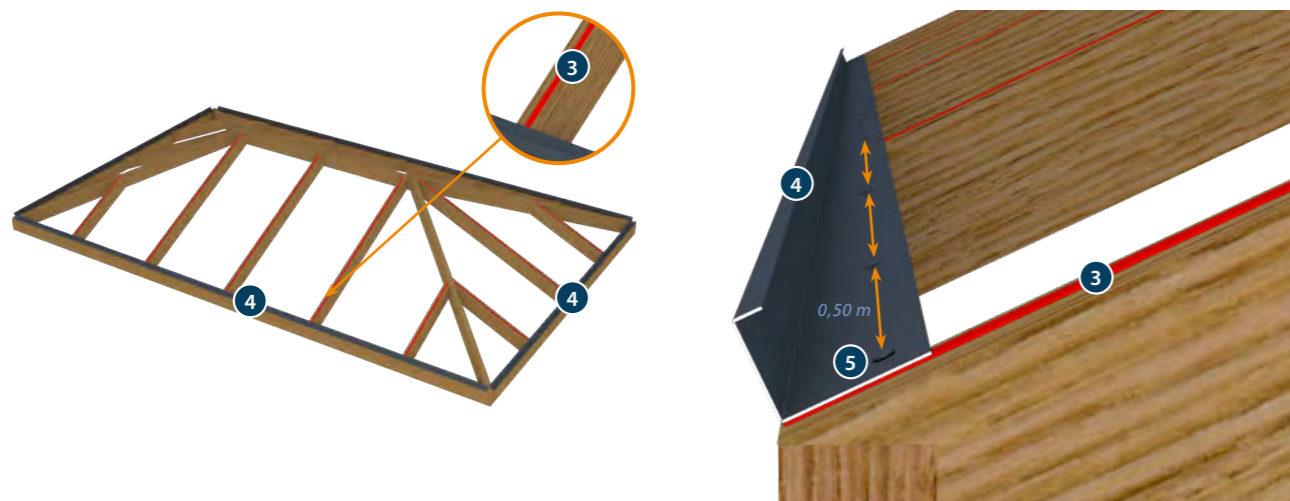

Once the truss structure has been assembled, the panel bearer 4 can be installed. This profile must be secured every 0.50 m with torx screws 5. JI Sealant strips 3 are used to reduce noise transmission between the purlin and the panel.

### Step 3

#### JI Slate 1000SF PIR in panel bearer

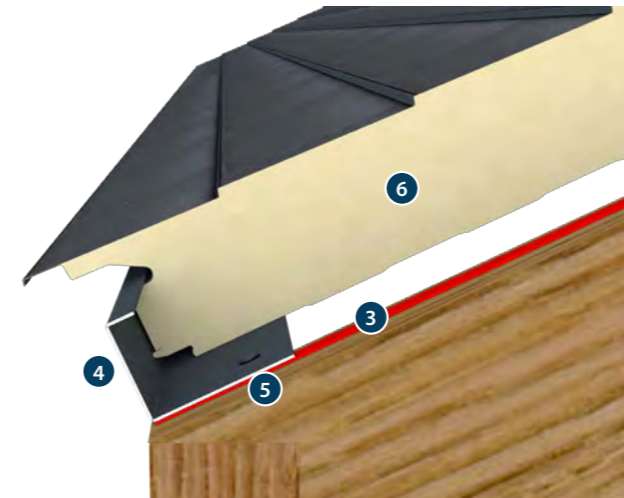

The first JI Slate 1000SF PIR panel 6 can then be installed. Note that the panel bearer 4 also serves as trim for the eaves.

### Step 4

#### Corner trim for a roof with a rake

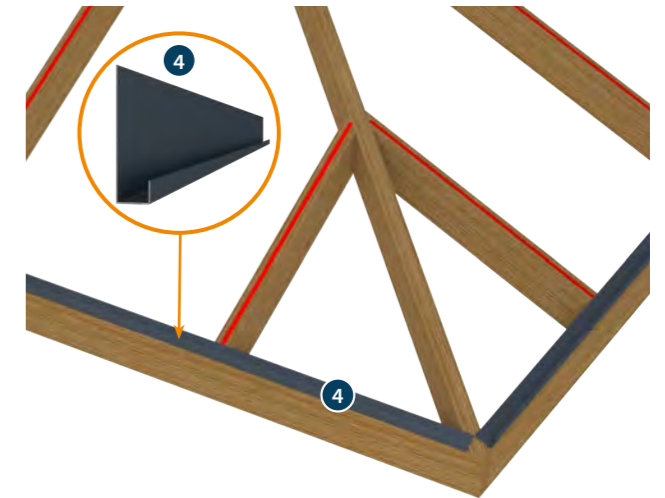

Depending on the roof type and shape, the panels will have to be cut. When cutting, you must take the relative positioning of the JI Slate 1000SF PIR panels into account.

Thanks to the placement of the panel bearer 4, the corner panel can easily be slid into place and cut to the required size.

### Step 5

#### Position of the panels

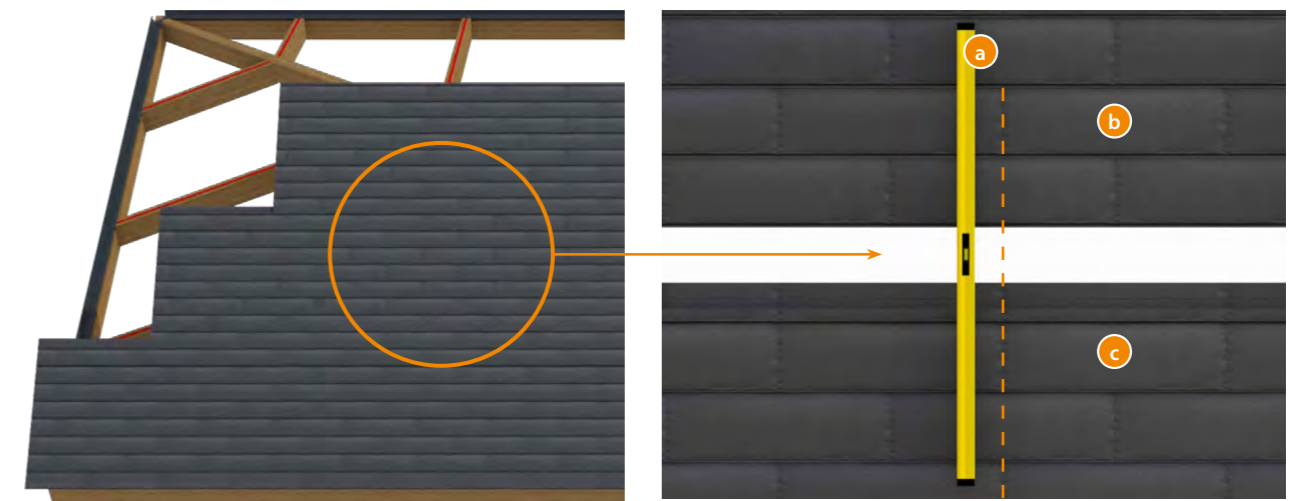

a level  
b panel to be installed  
c installed panel



## JI Slate / Sidings 1000SF PIR - Roof application

### Step 6

#### Cutting the panels

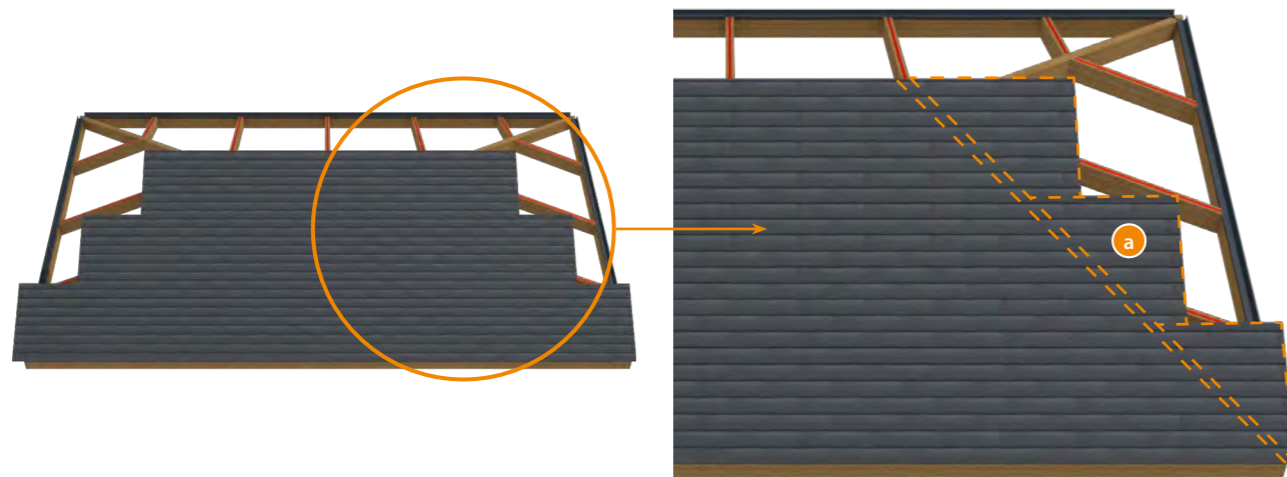

The full panel lengths are laid on the roof one by one.

**a** Cutting the panels

### Step 7

#### Ridge

#### Finished roof

All the connections between the panels can be finished with the appropriate accessories. As is the case with wall application, cold bridges must be sealed.

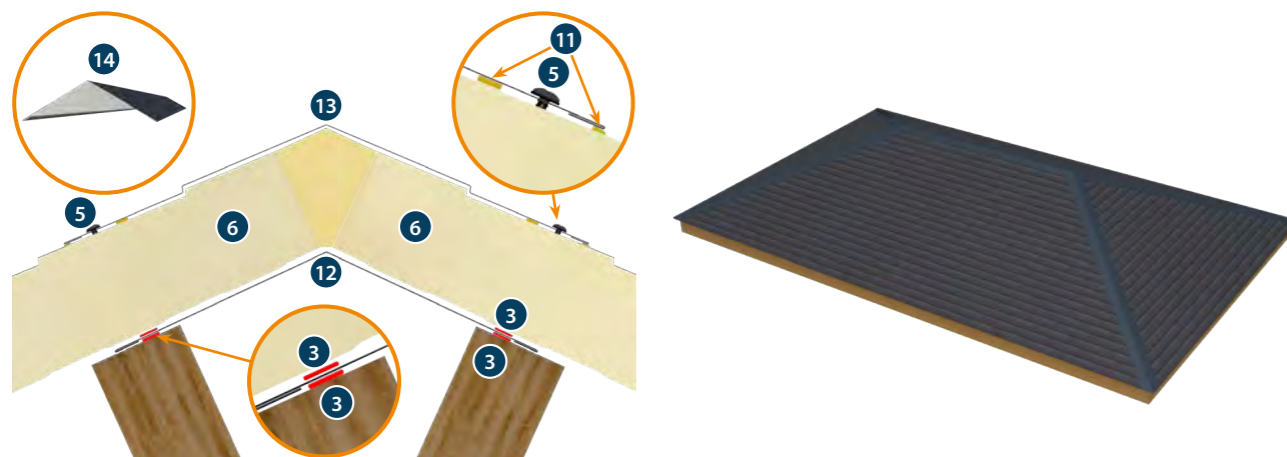

Internal ridge flashing **12** is installed on the ridge. This is installed on top of the JI Sealant **3**. The last roof panels **6** are then installed. To finish the ridge, use an external ridge flashing with JI Slate effect **13** or an external reinforced flat ridge flashing **14**. The finishing with torx screws **5** and the use of JI Slate Kit **11** is similar to the installation of the trim for wall applications.











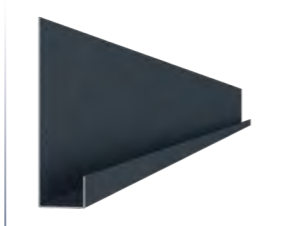

The roof edges are also finished with edge trims.

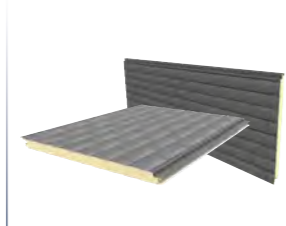

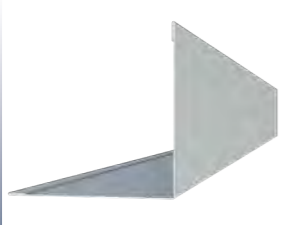
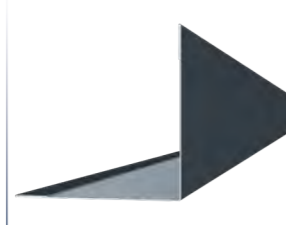
JI Slate 1000SF PIR

## Legend

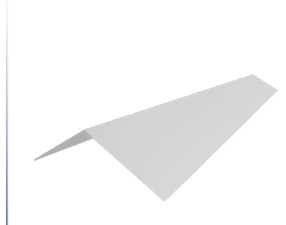

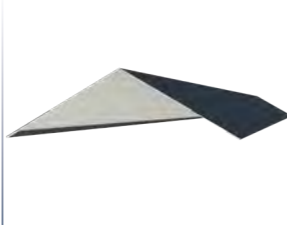

### Overview

 Omega profile (reference 1 and 2)	 JI Sealant (15 x 4,5 mm) (reference 3)	 Panel bearer for 60 mm panel (reference 4)	 Panel bearer for 120 mm panel (reference 4)
 Torx screw (4,8 x 35 mm) (reference 5)	 JI Slate 1000SF PIR panel (reference 6)	 JI Sidings 1000SF PIR panel (reference 6)	 Pressure distribution plate (reference 7)
 Internal corner flashing (reference 8)	 External corner flashing Dev. 240 mm (reference 9)	 External corner flashing Dev. 400 mm (reference 9)	 T-profile (reference 10)
 JI Slate Kit (reference 11)	 Internal ridge flashing (reference 12)	 External ridge flashing with JI Slate effect (reference 13)	 External reinforced flat ridge flashing (reference 14)

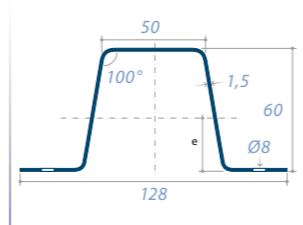
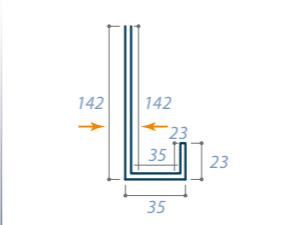
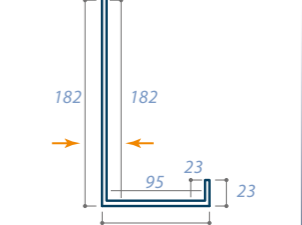
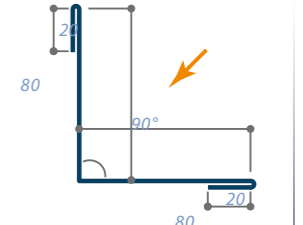
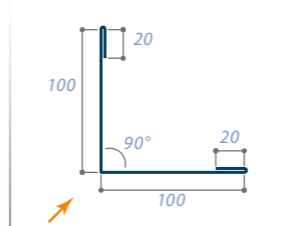
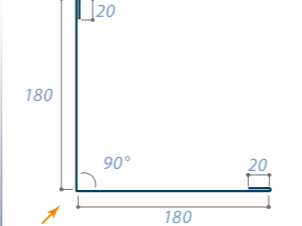
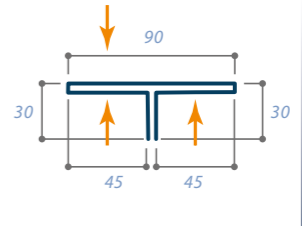
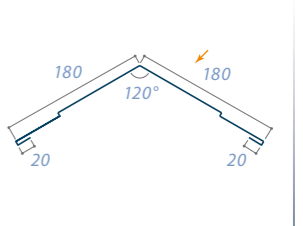
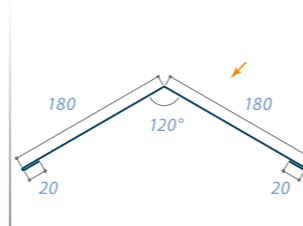
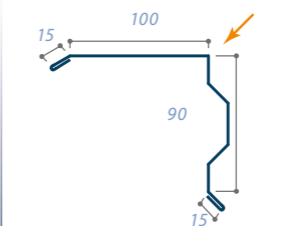
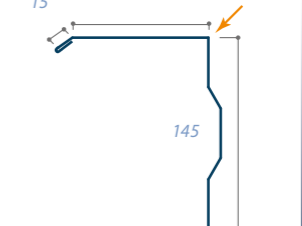
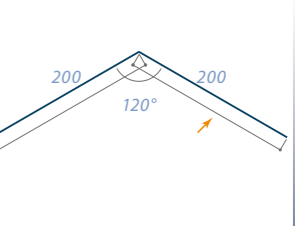

## Accessoires

### Standard\*

Joris Ide provides the best finish for your building with a wide range of accessories that are tailored to your project.

 Omega profile Article 301 - 4030 mm length Article 303 - 6030 mm length	 Panel bearer JI Slate/Sidings for 60 mm panel Article 12170 - 3000 mm length	 Panel bearer JI Slate/Sidings for 120 mm panel Article 12171 - 3000 mm length	 Internal corner flashing Article 896 - 3000 mm length
 External corner flashing 100/100 Article 819 - 3000 mm length	 External corner flashing 180/180 Article 815 - 2100 mm length	 T-profile JI Slate/Sidings Article 12169 - 4000 mm length	 External ridge flashing with JI Slate effect Article 11267 - 2250 mm length
 External reinforced flat ridge flashing Article 812 - 2100 mm length	 Small gable rake flashing Article 2854 - 2100 mm length	 Big gable rake flashing Article 7631 - 2100 mm length	 Ridge Lower Side White - Ral 9002 Article 728 - 2100mm length
 JI Sealant (15 x 4,5 mm - 20m/roll) Article 4036293	 Torx screw (4,5 x 35 mm) RAL 7024 - Article 4036490	 Pressure distribution plate Article 4002644	 Touch up paint 0,25 L RAL 7024 matt Article 4005013

\*Customisation on request.

 Bits 10 mm Article 4000170	<b>Fixing screws</b>			 JI Slate Kit Article 4036750
		Wood	Metal < 2,5 mm	
	JI Slate 60 mm	A 80	BZB 80 reducing	BZB 85
	JI Slate 120 mm	A 150	BZB 125 reducing	BZB 145



# JORISIDE

THE STEEL FUTURE

## Joris Ide Ltd.

A9, Elmbridge Court,  
Gloucester GL3 1JZ, United Kingdom

☎ +44 (0)1452 412 069

☎ +44 (0)1452 358 025

✉ [sales@joriside.co.uk](mailto:sales@joriside.co.uk)

## Joris Ide nv/sa

Hille 174,  
8750 Zwevezele, Belgium

☎ +32 (0)51 61 07 77

☎ +32 (0)51 61 07 79

✉ [info@joriside.be](mailto:info@joriside.be)



With more than 30 years of experience, Joris Ide represents a guarantee of quality in the construction market. We provide solutions in all fields: acoustic, aesthetic, fire, thermal. Joris Ide, the essential partner for all your projects.

JORIS IDE IS  
PLANET  
PASSIONATE

