



JCPT0807DC

Dingli









Electric scissor lift JCPT0807DC

Electric scissor lift JCPT0807DC

STANDARD EQUIPMENT

- Proportional controls
- Automatic pothole protection
- Self-lock gate on platform
- Drivable at full height
- Non marking tires
- 2 WD
- Automatic brakes
- Emergency lowering system
- Emergency stop buttons
- Cylinder holding valve
- Onboard diagnostic system
- Overload sensor with alarm
- Tilt sensor with alarm
- All motion alarm
- Horn
- Hour meter
- Safety brackets
- Forklift pockets
- Folding guardrails
- Extended platform
- Charger protection
- Flashing beacon

SPECIFICATIONS

	Platform capacity (SWL).....	230 kg
	Platform capacity (SWL) on extension.....	113 kg
	Maximum workers number.....	2
	Working height.....	7,8 m
	Platform floor height.....	5,8 m
	Overall length.....	1,86 m
	Overall width.....	0,76 m
	Overall height (Rails up).....	2,18 m
	Overall height (Rails down).....	1,84 m
	Platform size.....	1,67 x 0,74 m
	Platform extension size.....	0,9 m
	Ground clearance (Stowed).....	0,083 m
	Ground clearance (Raised).....	0,016 m
	Wheelbase.....	1,38 m
	Turning radius (inside).....	0 m
	Turning radius (outside).....	1,64 m
	Drive motors.....	24 V / 0,5 kw
	Lifting motor.....	24 V / 2 kw
	Travel speed (Stowed).....	5 km / h
	Travel speed (Raised).....	0,8 km / h
	Up / Down speed.....	27 / 22 sec
	Batteries.....	4 x 6 V / 185 Ah
	Integrated charger.....	24 V / 25 A
	Gradeability.....	25 %
	Maximum working slope.....	2 - 3 °
	Tires.....	Ø 305 x 100 mm
	Weight.....	1415 kg

OPTIONS

- Platform work lights
- Airline to the platform
- AC power to the platform

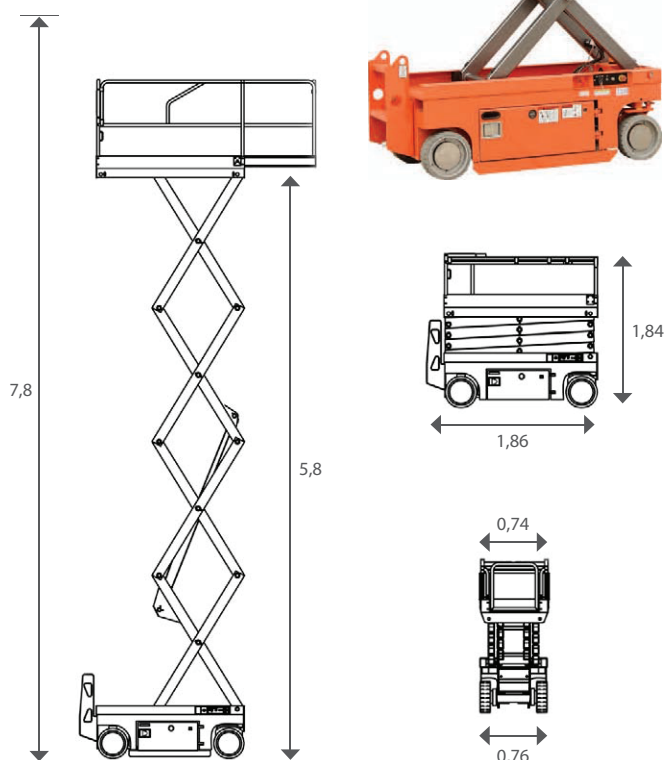

CE This product is available with the CE mark confirming compliance with all relevant European Machinery Directives

www.dingli.eu

INSTANT

Norway
Tel.: +47 23 19 11 00
info@instant.no

Lithuania
Tel.: +370 5 233 1096
info@instant.lt

Latvia
Tel.: +371 263 58 152
info@instantlatvija.lv

Estonia
Tel.: +372 680 76 33
info@instant.ee