

STRUCTURAL DECKING

Designer's guide

MR024 / 0921

JORISIDE
THE STEEL FUTURE



Index

JI decks	2	JID decks - Steel	35
JID decks	3	JID 50-250-1000	36
Membrane Roof System	4	JID 50-250-1000 Perfo Flange	37
Standing Seam System	4	JID 50-250-1000 Perfo Web	38
Green Roofs	4	JID 85-280-1120	39
Perforation patterns	5	JID 85-280-1120 Perfo Web	40
Mounting instructions	6	JID 89-305-915	41
Diaphragm	7	JID 89-305-915 Perfo Web	42
Extended end laps	8	JID 100-275-825	43
		JID 100-275-825 Perfo Web	44
		JID 106-250-750	45
		JID 106-250-750 Perfo Web	46
JID decks - Steel	9	JID 137-310-930	47
JI 35-207-1035 R	10	JID 137-310-930 Perfo Web	48
JI 35-207-1035 R Perfo Flange	11	JID 153-280-840	49
JI 37-265-1060	12	JID 153-280-840 Perfo Web	50
JI 42-252-1010	13	JID 158-250-750	51
JI 42-252-1010 Perfo Web	14	JID 158-250-750 Perfo Web	52
JI 42-252-1010 Perfo Full	15	JID 200-375-750	53
JI 56-225-900	16	JID 200-375-750 Perfo Web	
JI 56-225-900 Perfo Web	17	R5T14 DO	54
JI 56-225-900 Perfo Full	18		
JI 73-195-780	19	JID decks - Aluminum	57
JI 73-195-780 Perfo Web	20	JID Alu 85-280-1120	58
JI 73-195-780 Perfo Full	21	JID Alu 85-280-1120 Perfo Web	59
JI 85-280-1120	22	JID Alu 137-310-930	60
JI 85-280-1120 Perfo Web	23	JID Alu 137-310-930 Perfo Web	61
JI 106-250-750	24	JID Alu 153-280-840	62
JI 106-250-750 Perfo Web	25	JID Alu 153-280-840 Perfo Web	63
JI 113-320-960	26	JID Alu 158-250-750	64
JI 113-320-960 Perfo Web	27	JID Alu 158-250-750 Perfo Web	65
JI 137-310-930	28	JID Alu 200-375-750	66
JI 137-310-930 Perfo Web	29	JID Alu 200-375-750 Perfo Web	
JI 153-280-840	30	(R5T14-DO)	67
JI 153-280-840 Perfo Web	31		
JI 158-250-750	32		
JI 158-250-750 Perfo Web	33		



Joris Ide NV is not responsible for printing errors and / or any differences between the images in this catalogue and the final product delivered. Joris Ide NV reserves the right to modify the technical specifications at any time without prior notice. To be sure you have the latest version of this brochure, look on our website

STRUCTURAL DECKING

Designer's guide

The Joris Ide Group is one of the largest independent European producers of insulated and non-insulated cladding systems and components. Its product range varies from single skin profiles to continuous produced PIR and Rockwool composite panels, purlins, flashings, rainscreen cladding and structural metal decking.

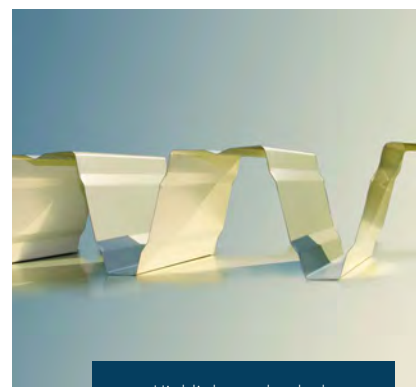
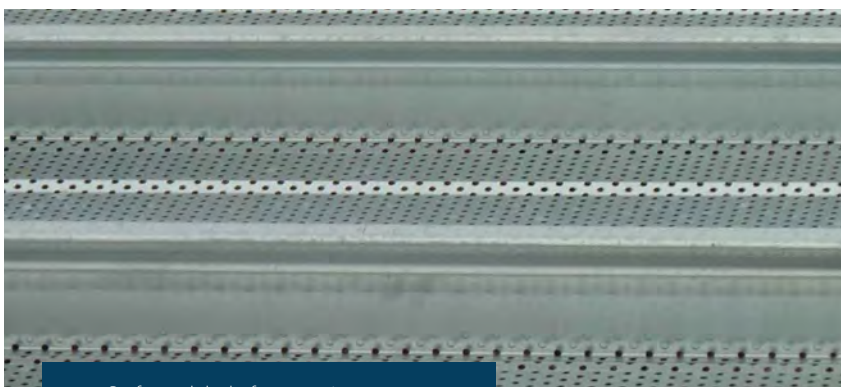

Metal decking is used in commercial and industrial applications for a built-up flat or low pitched roof. In combination with site-applied insulation the metal deck has all capacity to be used in for standing seam, single skin profiles or roof membrane projects.

The wide variety of deck finishes, thicknesses of material and perforation patterns allow Joris Ide to offer the customer the best economic solution for its project requirements such as structural, thermal, acoustic and fire behaviour.

The production of the Joris Ide decks are spread over two major production sites. Each site has the ability to perforate its own coils and has an intense stock of raw materials to supply your project with a fast lead time and great service. One site is located in Zwevezele, Belgium and one site is located in Ansbach, Germany.

JI decks

Production site Zwevezele, Belgium

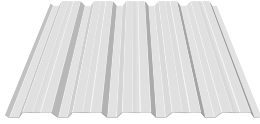

JI 35-207-1035 R



JI 37-265-1060



JI 42-252-1010



JI 56-225-900



JI 73-195-780

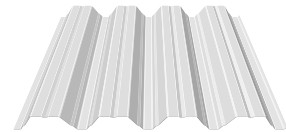

JI 85-280-1120

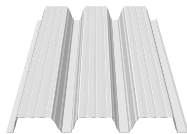

JI 106-250-750

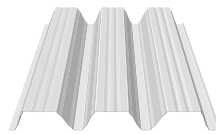

JI 113-320-960

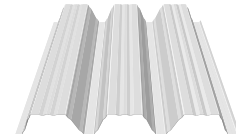

JI 137-310-930

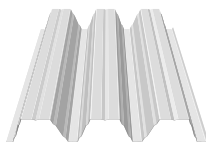

JI 153-280-840

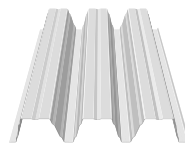

JI 158-250-750

Materials

The decks are available in the following materials:

- Galvanized steel
- 15 μ Polyester R912 steel
- 25 μ Polyester standard colour
- Prepainted aluminium
- Colorcoat HPS 200 Ultra® (prefinished steel)

JID decks

Production site Ansbach, Germany

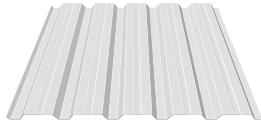

JID 35-207-1035

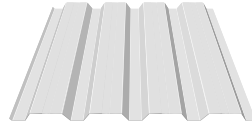

JID 50-250-1000

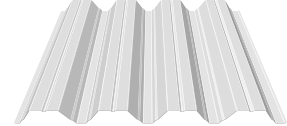

JID 85-280-1120

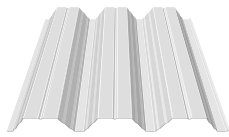

JID 89-305-915

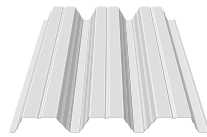

JID 100-275-825

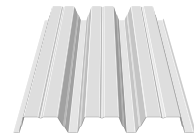

JID 106-250-750

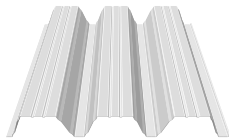

JID 137-310-930

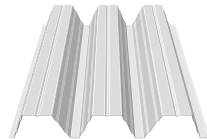

JID 153-280-840

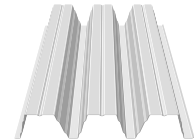

JID 158-250-750

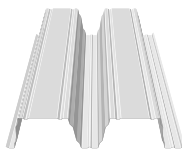

JID 200-375-750

Membrane Roof System

Membrane Roof Systems with structural decks are often used for very low pitched or flat roofs combining long spans.

The classic built-up exists out of JI Structural Deck ① in steel or aluminium with the option for perforation to improve acoustic absorption. Essential for this warm roof construction a vapour barrier ② is applied between the PIR, mineral wool or glass fibre insulation ③ to be finished with a waterproof membrane ④.

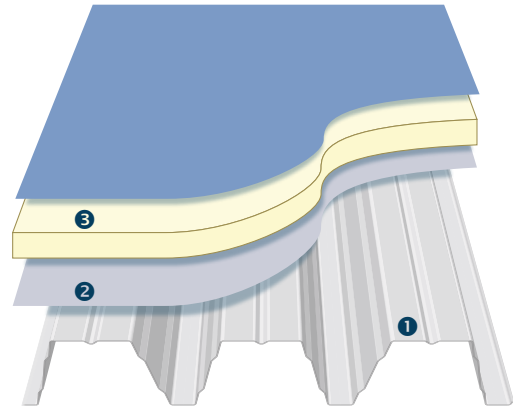

Standing Seam System

Standing Seam Systems are used for the combination of their secret fixation, ability for low pitched roofs and curved roofs.

The built up stands with a JI Structural Deck ① on which vapour barrier ② is placed between the deck and the bar and bracket system ③ & ④. The system is chosen and placed in function of the thickness of the insulation ⑤ and the useful width and model of the Standing Seam Profile ⑥.

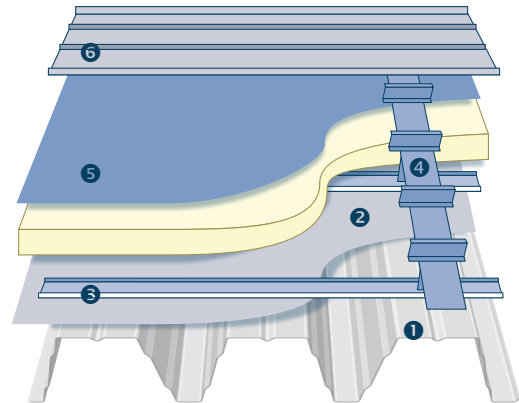

Green Roofs

Other applications such as green roofs are perfect to be designed using Joris Ide Structural Decks. A 200 Deck is one of the sole decks to perform under these elevated loads.

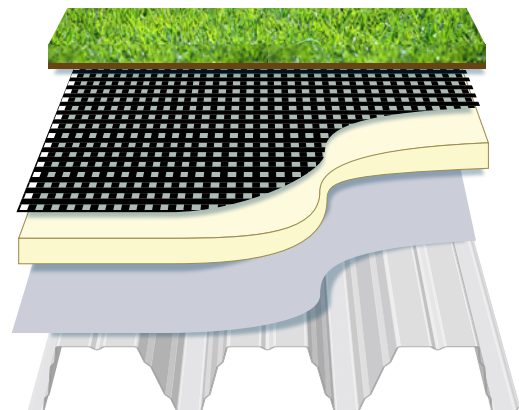

Perforation patterns

Perforation in the decks are available depending on the type of deck and the location of the perforation (web, pan or full) to improve the acoustic absorption performance of the built-up system. Each Joris Ide decking production site has a high-performance perforating line to offer what is required for the project.

Joris Ide Belgium offers the following perforation patterns:

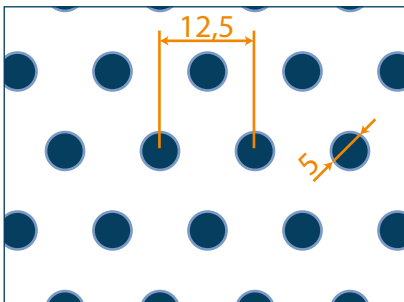

R5T12,5, 15% perforation (standard)

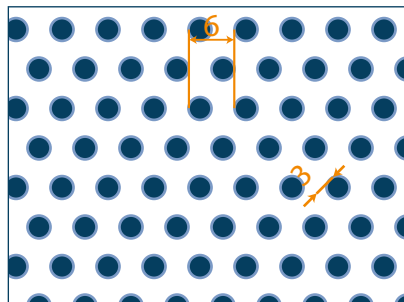

R3T6, 23% perforation (on demand)

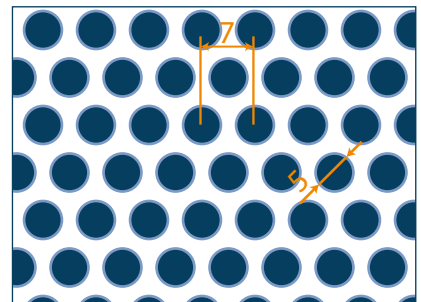

R5T7, 45% perforation (on demand)

Joris Ide Deutschland offers the following perforation patterns:

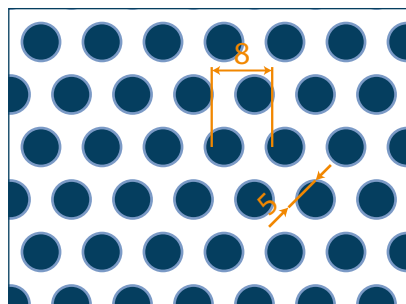

R5T8, 35% perforation (standard)

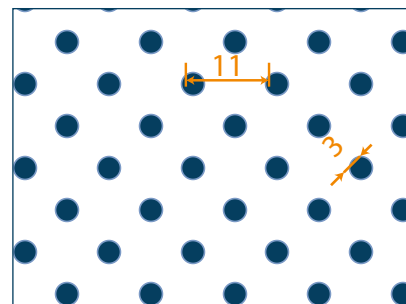

R3T11, 11,7% perforation (on demand)

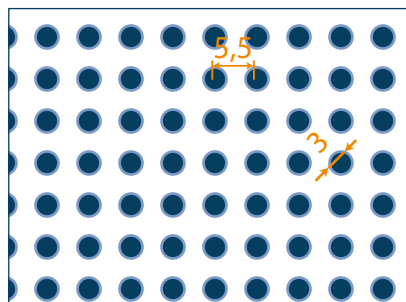

R3T5,5, 23,4% perforation (on demand)

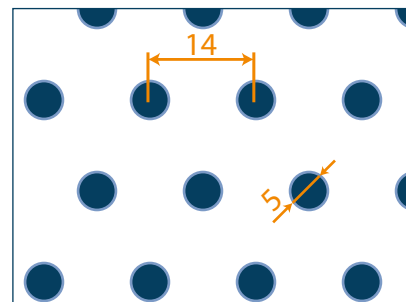

R5T14, 11,7% perforation (on demand)

Mounting instructions

Storage and handling

The packs need to be unloaded at site in a controlled and careful way not to damage the goods and according to the health and safety regulations at force.

Once unloaded, the packs need to be safely stored inside a cool and dry building and under a small slope in order to have no storage stain (white rust).



Fixing recommendations

The table below gives an overview of the recommended fixations.

These recommendations are based upon good practice and do not take away the responsibility of the designer and the installer to check the limits of the fasteners.

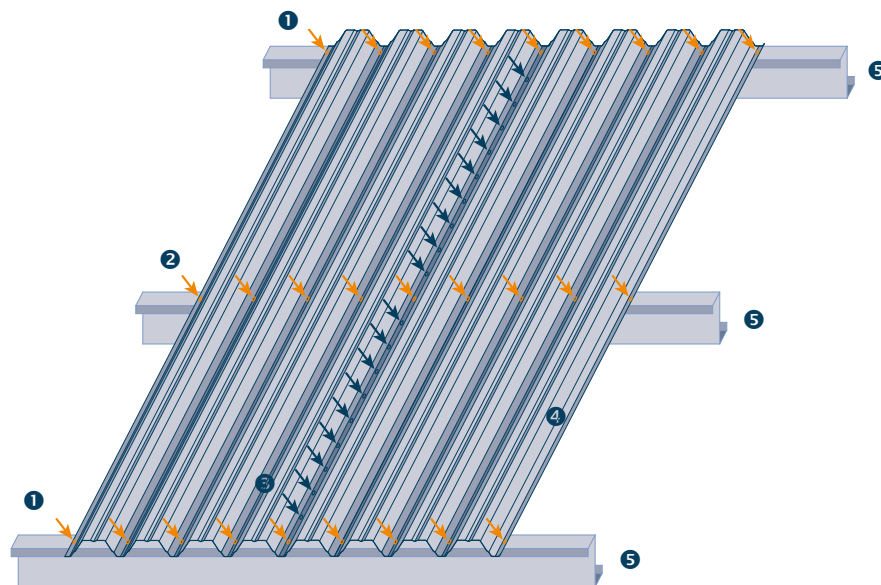
Main fixing at ridge and eaves	Main fixing intermediate	Side lap fixing
Every pitch	Every pitch	450 mm centres



1. Main fixing of ridges & eaves ()
2. Main fixing intermediate ()
3. Side lap fixing ()
4. Joris Ide metal deck ()
5. Purlin ()

Span

Because certain roofs are too long to span without additional support, people will add one, two, or more supports. Therefore the load span tables foresee three conditions:

Single span	Double span	Multiple span
		
The deck is only supported at the beginning and the end.	The deck is supported at the beginning, the end and only one place in the middle.	The deck is supported at the beginning, the end and on more than two places in the middle dividing it in equal distances

Diaphragm

What is a diaphragm action?

The roof sheeting in a rectangular building under horizontal loads behaves like the web of a deep plate girder spanning between vertical planes of support. In this plate girder the longitudinal edge members behave as flanges, carrying the axial tension and compression. The girder helps resist horizontal loads. In a pitched roof building the roof slopes help to resist both horizontal and vertical loads.

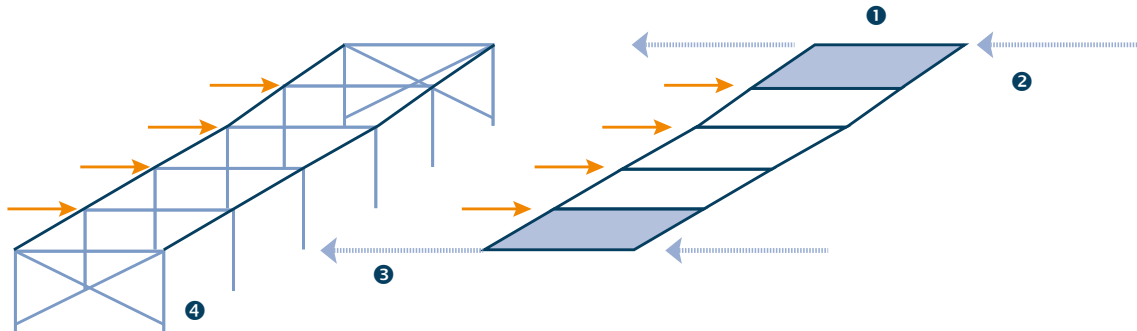

1. Shear field in sheeting
2. Flange forces in edge members
3. Sheeting
4. Roof sheeting acts as a deep plate girder carrying load back to stiffened gables

A shear panel may include some or all of the following components:

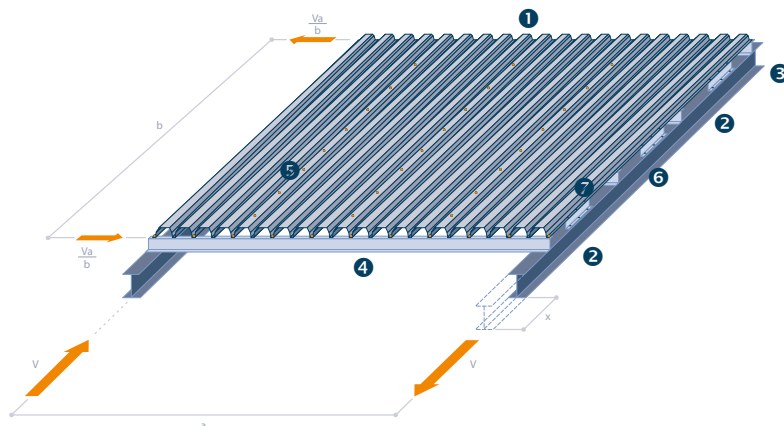

1. Individual lengths of profiled sheet
2. Perpendicular member (purlin)
3. Parallel member (rafter)
4. Sheet/perpendicular member fasteners
5. Seam fasteners
6. Shear connector
7. Sheet/parallel member fasteners

The way to calculate:

- Design the sheeting (and supporting members) for its primary purpose as cladding.
- Determine the in-plane loads on the sheeting and the shear force and maximum bending moment in the deep plate girder.
- Calculate the shear flexibility and the ultimate shear strength (based on the fasteners) of a shear panel.
- Check that:
 - The combined stresses in the supporting members are acceptable,
 - The ultimate shear strength of a shear panel is adequate,
 - The in-plane deflection of the diaphragm is acceptable.

Extended end laps

When decks of long length impact the cost of transportation or create an inefficiency for handling or installing on-site, the solution of extended overlaps can be applied.

Extended overlaps between two single span decks create a double span condition which enhances the mechanical performance. Therefore the below conditions need to be respected:

- Extended overlaps can only be used for decks manufactured out of steel. For perforated variances and aluminium decks please consult the Joris Ide Technical Support Team.
- The end lap must extend by 10% of the span from the opposite deck starting from the middle of the mutual purlin. So $A = 10\%$ of the single span that deck 2 performs and $B = 10\%$ of the single span that deck 1 performs
- The end laps need to be stitched in the web at the end of each overlap by preferably 5.50 mm diameter self-drilling steel stitching screws
- The deck is fixed according to the mounting instructions (see page 6)
- All fixings need to be checked and determined by calculation

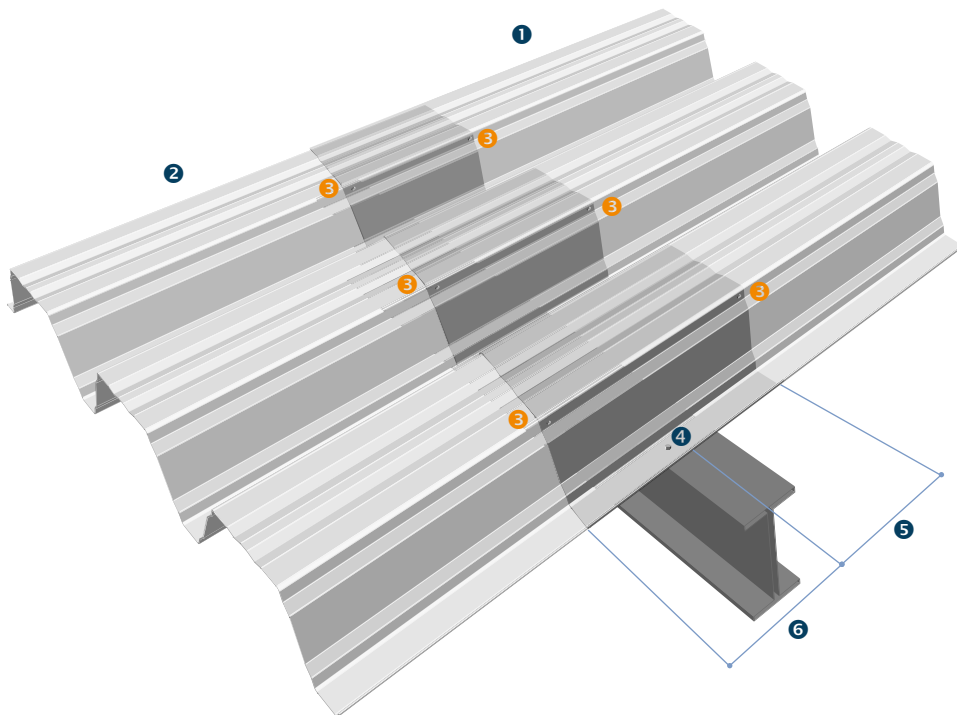

1. Deck 1
2. Deck 2
3. Stitch decks in the web at the end of each overlap
4. Fixing to the support
5. 10 % of single span deck 2
6. 10 % of single span deck 1

Designer's guide to structural decking

Production site:

Joris Ide Zwevezele, Belgium

JI 35-207-1035 R

JI

Application:	Structural metal roof deck	Finishing:	Interior liner and Galvanised
Yield Stress (MPa):	320	Intermediate Support width:	≥60 mm
Ym:	1	End Support width:	≥40 mm

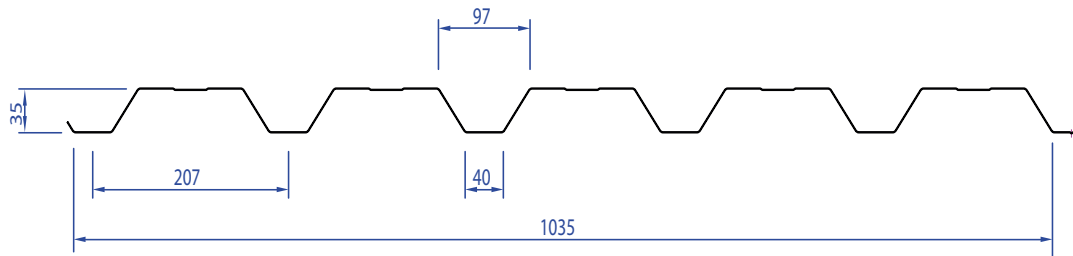

Mechanical Properties

tN [mm]	Weight (kg/m ²)	Broad flange in compression						Narrow flange in compression				
		Mc,Rk,F [kNm/m]	Mc,Rk,B [kNm/m]	Ieff [cm ⁴ /m]	Vw,Rk [kN/m]	Rw,Rk,B [kN/m]	Rw,Rk,A [kN/m]	Mc,Rk,F [kNm/m]	Mc,Rk,B [kNm/m]	Ieff [cm ⁴ /m]	Vw,Rk [kN/m]	Rw,Rk,A [kN/m]
0,75	6,94	1,85	1,95	11,79	55,39	22,36	9,70	1,95	1,85	15,82	55,39	55,39
0,88	8,14	2,39	2,45	14,69	67,38	30,21	13,15	2,45	2,39	19,66	67,38	67,38
1,00	9,25	2,92	2,94	17,50	76,99	38,34	16,74	2,94	2,92	22,47	76,99	76,99
1,25	11,57	4,06	4,00	23,68	97,02	57,89	25,41	4,00	4,06	28,31	97,02	97,02

Load type (kN/m²)

Thickness (mm)			Span (m)														
			1,20	1,40	1,60	1,80	2,00	2,20	2,40	2,60	2,80	3,00	3,20	3,40	3,60	3,80	4,00
0,75	Pressure	Single	5,50	3,46	2,32	1,63	1,19										
		Double	6,87	5,04	3,86	3,05	2,47	2,04	1,66	1,30							
		Multiple	6,87	5,24	4,21	3,08	2,25	1,69	1,30								
	Suction	Single	7,21	5,30	4,06	2,92	2,13										
		Double	6,87	5,04	3,86	3,05	2,47	2,04	1,72	1,46							
		Multiple	8,58	6,31	4,83	3,81	3,09	2,55	2,15								
0,88	Pressure	Single	6,86	4,32	2,89	2,03	1,48	1,11									
		Double	8,86	6,51	4,99	3,94	3,19	2,64	2,06	1,62	1,30						
		Multiple	8,86	6,80	5,45	3,84	2,80	2,10	1,62	1,28							
	Suction	Single	9,09	6,68	5,11	3,62	2,64	1,99									
		Double	8,86	6,51	4,99	3,94	3,19	2,64	2,22	1,89	1,63						
		Multiple	11,08	8,14	6,23	4,92	3,99	3,30	2,77	2,27							
1,00	Pressure	Single	8,17	5,14	3,45	2,42	1,76	1,33									
		Double	10,81	7,94	6,08	4,80	3,89	3,19	2,46	1,93	1,55	1,26					
		Multiple	10,81	8,35	6,52	4,58	3,34	2,51	1,93	1,52	1,22						
	Suction	Single	10,90	8,01	5,90	4,14	3,02	2,27									
		Double	10,81	7,94	6,08	4,80	3,89	3,21	2,70	2,30	1,98	1,73					
		Multiple	13,51	9,92	7,60	6,00	4,86	4,02	3,31	2,60	2,08						
1,25	Pressure	Single	11,05	6,96	4,66	3,27	2,39	1,79	1,38								
		Double	15,04	11,05	8,46	6,68	5,41	4,32	3,33	2,62	2,10	1,70	1,40	1,17			
		Multiple	15,31	11,83	8,82	6,19	4,51	3,39	2,61	2,05	1,65	1,34	1,10				
	Suction	Single	14,83	10,90	7,43	5,22	3,80	2,86	2,20								
		Double	15,04	11,05	8,46	6,68	5,41	4,47	3,76	3,20	2,76	2,41	2,11	1,87			
		Multiple	18,80	13,81	10,57	8,35	6,77	5,41	4,16	3,28	2,62	2,13	1,76				

pressure load - deflection limit L/200
suction load - deflection limit L/150
the load shown is the ultimate load divided by 1,5

APPLIED STANDARDS / NOTES

Tolerances/Coatings	EN 10143	Steel Quality	EN 10346	Handling	European Recommendations
Tests/Calculations	EN 1990, EN 1991 1-6, EN 1993 1-3, EN 1993 1-5 (Calculations are to Eurocode, however additional checks such as fixings are required)				
Deck self weight has not been allowed for, so has to be included in applied loads					

JI 35-207-1035 R Perfo Flange (R5T12.5-P)

JI

Application:	Structural metal roof deck	Finishing:	Interior liner and Galvanised
Yield Stress (MPa):	320	Intermediate Support width:	≥60 mm
Ym:	1	End Support width:	≥40 mm

■ = perforated zone

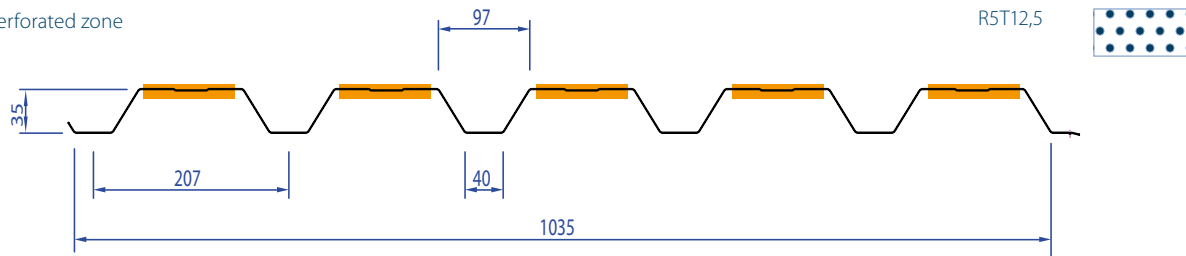

Mechanical Properties

tN [mm]	Weight (kg/m ²)	Broad flange in compression						Narrow flange in compression				
		Mc,Rk,F [kNm/m]	Mc,Rk,B [kNm/m]	leff [cm ² /m]	Vw,Rk [kN/m]	Rw,Rk,B [kN/m]	Rw,Rk,A [kN/m]	Mc,Rk,F [kNm/m]	Mc,Rk,B [kNm/m]	leff [cm ² /m]	Vw,Rk [kN/m]	Rw,Rk,A [kN/m]
0,75	6,94	1,54	1,89	10,30	55,39	22,36	9,70	1,89	1,54	14,34	55,39	55,39
0,88	8,14	1,96	2,38	12,77	67,38	30,21	13,15	2,38	1,96	17,78	67,38	67,38
1,00	9,25	2,37	2,86	15,17	76,99	38,34	16,74	2,86	2,37	20,32	76,99	76,99
1,25	11,57	3,33	3,89	20,45	97,02	57,89	25,41	3,89	3,33	25,61	97,02	97,02

Load type (kN/m²)

Thickness (mm)			Span (m)														
			1,20	1,40	1,60	1,80	2,00	2,20	2,40	2,60	2,80	3,00	3,20	3,40	3,60	3,80	4,00
0,75	Pressure	Single	4,81	3,03	2,03	1,42											
		Double	5,71	4,29	3,43	2,80	2,33	1,88	1,45	1,14							
		Multiple	6,61	5,15	3,84	2,69	1,96	1,48	1,14								
	Suction	Single	7,00	5,14	3,76	2,64											
		Double	5,71	4,19	3,21	2,54	2,05	1,70	1,43	1,22							
		Multiple	7,13	5,24	4,01	3,17	2,57	2,12	1,78								
0,88	Pressure	Single	5,96	3,75	2,51	1,77	1,29										
		Double	7,24	5,56	4,43	3,61	3,01	2,33	1,80	1,41	1,13						
		Multiple	8,61	6,69	4,76	3,34	2,44	1,83	1,41	1,11							
	Suction	Single	8,82	6,48	4,67	3,28	2,39										
		Double	7,24	5,32	4,08	3,22	2,61	2,16	1,81	1,54	1,33						
		Multiple	9,06	6,65	5,09	4,02	3,26	2,69	2,26	1,93							
1,00	Pressure	Single	7,08	4,46	2,99	2,10	1,53	1,15									
		Double	8,83	6,81	5,42	4,42	3,67	2,77	2,13	1,68	1,34						
		Multiple	10,59	8,21	5,65	3,97	2,89	2,17	1,67	1,32							
	Suction	Single	10,59	7,78	5,33	3,75	2,73	2,05									
		Double	8,78	6,45	4,94	3,90	3,16	2,61	2,20	1,87	1,61						
		Multiple	10,98	8,07	6,18	4,88	3,95	3,27	2,75	2,34							
1,25	Pressure	Single	9,55	6,01	4,03	2,83	2,06	1,55	1,19								
		Double	12,53	9,63	7,63	6,20	4,97	3,73	2,87	2,26	1,81	1,47	1,21				
		Multiple	15,07	11,37	7,62	5,35	3,90	2,93	2,26	1,78	1,42	1,16					
	Suction	Single	14,41	10,03	6,72	4,72	3,44	2,59	1,99								
		Double	12,34	9,07	6,94	5,48	4,44	3,67	3,08	2,63	2,27	1,97	1,74				
		Multiple	15,42	11,33	8,68	6,85	5,55	4,59	3,77	2,96	2,37	1,93					

pressure load - deflection limit L/200
suction load - deflection limit L/150
the load shown is the ultimate load divided by 1,5

APPLIED STANDARDS / NOTES

Tolerances/Coatings	EN 10143	Steel Quality	EN 10346	Handling	European Recommendations
Tests/Calculations	EN 1990, EN 1991 1-6, EN 1993 1-3, EN 1993 1-5 (Calculations are to Eurocode, however additional checks such as fixings are required)				
	Deck self weight has not been allowed for, so has to be included in applied loads				

JI 37-265-1060

JI

Application:	Structural metal roof deck	Finishing:	Interior liner and Galvanised
Yield Stress (MPa):	320	Intermediate Support width:	≥60 mm
Ym:	1	End Support width:	≥40 mm

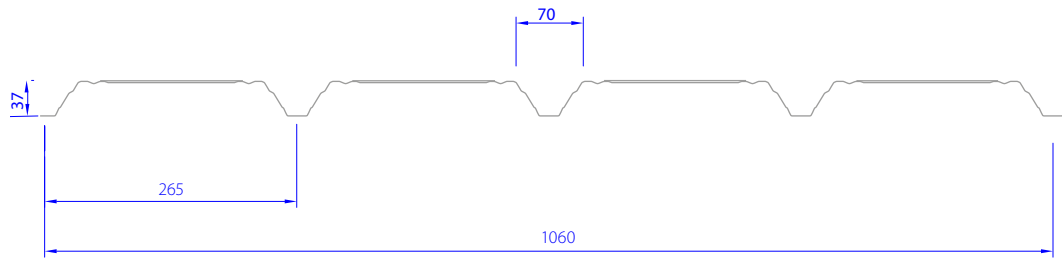

Mechanical Properties

tN [mm]	Weight (kg/m ²)	Broad flange in compression						Narrow flange in compression				
		Mc,Rk,F [kNm/m]	Mc,Rk,B [kNm/m]	I _{eff} [cm ⁴ /m]	Vw,Rk [kN/m]	Rw,Rk,B [kN/m]	Rw,Rk,A [kN/m]	Mc,Rk,F [kNm/m]	Mc,Rk,B [kNm/m]	I _{eff} [cm ⁴ /m]	Vw,Rk [kN/m]	Rw,Rk,A [kN/m]
0,75	6,95	1,58	1,42	12,07	43,75	23,60	10,23	1,42	1,58	12,91	43,75	43,75
0,88	8,15	1,96	1,68	14,31	51,75	32,37	14,09	1,68	1,96	15,27	51,75	51,75
1,00	9,27	2,33	1,92	16,38	59,13	41,50	18,12	1,92	2,33	17,44	59,13	59,13
1,25	11,58	3,13	2,42	20,74	74,50	63,61	27,92	2,42	3,13	21,97	74,50	74,50

Load type (kN/m²)

Thickness (mm)			Span (m)														
			1,00	1,20	1,40	1,60	1,80	2,00	2,20	2,40	2,60	2,80	3,00	3,20	3,40	3,60	3,80
0,75	Pressure	Single	8,43	5,63	3,55	2,38	1,67	1,22									
		Double	8,43	5,86	4,30	3,29	2,60	2,11	1,74	1,46	1,25						
		Multiple	8,43	5,86	4,42	3,50	2,84	2,30	1,73	1,33							
	Suction	Single	7,59	5,27	3,87	2,96	2,34	1,73									
		Double	8,43	5,86	4,30	3,29	2,60	2,11	1,74	1,46	1,25						
		Multiple	10,54	7,32	5,38	4,12	3,25	2,64	2,18	1,83							
0,88	Pressure	Single	10,43	6,68	4,21	2,82	1,98	1,44									
		Double	10,43	7,24	5,32	4,07	3,22	2,61	2,15	1,81	1,54	1,27					
		Multiple	10,43	7,24	5,49	4,33	3,46	2,73	2,05	1,58	1,24						
	Suction	Single	8,97	6,23	4,58	3,51	2,77	2,05									
		Double	10,43	7,24	5,32	4,07	3,22	2,61	2,15	1,81	1,54	1,33					
		Multiple	13,04	9,05	6,65	5,09	4,02	3,26	2,69	2,25	1,77						
1,00	Pressure	Single	12,45	7,64	4,81	3,22	2,26	1,65									
		Double	12,45	8,65	6,35	4,86	3,84	3,11	2,57	2,16	1,81	1,45					
		Multiple	12,45	8,65	6,49	5,01	3,96	3,12	2,35	1,81	1,42						
	Suction	Single	10,25	7,12	5,23	4,01	3,16	2,34									
		Double	12,45	8,65	6,35	4,86	3,84	3,11	2,57	2,16	1,84	1,59					
		Multiple	15,56	10,81	7,94	6,08	4,80	3,89	3,22	2,57	2,02						
1,25	Pressure	Single	16,70	9,68	6,10	4,08	2,87	2,09	1,57	1,21							
		Double	16,70	11,59	8,52	6,52	5,15	4,17	3,45	2,90	2,29	1,84	1,49	1,23			
		Multiple	16,70	11,59	8,52	6,52	5,15	3,95	2,97	2,29	1,80	1,44	1,17				
	Suction	Single	12,91	8,97	6,59	5,04	3,99	2,95	2,22	1,71							
		Double	16,70	11,59	8,52	6,52	5,15	4,17	3,45	2,90	2,47	2,13	1,86	1,63			
		Multiple	20,18	14,01	10,30	7,88	6,23	5,04	4,17	3,23	2,54	2,04	1,65				

pressure load - deflection limit L/200
suction load - deflection limit L/150
the load shown is the ultimate load divided by 1,5

APPLIED STANDARDS / NOTES

Tolerances/Coatings	EN 10143	Steel Quality	EN 10346	Handling	European Recommendations
Tests/Calculations	EN 1990, EN 1991 1-6, EN 1993 1-3, EN 1993 1-5 (Calculations are to Eurocode, however additional checks such as fixings are required)				
Deck self weight has not been allowed for, so has to be included in applied loads					

JI 42-252-1010

JI

Application:	Structural metal roof deck	Finishing:	Interior liner and Galvanised
Yield Stress (MPa):	320	Intermediate Support width:	≥60 mm
Ym:	1	End Support width:	≥40 mm

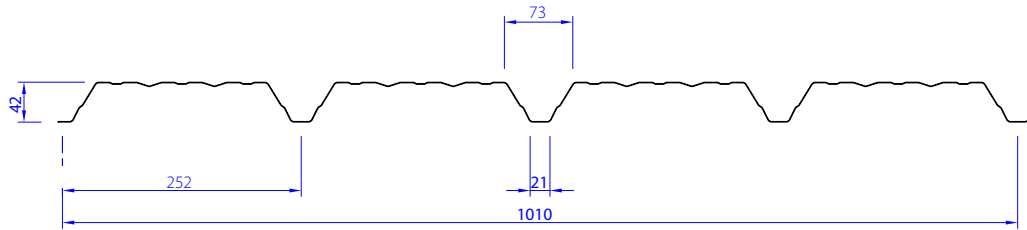

Mechanical Properties

tN [mm]	Weight (kg/m ²)	Broad flange in compression						Narrow flange in compression				
		Mc,Rk,F [kNm/m]	Mc,Rk,B [kNm/m]	I _{eff} [cm ⁴ /m]	Vw,Rk [kN/m]	Rw,Rk,B [kN/m]	Rw,Rk,A [kN/m]	Mc,Rk,F [kNm/m]	Mc,Rk,B [kNm/m]	I _{eff} [cm ⁴ /m]	Vw,Rk [kN/m]	Rw,Rk,A [kN/m]
0,75	7,11	2,21	1,76	17,40	50,68	18,23	7,91	1,76	2,21	17,56	50,68	50,68
0,88	8,34	2,72	2,08	20,71	59,94	24,73	10,76	2,08	2,72	20,77	59,94	59,94
1,00	9,48	3,20	2,38	23,72	68,49	31,50	13,75	2,38	3,20	23,72	68,49	68,49
1,25	11,85	4,20	2,99	29,88	86,29	48,02	21,08	2,99	4,20	29,88	86,29	86,29

Load type (kN/m²)

Thickness (mm)			Span (m)														
			1,00	1,20	1,40	1,60	1,80	2,00	2,20	2,40	2,60	2,80	3,00	3,20	3,40	3,60	3,80
0,75	Pressure	Single	10,55	8,12	5,11	3,43	2,41	1,75	1,32								
		Double	8,71	6,54	5,10	4,09	3,36	2,81	2,39	2,05	1,74	1,50	1,25				
		Multiple	10,33	7,80	6,02	4,61	3,64	2,95	2,44	1,92	1,51	1,21					
	Suction	Single	9,38	6,52	4,79	3,67	2,90	2,35	1,77								
		Double	11,79	8,19	6,02	4,61	3,64	2,95	2,44	2,05	1,74	1,50	1,31				
		Multiple	14,66	10,18	7,48	5,73	4,53	3,67	3,03	2,55	2,03	1,63					
0,88	Pressure	Single	14,35	9,66	6,09	4,08	2,86	2,09	1,57	1,21							
		Double	11,05	8,24	6,39	5,10	4,17	3,48	2,94	2,52	2,15	1,83	1,49	1,23			
		Multiple	13,15	9,85	7,41	5,68	4,48	3,63	2,97	2,29	1,80	1,44	1,17				
	Suction	Single	11,10	7,71	5,66	4,33	3,42	2,77	2,10	1,62							
		Double	14,53	10,09	7,41	5,68	4,48	3,63	3,00	2,52	2,15	1,85	1,61	1,42			
		Multiple	17,34	12,04	8,85	6,77	5,35	4,33	3,58	3,01	2,40	1,92	1,56				
1,00	Pressure	Single	17,08	11,07	6,97	4,67	3,28	2,39	1,80	1,38							
		Double	13,30	9,86	7,61	6,06	4,94	4,10	3,47	2,97	2,53	2,10	1,71	1,41	1,17		
		Multiple	15,87	11,83	8,72	6,67	5,27	4,27	3,40	2,62	2,06	1,65	1,34	1,10			
	Suction	Single	12,68	8,80	6,47	4,95	3,91	3,17	2,40	1,85							
		Double	17,08	11,86	8,72	6,67	5,27	4,27	3,53	2,97	2,53	2,18	1,90	1,67	1,48		
		Multiple	19,81	13,76	10,11	7,74	6,11	4,95	4,09	3,44	2,75	2,20	1,79	1,47			
1,25	Pressure	Single	22,39	13,94	8,78	5,88	4,13	3,01	2,26	1,74	1,37	1,10					
		Double	18,24	13,39	10,26	8,11	6,58	5,44	4,58	3,89	3,30	2,64	2,15	1,77	1,48	1,24	
		Multiple	21,86	15,55	11,42	8,74	6,91	5,60	4,28	3,30	2,59	2,08	1,69	1,39	1,16		
	Suction	Single	15,97	11,09	8,15	6,24	4,93	3,99	3,02	2,32	1,83	1,46					
		Double	22,39	15,55	11,42	8,74	6,91	5,60	4,63	3,89	3,31	2,86	2,49	2,19	1,94	1,66	
		Multiple	24,95	17,32	12,73	9,74	7,70	6,24	5,15	4,33	3,46	2,77	2,25	1,85	1,55		

pressure load - deflection limit L/200
suction load - deflection limit L/150
the load shown is the ultimate load divided by 1,5

APPLIED STANDARDS / NOTES

Tolerances/Coatings	EN 10143	Steel Quality	EN 10346	Handling	European Recommendations
Tests/Calculations	EN 1990, EN 1991 1-6, EN 1993 1-3, EN 1993 1-5 (Calculations are to Eurocode, however additional checks such as fixings are required)				
Deck self weight has not been allowed for, so has to be included in applied loads					

JI 42-252-1010 Perfo Web (R5T12.5-O)

JI

Application:	Structural metal roof deck	Finishing:	Interior liner and Galvanised
Yield Stress (MPa):	320	Intermediate Support width:	≥60 mm
Ym:	1	End Support width:	≥40 mm

■ = perforated zone

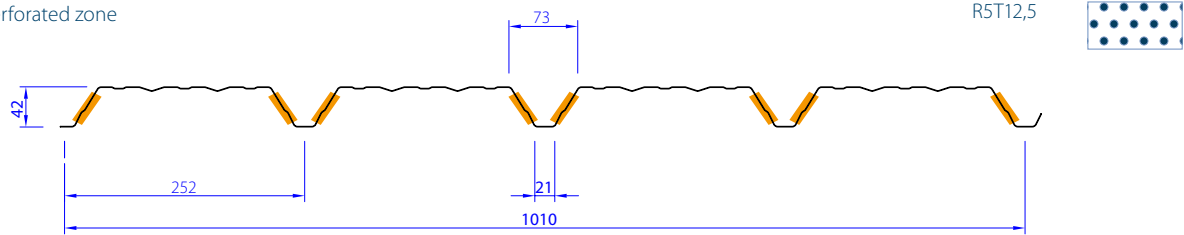

Mechanical Properties

tN [mm]	Weight (kg/m ²)	Broad flange in compression						Narrow flange in compression					
		Mc,Rk,F [kNm/m]	Mc,Rk,B [kNm/m]	Ieff [cm ⁴ /m]	Vw,Rk [kN/m]	Rw,Rk,B [kN/m]	Rw,Rk,A [kN/m]	Mc,Rk,F [kNm/m]	Mc,Rk,B [kNm/m]	Ieff [cm ⁴ /m]	Vw,Rk [kN/m]	Rw,Rk,A [kN/m]	
0,75	7,11	2,01	1,56	15,60	38,22	13,43	5,80	1,56	2,01	16,07	38,22	38,22	
0,88	8,34	2,45	1,85	18,89	50,28	18,23	7,91	1,85	2,45	19,01	50,28	50,28	
1,00	9,48	2,85	2,12	21,79	57,45	23,25	10,11	2,12	2,85	21,72	57,45	57,45	
1,25	11,85	3,68	2,67	27,46	72,37	35,46	15,51	2,67	3,68	27,38	72,37	72,37	

Load type (kN/m²)

Thickness (mm)			Span (m)														
			1,00	1,20	1,40	1,60	1,80	2,00	2,20	2,40	2,60	2,80	3,00	3,20	3,40	3,60	3,80
0,75	Pressure	Single	7,74	6,45	4,59	3,07	2,16	1,57	1,18								
		Double	6,97	5,29	4,16	3,36	2,78	2,33	1,99	1,72	1,50	1,32	1,12				
		Multiple	7,74	6,28	4,96	4,02	3,31	2,68	2,22	1,72	1,35						
	Suction	Single	8,34	5,80	4,26	3,26	2,58	2,09	1,62								
		Double	10,72	7,45	5,47	4,19	3,31	2,68	2,22	1,86	1,59	1,37	1,19				
		Multiple	13,04	9,05	6,65	5,09	4,02	3,26	2,69	2,26	1,86						
0,88	Pressure	Single	10,54	8,79	5,55	3,72	2,61	1,90	1,43	1,10							
		Double	8,91	6,71	5,25	4,22	3,47	2,91	2,47	2,12	1,85	1,62	1,36	1,12			
		Multiple	10,54	8,00	6,28	5,07	4,04	3,27	2,70	2,08	1,64	1,31					
	Suction	Single	9,87	6,86	5,04	3,86	3,05	2,47	1,92	1,48							
		Double	13,07	9,08	6,67	5,11	4,04	3,27	2,70	2,27	1,93	1,67	1,45	1,28			
		Multiple	15,43	10,71	7,87	6,03	4,76	3,86	3,19	2,68	2,20	1,76					
1,00	Pressure	Single	13,48	10,17	6,40	4,29	3,01	2,20	1,65	1,27							
		Double	10,80	8,08	6,29	5,04	4,13	3,45	2,92	2,51	2,18	1,91	1,57	1,29			
		Multiple	12,83	9,65	7,54	5,95	4,70	3,81	3,12	2,40	1,89	1,51	1,23				
	Suction	Single	11,28	7,83	5,76	4,41	3,48	2,82	2,19	1,69							
		Double	15,22	10,57	7,77	5,95	4,70	3,81	3,14	2,64	2,25	1,94	1,69	1,49			
		Multiple	17,63	12,24	8,99	6,89	5,44	4,41	3,64	3,06	2,51	2,01	1,64				
1,25	Pressure	Single	19,61	12,82	8,07	5,41	3,80	2,77	2,08	1,60	1,26						
		Double	14,95	11,08	8,55	6,80	5,55	4,61	3,89	3,33	2,88	2,43	1,98	1,63	1,36	1,14	
		Multiple	17,84	13,29	10,00	7,66	6,05	4,90	3,93	3,03	2,38	1,91	1,55	1,28			
	Suction	Single	14,22	9,87	7,25	5,55	4,39	3,55	2,76	2,13	1,67						
		Double	19,61	13,62	10,00	7,66	6,05	4,90	4,05	3,40	2,90	2,50	2,18	1,91	1,70	1,51	
		Multiple	22,21	15,43	11,33	8,68	6,86	5,55	4,59	3,86	3,17	2,54	2,06	1,70			

pressure load - deflection limit L/200
suction load - deflection limit L/150
the load shown is the ultimate load divided by 1,5

APPLIED STANDARDS / NOTES

Tolerances/Coatings	EN 10143	Steel Quality	EN 10346	Handling	European Recommendations
Tests/Calculations	EN 1990, EN 1991 1-6, EN 1993 1-3, EN 1993 1-5 (Calculations are to Eurocode, however additional checks such as fixings are required)				
Deck self weight has not been allowed for, so has to be included in applied loads					

JI 42-252-1010 Perfo Full (R5T12.5-F)

JI

Application:	Structural metal roof deck	Finishing:	Interior liner and Galvanised
Yield Stress (MPa):	320	Intermediate Support width:	≥60 mm
Ym:	1	End Support width:	≥40 mm

■ = perforated zone

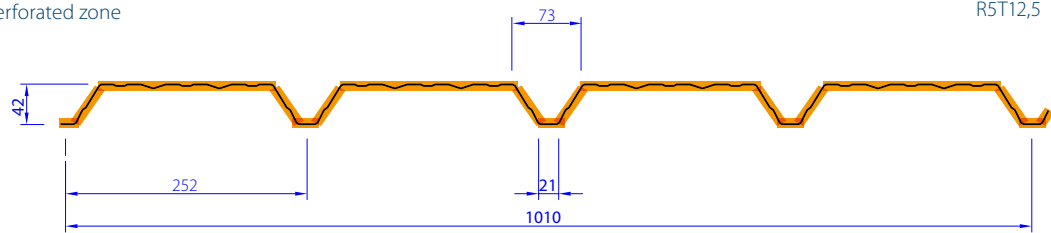

Mechanical Properties

tN [mm]	Weight (kg/m ²)	Broad flange in compression						Narrow flange in compression					
		Mc,Rk,F [kNm/m]	Mc,Rk,B [kNm/m]	Ieff [cm ⁴ /m]	Vw,Rk [kN/m]	Rw,Rk,B [kN/m]	Rw,Rk,A [kN/m]	Mc,Rk,F [kNm/m]	Mc,Rk,B [kNm/m]	Ieff [cm ⁴ /m]	Vw,Rk [kN/m]	Rw,Rk,A [kN/m]	
0,75	7,11	1,71	1,34	13,09	38,22	13,43	5,80	1,34	1,71	13,37	38,22	38,22	
0,88	8,34	2,11	1,58	15,88	50,28	18,23	7,91	1,58	2,11	15,82	50,28	50,28	
1,00	9,48	2,48	1,81	18,34	57,45	23,25	10,11	1,81	2,48	18,09	57,45	57,45	
1,25	11,85	3,25	2,28	23,14	72,37	35,46	15,51	2,28	3,25	22,82	72,37	72,37	

Load type (kN/m²)

Thickness (mm)			Span (m)														
			1,00	1,20	1,40	1,60	1,80	2,00	2,20	2,40	2,60	2,80	3,00	3,20	3,40	3,60	3,80
0,75	Pressure	Single	7,74	6,11	3,85	2,58	1,81	1,32									
		Double	6,51	4,89	3,82	3,07	2,52	2,11	1,79	1,54	1,34	1,16					
		Multiple	7,71	5,83	4,57	3,57	2,82	2,28	1,88	1,44	1,14						
	Suction	Single	7,13	4,95	3,64	2,78	2,20	1,78									
		Double	9,13	6,34	4,66	3,57	2,82	2,28	1,89	1,59	1,35	1,16					
		Multiple	11,14	7,73	5,68	4,35	3,44	2,78	2,30	1,93	1,55						
0,88	Pressure	Single	10,54	7,41	4,67	3,13	2,20	1,60	1,20								
		Double	8,27	6,18	4,80	3,84	3,14	2,62	2,22	1,90	1,65	1,41	1,14				
		Multiple	9,84	7,39	5,74	4,39	3,47	2,81	2,28	1,75	1,38	1,10					
	Suction	Single	8,44	5,86	4,30	3,30	2,60	2,11	1,60								
		Double	11,24	7,81	5,74	4,39	3,47	2,81	2,32	1,95	1,66	1,43	1,25				
		Multiple	13,18	9,16	6,73	5,15	4,07	3,30	2,72	2,29	1,83	1,47					
1,00	Pressure	Single	13,22	8,56	5,39	3,61	2,54	1,85	1,39								
		Double	9,98	7,41	5,73	4,56	3,72	3,10	2,62	2,24	1,94	1,62	1,32				
		Multiple	11,90	8,88	6,74	5,16	4,08	3,30	2,63	2,02	1,59	1,27					
	Suction	Single	9,65	6,70	4,92	3,77	2,98	2,41	1,83								
		Double	13,22	9,18	6,74	5,16	4,08	3,30	2,73	2,30	1,96	1,69	1,47				
		Multiple	15,07	10,47	7,69	5,89	4,65	3,77	3,11	2,62	2,09	1,68					
1,25	Pressure	Single	17,35	10,80	6,80	4,56	3,20	2,33	1,75	1,35							
		Double	13,72	10,09	7,74	6,13	4,97	4,12	3,46	2,96	2,55	2,05	1,66	1,37	1,14		
		Multiple	16,43	12,05	8,85	6,78	5,35	4,34	3,31	2,55	2,01	1,61	1,31				
	Suction	Single	12,17	8,45	6,21	4,75	3,76	3,04	2,30	1,77							
		Double	17,35	12,05	8,85	6,78	5,35	4,34	3,58	3,01	2,57	2,21	1,93	1,69	1,50		
		Multiple	19,02	13,21	9,70	7,43	5,87	4,75	3,93	3,30	2,64	2,11	1,72				

pressure load - deflection limit L/200
suction load - deflection limit L/150
the load shown is the ultimate load divided by 1,5

APPLIED STANDARDS / NOTES

Tolerances/Coatings	EN 10143	Steel Quality	EN 10346	Handling	European Recommendations
Tests/Calculations	EN 1990, EN 1991 1-6, EN 1993 1-3, EN 1993 1-5 (Calculations are to Eurocode, however additional checks such as fixings are required)				
	Deck self weight has not been allowed for, so has to be included in applied loads				

JI 56-225-900

JI

Application:	Structural metal roof deck	Finishing:	Interior liner and Galvanised
Yield Stress (MPa):	320	Intermediate Support width:	≥60 mm
Ym:	1	End Support width:	≥40 mm

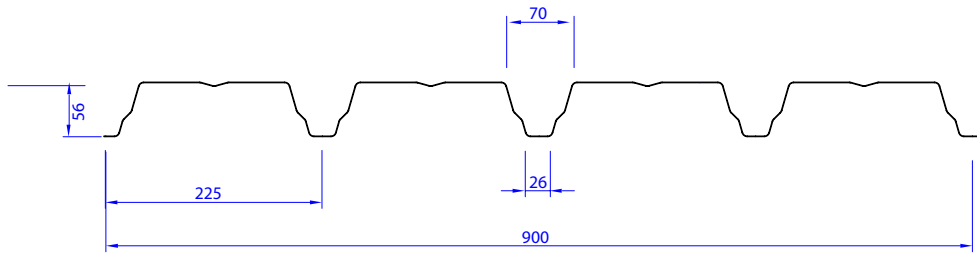

Mechanical Properties

tN [mm]	Weight (kg/m ²)	Broad flange in compression						Narrow flange in compression				
		Mc,Rk,F [kNm/m]	Mc,Rk,B [kNm/m]	I _{eff} [cm ⁴ /m]	Vw,Rk [kN/m]	Rw,Rk,B [kN/m]	Rw,Rk,A [kN/m]	Mc,Rk,F [kNm/m]	Mc,Rk,B [kNm/m]	I _{eff} [cm ⁴ /m]	Vw,Rk [kN/m]	Rw,Rk,A [kN/m]
0,75	8,02	3,46	3,14	37,80	67,25	26,87	11,66	3,14	3,46	39,04	67,25	67,25
0,88	9,41	4,35	3,72	45,06	82,28	37,48	16,32	3,72	4,35	46,16	82,28	82,28
1,00	10,69	5,19	4,24	51,87	94,01	48,59	21,21	4,24	5,19	52,73	94,01	94,01
1,25	13,37	7,01	5,34	66,27	118,42	75,63	33,19	5,34	7,01	66,40	118,42	118,42

Load type (kN/m²)

Thickness (mm)			Span (m)														
			1,80	2,00	2,20	2,40	2,60	2,80	3,00	3,20	3,40	3,60	3,80	4,00	4,20	4,40	4,60
0,75	Pressure	Single	5,23	3,81	2,86	2,20	1,73	1,39	1,13								
		Double	5,57	4,61	3,81	3,20	2,73	2,35	2,05	1,80	1,59	1,42	1,28	1,15			
		Multiple	5,69	4,61	3,81	3,20	2,73	2,37	2,11	1,76	1,47	1,24					
	Suction	Single	5,17	4,19	3,46	2,91	2,39	1,91	1,55								
		Double	5,69	4,61	3,81	3,20	2,73	2,35	2,05	1,80	1,59	1,42	1,28	1,15			
		Multiple	7,11	5,76	4,76	4,00	3,41	2,94	2,56	2,25	1,99	1,70					
0,88	Pressure	Single	6,23	4,54	3,41	2,63	2,07	1,66	1,35	1,11							
		Double	7,03	5,80	4,79	4,03	3,43	2,96	2,58	2,26	2,01	1,79	1,60	1,37	1,18		
		Multiple	7,16	5,80	4,79	4,03	3,43	2,96	2,55	2,10	1,75	1,47	1,25				
	Suction	Single	6,12	4,95	4,09	3,44	2,82	2,26	1,84	1,51							
		Double	7,16	5,80	4,79	4,03	3,43	2,96	2,58	2,26	2,01	1,79	1,61	1,45	1,31		
		Multiple	8,95	7,25	5,99	5,03	4,29	3,70	3,22	2,83	2,39	2,01	1,71				
1,00	Pressure	Single	7,17	5,23	3,93	3,03	2,38	1,91	1,55	1,28							
		Double	8,40	6,92	5,72	4,81	4,09	3,53	3,08	2,70	2,39	2,14	1,84	1,57	1,36	1,18	
		Multiple	8,54	6,92	5,72	4,81	4,09	3,53	2,93	2,41	2,01	1,70	1,44	1,24			
	Suction	Single	6,99	5,66	4,68	3,93	3,23	2,58	2,10	1,73							
		Double	8,54	6,92	5,72	4,81	4,09	3,53	3,08	2,70	2,39	2,14	1,92	1,73	1,57	1,43	
		Multiple	10,68	8,65	7,15	6,01	5,12	4,41	3,84	3,27	2,73	2,30	1,95	1,68			
1,25	Pressure	Single	9,16	6,68	5,02	3,87	3,04	2,43	1,98	1,63	1,36	1,15					
		Double	11,33	9,34	7,72	6,49	5,53	4,77	4,15	3,65	3,23	2,76	2,35	2,01	1,74	1,51	1,32
		Multiple	11,53	9,34	7,72	6,49	5,53	4,60	3,74	3,08	2,57	2,17	1,84	1,58	1,36	1,19	
	Suction	Single	8,80	7,12	5,89	4,95	4,06	3,25	2,64	2,18	1,82	1,53					
		Double	11,53	9,34	7,72	6,49	5,53	4,77	4,15	3,65	3,23	2,88	2,59	2,34	2,12	1,93	1,77
		Multiple	13,74	11,13	9,20	7,73	6,59	5,68	4,95	4,12	3,44	2,89	2,46	2,11	1,82	1,59	

pressure load - deflection limit L/200
suction load - deflection limit L/150
the load shown is the ultimate load divided by 1,5

APPLIED STANDARDS / NOTES

Tolerances/Coatings	EN 10143	Steel Quality	EN 10346	Handling	European Recommendations
Tests/Calculations	EN 1990, EN 1991 1-6, EN 1993 1-3, EN 1993 1-5 (Calculations are to Eurocode, however additional checks such as fixings are required)				
Deck self weight has not been allowed for, so has to be included in applied loads					

JI 56-225-900 Perfo Web (R5T12,5-O)

JI

Application:	Structural metal roof deck	Finishing:	Interior liner and Galvanised
Yield Stress (MPa):	320	Intermediate Support width:	≥60 mm
Ym:	1	End Support width:	≥40 mm

■ = perforated zone

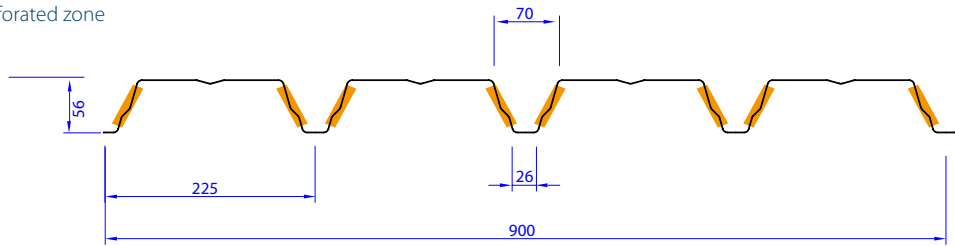

Mechanical Properties

tN [mm]	Weight (kg/m ²)	Broad flange in compression						Narrow flange in compression				
		Mc,Rk,F [kNm/m]	Mc,Rk,B [kNm/m]	I _{eff} [cm ⁴ /m]	Vw,Rk [kN/m]	Rw,Rk,B [kN/m]	Rw,Rk,A [kN/m]	Mc,Rk,F [kNm/m]	Mc,Rk,B [kNm/m]	I _{eff} [cm ⁴ /m]	Vw,Rk [kN/m]	Rw,Rk,A [kN/m]
0,75	8,02	3,23	2,81	35,22	49,03	19,75	8,54	2,81	3,23	36,08	49,03	49,03
0,88	9,41	4,05	3,33	41,92	67,39	27,60	11,97	3,33	4,05	42,67	67,39	67,39
1,00	10,69	4,81	3,80	48,20	79,10	35,82	15,58	3,80	4,81	48,76	79,10	79,10
1,25	13,37	6,40	4,79	61,43	99,63	55,83	24,41	4,79	6,40	61,42	99,63	99,63

Load type (kN/m²)

Thickness (mm)			Span (m)														
			1,60	1,80	2,00	2,20	2,40	2,60	2,80	3,00	3,20	3,40	3,60	3,80	4,00	4,20	4,40
0,75	Pressure	Single	6,73	4,87	3,55	2,67	2,05	1,62	1,29								
		Double	5,50	4,57	3,86	3,31	2,87	2,51	2,20	1,92	1,68	1,49	1,33	1,19	1,07		
		Multiple	6,55	5,32	4,31	3,56	2,99	2,55	2,20	1,92	1,64	1,37	1,15				
	Suction	Single	5,85	4,62	3,75	3,10	2,60	2,21	1,77								
		Double	6,73	5,32	4,31	3,56	2,99	2,55	2,20	1,92	1,68	1,49	1,33	1,19	1,08		
		Multiple	8,42	6,65	5,39	4,45	3,74	3,19	2,75	2,39	2,10	1,86	1,57				
0,88	Pressure	Single	8,25	5,80	4,23	3,17	2,45	1,92	1,54	1,25							
		Double	7,04	5,82	4,90	4,18	3,61	3,15	2,76	2,40	2,11	1,87	1,67	1,48	1,27	1,10	
		Multiple	8,42	6,67	5,40	4,46	3,75	3,20	2,76	2,37	1,95	1,63	1,37	1,17			
	Suction	Single	6,93	5,48	4,44	3,67	3,08	2,61	2,09	1,70							
		Double	8,44	6,67	5,40	4,46	3,75	3,20	2,76	2,40	2,11	1,87	1,67	1,50	1,35	1,22	
		Multiple	10,55	8,33	6,75	5,58	4,69	3,99	3,44	3,00	2,64	2,21	1,86	1,58			
1,00	Pressure	Single	9,49	6,66	4,86	3,65	2,81	2,21	1,77	1,44	1,19						
		Double	8,51	7,00	5,87	5,00	4,30	3,75	3,27	2,85	2,50	2,22	1,98	1,71	1,46	1,26	1,10
		Multiple	10,02	7,92	6,41	5,30	4,45	3,79	3,27	2,72	2,24	1,87	1,58	1,34	1,15		
	Suction	Single	7,92	6,26	5,07	4,19	3,52	2,98	2,39	1,94	1,60						
		Double	10,02	7,92	6,41	5,30	4,45	3,79	3,27	2,85	2,50	2,22	1,98	1,78	1,60	1,45	1,32
		Multiple	12,37	9,78	7,92	6,54	5,50	4,69	4,04	3,52	3,03	2,52	2,13	1,81	1,55		
1,25	Pressure	Single	12,09	8,49	6,19	4,65	3,58	2,82	2,26	1,83	1,51	1,26					
		Double	11,66	9,54	7,95	6,73	5,78	5,01	4,35	3,79	3,33	2,95	2,56	2,17	1,86	1,61	1,40
		Multiple	13,34	10,54	8,54	7,05	5,93	5,05	4,27	3,47	2,86	2,38	2,01	1,71	1,46	1,26	1,10
	Suction	Single	9,98	7,88	6,38	5,28	4,43	3,76	3,01	2,45	2,02	1,68					
		Double	13,34	10,54	8,54	7,05	5,93	5,05	4,35	3,79	3,33	2,95	2,63	2,36	2,13	1,94	1,76
		Multiple	15,59	12,32	9,98	8,25	6,93	5,90	5,09	4,43	3,81	3,18	2,68	2,28	1,95	1,69	1,47

pressure load - deflection limit L/200
suction load - deflection limit L/150
the load shown is the ultimate load divided by 1,5

APPLIED STANDARDS / NOTES

Tolerances/Coatings	EN 10143	Steel Quality	EN 10346	Handling	European Recommendations
Tests/Calculations	EN 1990, EN 1991 1-6, EN 1993 1-3, EN 1993 1-5 (Calculations are to Eurocode, however additional checks such as fixings are required)				
	Deck self weight has not been allowed for, so has to be included in applied loads				

JI 56-225-900 Perfo Full (R5T12,5-F)

JI

Application:	Structural metal roof deck	Finishing:	Interior liner and Galvanised
Yield Stress (MPa):	320	Intermediate Support width:	≥60 mm
Ym:	1	End Support width:	≥40 mm

■ = perforated zone

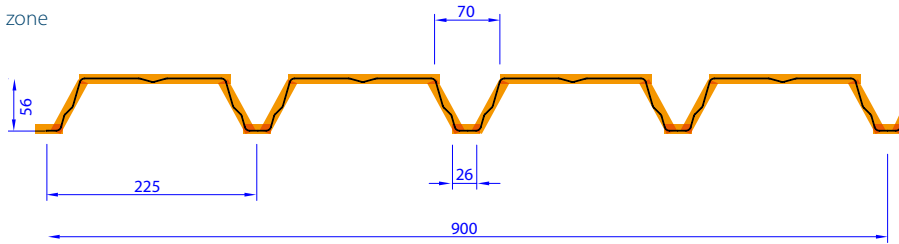

R5T12,5



Mechanical Properties

tN [mm]	Weight (kg/m ²)	Broad flange in compression						Narrow flange in compression				
		Mc,Rk,F [kNm/m]	Mc,Rk,B [kNm/m]	I _{eff} [cm ⁴ /m]	Vw,Rk [kN/m]	Rw,Rk,B [kN/m]	Rw,Rk,A [kN/m]	Mc,Rk,F [kNm/m]	Mc,Rk,B [kNm/m]	I _{eff} [cm ⁴ /m]	Vw,Rk [kN/m]	Rw,Rk,A [kN/m]
0,75	8,02	2,69	2,42	29,34	49,03	19,75	8,54	2,42	2,69	30,10	49,03	49,03
0,88	9,41	3,38	2,86	34,94	67,39	27,60	11,97	2,86	3,38	35,62	67,39	67,39
1,00	10,69	4,03	3,27	40,20	79,10	35,82	15,58	3,27	4,03	40,71	79,10	79,10
1,25	13,37	5,44	4,13	51,36	99,63	55,83	24,41	4,13	5,44	51,34	99,63	99,63

Load type (kN/m²)

Thickness (mm)			Span (m)														
			1,60	1,80	2,00	2,20	2,40	2,60	2,80	3,00	3,20	3,40	3,60	3,80	4,00	4,20	4,40
0,75	Pressure	Single	5,61	4,06	2,96	2,22	1,71	1,35									
		Double	5,08	4,20	3,54	2,97	2,49	2,13	1,83	1,60	1,40	1,24	1,11				
		Multiple	5,61	4,44	3,59	2,97	2,49	2,13	1,83	1,60	1,37	1,14					
	Suction	Single	5,03	3,98	3,22	2,66	2,24	1,84									
		Double	5,61	4,44	3,59	2,97	2,49	2,13	1,83	1,60	1,40	1,24	1,11				
		Multiple	7,02	5,54	4,49	3,71	3,12	2,66	2,29	2,00	1,75	1,55					
0,88	Pressure	Single	6,88	4,83	3,52	2,65	2,04	1,60	1,28								
		Double	6,47	5,32	4,46	3,73	3,13	2,67	2,30	2,00	1,76	1,56	1,39	1,24			
		Multiple	7,05	5,57	4,51	3,73	3,13	2,67	2,30	1,97	1,63	1,36	1,14				
	Suction	Single	5,96	4,71	3,82	3,15	2,65	2,18	1,74								
		Double	7,05	5,57	4,51	3,73	3,13	2,67	2,30	2,00	1,76	1,56	1,39	1,25			
		Multiple	8,81	6,96	5,64	4,66	3,91	3,34	2,88	2,50	2,20	1,84	1,55				
1,00	Pressure	Single	7,92	5,56	4,05	3,04	2,35	1,84	1,48	1,20							
		Double	7,78	6,38	5,32	4,45	3,74	3,18	2,74	2,39	2,10	1,86	1,66	1,42	1,22		
		Multiple	8,41	6,64	5,38	4,45	3,74	3,18	2,74	2,27	1,87	1,56	1,31	1,12			
	Suction	Single	6,82	5,39	4,36	3,61	3,03	2,49	1,99	1,62							
		Double	8,41	6,64	5,38	4,45	3,74	3,18	2,74	2,39	2,10	1,86	1,66	1,49	1,34		
		Multiple	10,51	8,30	6,72	5,56	4,67	3,98	3,43	2,99	2,53	2,11	1,77	1,51			
1,25	Pressure	Single	10,11	7,10	5,18	3,89	3,00	2,36	1,89	1,53	1,26						
		Double	10,59	8,63	7,17	5,99	5,03	4,29	3,70	3,22	2,83	2,51	2,14	1,82	1,56	1,35	1,17
		Multiple	11,33	8,95	7,25	5,99	5,03	4,29	3,57	2,90	2,39	1,99	1,68	1,43	1,22		
	Suction	Single	8,60	6,79	5,50	4,55	3,82	3,14	2,51	2,04	1,68						
		Double	11,33	8,95	7,25	5,99	5,03	4,29	3,70	3,22	2,83	2,51	2,24	2,01	1,81	1,64	1,50
		Multiple	13,43	10,61	8,60	7,10	5,97	5,09	4,39	3,82	3,19	2,66	2,24	1,90	1,63		

pressure load - deflection limit L/200
suction load - deflection limit L/150
the load shown is the ultimate load divided by 1,5

APPLIED STANDARDS / NOTES

Tolerances/Coatings	EN 10143	Steel Quality	EN 10346	Handling	European Recommendations
Tests/Calculations	EN 1990, EN 1991 1-6, EN 1993 1-3, EN 1993 1-5 (Calculations are to Eurocode, however additional checks such as fixings are required)				
Deck self weight has not been allowed for, so has to be included in applied loads					

JI 73-195-780

JI

Application:	Structural metal roof deck	Finishing:	Interior liner and Galvanised
Yield Stress (MPa):	320	Intermediate Support width:	≥60 mm
Ym:	1	End Support width:	≥40 mm

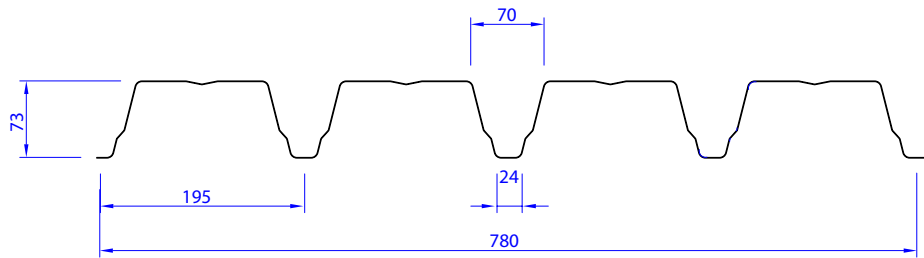

Mechanical Properties

tN [mm]	Weight (kg/m ²)	Broad flange in compression						Narrow flange in compression				
		Mc,Rk,F [kNm/m]	Mc,Rk,B [kNm/m]	I _{eff} [cm ⁴ /m]	Vw,Rk [kN/m]	Rw,Rk,B [kN/m]	Rw,Rk,A [kN/m]	Mc,Rk,F [kNm/m]	Mc,Rk,B [kNm/m]	I _{eff} [cm ⁴ /m]	Vw,Rk [kN/m]	Rw,Rk,A [kN/m]
0,75	8,52	5,48	5,09	76,39	73,91	31,01	13,45	5,09	5,48	77,17	73,91	73,91
0,88	10,00	6,83	6,02	91,32	101,70	43,26	18,83	6,02	6,83	91,25	101,70	101,70
1,00	11,36	8,13	6,88	105,33	131,11	56,09	24,49	6,88	8,13	104,24	131,11	131,11
1,25	14,20	10,94	8,66	132,99	171,29	87,36	38,34	8,66	10,94	131,25	171,29	171,29

Load type (kN/m²)

Thickness (mm)			Span (m)															
			2,80	3,00	3,20	3,40	3,60	3,80	4,00	4,20	4,40	4,60	4,80	5,00	5,20	5,40	5,60	
0,75	Pressure	Single	2,81	2,28	1,88	1,57	1,32	1,12										
		Double	3,73	3,25	2,85	2,53	2,25	2,02	1,83	1,66	1,51	1,38	1,27	1,17				
		Multiple	3,73	3,25	2,85	2,53	2,25	2,05	1,82	1,57	1,37	1,20						
	Suction	Single	3,46	3,02	2,53	2,11	1,78	1,51										
		Double	3,73	3,25	2,85	2,53	2,25	2,02	1,83	1,66	1,51	1,38	1,27	1,17				
		Multiple	4,66	4,06	3,57	3,16	2,82	2,53	2,28	2,07	1,84	1,61						
0,88	Pressure	Single	3,35	2,73	2,25	1,87	1,58	1,34	1,15									
		Double	4,65	4,05	3,56	3,15	2,81	2,52	2,28	2,07	1,88	1,72	1,58	1,42	1,26	1,13		
		Multiple	4,65	4,05	3,56	3,15	2,81	2,54	2,18	1,88	1,64	1,43	1,26	1,11				
	Suction	Single	4,09	3,57	2,99	2,50	2,10	1,79	1,53									
		Double	4,65	4,05	3,56	3,15	2,81	2,52	2,28	2,07	1,88	1,72	1,58	1,46	1,35	1,25		
		Multiple	5,81	5,06	4,45	3,94	3,51	3,15	2,85	2,50	2,18	1,91	1,68	1,48				
1,00	Pressure	Single	3,87	3,15	2,59	2,16	1,82	1,55	1,33	1,15								
		Double	5,53	4,82	4,23	3,75	3,35	3,00	2,71	2,46	2,24	2,05	1,85	1,64	1,46	1,30	1,17	
		Multiple	5,53	4,82	4,23	3,75	3,35	2,93	2,51	2,17	1,89	1,65	1,45	1,29	1,14			
	Suction	Single	4,68	4,07	3,42	2,85	2,40	2,04	1,75	1,51								
		Double	5,53	4,82	4,23	3,75	3,35	3,00	2,71	2,46	2,24	2,05	1,88	1,73	1,60	1,49	1,38	
		Multiple	6,91	6,02	5,29	4,69	4,18	3,75	3,31	2,86	2,49	2,18	1,92	1,70	1,51			
1,25	Pressure	Single	4,89	3,97	3,27	2,73	2,30	1,95	1,68	1,45	1,26	1,10						
		Double	7,44	6,48	5,70	5,05	4,50	4,04	3,65	3,31	3,01	2,65	2,34	2,07	1,84	1,64	1,47	
		Multiple	7,44	6,48	5,70	5,05	4,35	3,70	3,17	2,74	2,38	2,08	1,83	1,62	1,44	1,29	1,16	
	Suction	Single	5,89	5,13	4,31	3,59	3,02	2,57	2,21	1,90	1,66	1,45						
		Double	7,44	6,48	5,70	5,05	4,50	4,04	3,65	3,31	3,01	2,76	2,53	2,33	2,16	2,00	1,86	
		Multiple	9,20	8,02	7,05	6,24	5,57	4,86	4,17	3,60	3,13	2,74	2,41	2,14	1,90	1,70	1,52	

pressure load - deflection limit L/200
suction load - deflection limit L/150
the load shown is the ultimate load divided by 1,5

APPLIED STANDARDS / NOTES

Tolerances/Coatings	EN 10143	Steel Quality	EN 10346	Handling	European Recommendations
Tests/Calculations	EN 1990, EN 1991 1-6, EN 1993 1-3, EN 1993 1-5 (Calculations are to Eurocode, however additional checks such as fixings are required)				
	Deck self weight has not been allowed for, so has to be included in applied loads				

JI 73-195-780 Perfo Web (R5T12,5-O)

JI

Application:	Structural metal roof deck	Finishing:	Interior liner and Galvanised
Yield Stress (MPa):	320	Intermediate Support width:	≥60 mm
Ym:	1	End Support width:	≥40 mm

■ = perforated zone

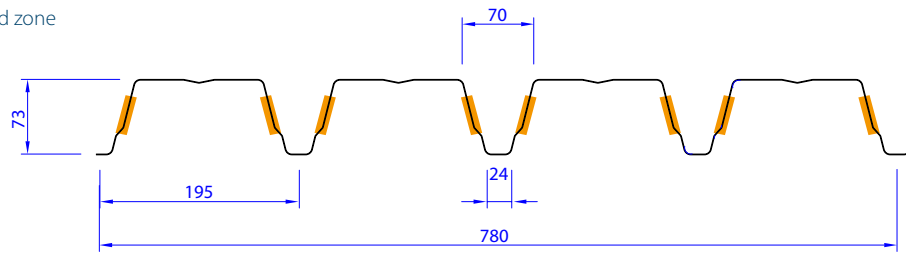

Mechanical Properties

tN [mm]	Weight (kg/m ²)	Broad flange in compression						Narrow flange in compression				
		Mc,Rk,F [kNm/m]	Mc,Rk,B [kNm/m]	I _{eff} [cm ⁴ /m]	Vw,Rk [kN/m]	Rw,Rk,B [kN/m]	Rw,Rk,A [kN/m]	Mc,Rk,F [kNm/m]	Mc,Rk,B [kNm/m]	I _{eff} [cm ⁴ /m]	Vw,Rk [kN/m]	Rw,Rk,A [kN/m]
0,75	8,36	5,25	4,85	74,08	53,87	22,30	9,64	4,85	5,25	74,72	53,87	53,87
0,88	9,81	6,57	5,74	88,55	74,21	31,19	13,53	5,74	6,57	88,36	74,21	74,21
1,00	11,14	7,82	6,56	102,11	95,76	40,51	17,62	6,56	7,82	100,94	95,76	95,76
1,25	13,93	10,50	8,26	128,92	142,58	63,23	27,64	8,26	10,50	127,10	142,58	142,58

Load type (kN/m²)

Thickness (mm)			Span (m)														
			2,60	2,80	3,00	3,20	3,40	3,60	3,80	4,00	4,20	4,40	4,60	4,80	5,00	5,20	5,40
0,75	Pressure	Single	3,40	2,72	2,21	1,82	1,52	1,28									
		Double	3,63	3,23	2,90	2,61	2,37	2,16	1,94	1,75	1,59	1,45	1,32	1,22	1,12		
		Multiple	4,15	3,57	3,11	2,74	2,42	2,16	1,94	1,75	1,53	1,33	1,16				
	Suction	Single	3,83	3,30	2,88	2,45	2,04	1,72									
		Double	4,15	3,57	3,11	2,74	2,42	2,16	1,94	1,75	1,59	1,45	1,32	1,22	1,12		
		Multiple	5,18	4,47	3,89	3,42	3,03	2,70	2,43	2,19	1,99	1,78	1,56				
0,88	Pressure	Single	4,06	3,25	2,64	2,18	1,82	1,53	1,30	1,12							
		Double	4,63	4,11	3,67	3,30	2,98	2,70	2,42	2,19	1,98	1,81	1,65	1,52	1,38	1,22	
		Multiple	5,18	4,47	3,89	3,42	3,03	2,70	2,42	2,11	1,82	1,59	1,39	1,22			
	Suction	Single	4,53	3,91	3,40	2,90	2,42	2,04	1,73	1,48							
		Double	5,18	4,47	3,89	3,42	3,03	2,70	2,42	2,19	1,98	1,81	1,65	1,52	1,40	1,29	
		Multiple	6,47	5,58	4,86	4,27	3,79	3,38	3,03	2,74	2,43	2,11	1,85	1,62			
1,00	Pressure	Single	4,68	3,75	3,05	2,51	2,10	1,76	1,50	1,29	1,11						
		Double	5,58	4,94	4,40	3,95	3,56	3,22	2,89	2,61	2,36	2,15	1,97	1,79	1,59	1,41	1,26
		Multiple	6,17	5,32	4,63	4,07	3,61	3,22	2,84	2,43	2,10	1,83	1,60	1,41	1,25	1,11	
	Suction	Single	5,17	4,46	3,89	3,31	2,76	2,33	1,98	1,70	1,46						
		Double	6,17	5,32	4,63	4,07	3,61	3,22	2,89	2,61	2,36	2,15	1,97	1,81	1,67	1,54	1,43
		Multiple	7,71	6,65	5,79	5,09	4,51	4,02	3,61	3,21	2,77	2,41	2,11	1,86	1,64	1,46	
1,25	Pressure	Single	5,92	4,74	3,85	3,17	2,65	2,23	1,89	1,62	1,40	1,22					
		Double	7,61	6,71	5,96	5,33	4,80	4,32	3,88	3,50	3,17	2,89	2,57	2,26	2,00	1,78	1,59
		Multiple	8,28	7,14	6,22	5,47	4,84	4,21	3,58	3,07	2,65	2,31	2,02	1,78	1,57	1,40	1,25
	Suction	Single	6,51	5,62	4,89	4,17	3,48	2,93	2,49	2,14	1,84	1,60					
		Double	8,28	7,14	6,22	5,47	4,84	4,32	3,88	3,50	3,17	2,89	2,65	2,43	2,24	2,07	1,92
		Multiple	10,18	8,77	7,64	6,72	5,95	5,31	4,71	4,04	3,49	3,03	2,66	2,34	2,07	1,84	1,64

pressure load - deflection limit L/200
suction load - deflection limit L/150
the load shown is the ultimate load divided by 1,5

APPLIED STANDARDS / NOTES

Tolerances/Coatings	EN 10143	Steel Quality	EN 10346	Handling	European Recommendations
Tests/Calculations	EN 1990, EN 1991 1-6, EN 1993 1-3, EN 1993 1-5 (Calculations are to Eurocode, however additional checks such as fixings are required)				
Deck self weight has not been allowed for, so has to be included in applied loads					

JI 73-195-780 Perfo Full (R5T12,5-F)

JI

Application:	Structural metal roof deck	Finishing:	Interior liner and Galvanised
Yield Stress (MPa):	320	Intermediate Support width:	≥60 mm
Ym:	1	End Support width:	≥40 mm

■ = perforated zone

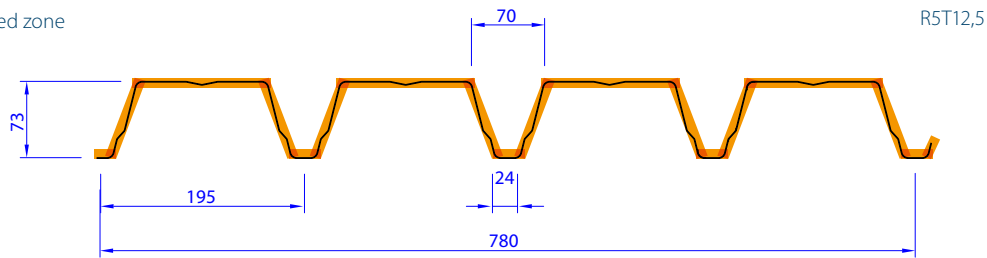

Mechanical Properties

tN [mm]	Weight (kg/m ²)	Broad flange in compression						Narrow flange in compression				
		Mc,Rk,F [kNm/m]	Mc,Rk,B [kNm/m]	I _{eff} [cm ⁴ /m]	Vw,Rk [kN/m]	Rw,Rk,B [kN/m]	Rw,Rk,A [kN/m]	Mc,Rk,F [kNm/m]	Mc,Rk,B [kNm/m]	I _{eff} [cm ⁴ /m]	Vw,Rk [kN/m]	Rw,Rk,A [kN/m]
0,75	8,52	4,48	4,30	62,84	53,87	22,30	9,64	4,30	4,48	63,83	53,87	53,87
0,88	10,00	5,57	5,09	75,05	74,21	31,19	13,53	5,09	5,57	75,50	74,21	74,21
1,00	11,36	6,63	5,81	86,53	95,76	40,51	17,62	5,81	6,63	86,28	95,76	95,76
1,25	14,20	8,91	7,32	109,33	142,58	63,23	27,64	7,32	8,91	108,73	142,58	142,58

Load type (kN/m²)

Thickness (mm)			Span (m)														
			2,60	2,80	3,00	3,20	3,40	3,60	3,80	4,00	4,20	4,40	4,60	4,80	5,00	5,20	5,40
0,75	Pressure	Single	2,88	2,31	1,88	1,55	1,29										
		Double	3,40	3,02	2,65	2,33	2,07	1,84	1,65	1,49	1,35	1,23	1,13				
		Multiple	3,53	3,05	2,65	2,33	2,07	1,84	1,65	1,50	1,29	1,13					
	Suction	Single	3,39	2,92	2,54	2,09	1,75										
		Double	3,53	3,05	2,65	2,33	2,07	1,84	1,65	1,49	1,35	1,23	1,13				
		Multiple	4,42	3,81	3,32	2,92	2,58	2,30	2,07	1,87	1,69	1,52					
0,88	Pressure	Single	3,44	2,76	2,24	1,85	1,54	1,30	1,10								
		Double	4,31	3,79	3,30	2,90	2,57	2,29	2,06	1,86	1,68	1,54	1,40	1,29	1,17		
		Multiple	4,40	3,79	3,30	2,90	2,57	2,29	2,06	1,79	1,54	1,34	1,18				
	Suction	Single	4,01	3,46	3,01	2,48	2,07	1,74	1,48								
		Double	4,40	3,79	3,30	2,90	2,57	2,29	2,06	1,86	1,68	1,54	1,40	1,29	1,19		
		Multiple	5,50	4,74	4,13	3,63	3,21	2,87	2,57	2,32	2,07	1,80	1,58				
1,00	Pressure	Single	3,97	3,18	2,58	2,13	1,78	1,50	1,27								
		Double	5,18	4,51	3,93	3,45	3,06	2,73	2,45	2,21	2,00	1,83	1,67	1,52	1,34	1,20	
		Multiple	5,23	4,51	3,93	3,45	3,06	2,73	2,41	2,06	1,78	1,55	1,36	1,19			
	Suction	Single	4,59	3,95	3,44	2,83	2,36	1,99	1,69								
		Double	5,23	4,51	3,93	3,45	3,06	2,73	2,45	2,21	2,00	1,83	1,67	1,53	1,41	1,31	
		Multiple	6,53	5,63	4,91	4,31	3,82	3,41	3,06	2,74	2,37	2,06	1,80	1,59			
1,25	Pressure	Single	5,02	4,02	3,27	2,69	2,24	1,89	1,61	1,38	1,19						
		Double	7,02	6,06	5,28	4,64	4,11	3,67	3,29	2,97	2,69	2,45	2,18	1,92	1,70	1,51	1,35
		Multiple	7,03	6,06	5,28	4,64	4,11	3,57	3,04	2,61	2,25	1,96	1,71	1,51	1,33	1,19	
	Suction	Single	5,78	4,98	4,33	3,57	2,97	2,51	2,13	1,83	1,58						
		Double	7,03	6,06	5,28	4,64	4,11	3,67	3,29	2,97	2,69	2,45	2,25	2,06	1,90	1,76	1,63
		Multiple	8,79	7,58	6,60	5,80	5,14	4,58	4,03	3,45	2,98	2,60	2,27	2,00	1,77	1,57	

pressure load - deflection limit L/200
suction load - deflection limit L/150
the load shown is the ultimate load divided by 1,5

APPLIED STANDARDS / NOTES

Tolerances/Coatings	EN 10143	Steel Quality	EN 10346	Handling	European Recommendations
Tests/Calculations	EN 1990, EN 1991 1-6, EN 1993 1-3, EN 1993 1-5 (Calculations are to Eurocode, however additional checks such as fixings are required)				
	Deck self weight has not been allowed for, so has to be included in applied loads				

JI 85-280-1120

JI

Application:	Structural metal roof deck	Finishing:	Interior liner and Galvanised
Yield Stress (MPa):	320	Intermediate Support width:	≥160 mm
Ym:	1	End Support width:	≥40 mm

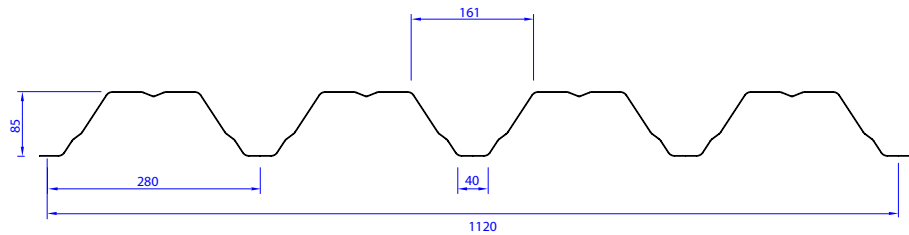

Mechanical Properties

tN [mm]	Weight (kg/m ²)	Broad flange in compression						Narrow flange in compression				
		Mc,Rk,F [kNm/m]	Mc,Rk,B [kNm/m]	I _{eff} [cm ⁴ /m]	Vw,Rk [kN/m]	Rw,Rk,B [kN/m]	Rw,Rk,A [kN/m]	Mc,Rk,F [kNm/m]	Mc,Rk,B [kNm/m]	I _{eff} [cm ⁴ /m]	Vw,Rk [kN/m]	Rw,Rk,A [kN/m]
0,75	7,90	5,75	5,17	87,17	46,57	25,44	7,57	5,17	5,75	89,22	46,57	46,57
0,88	9,27	7,27	6,36	106,44	71,00	35,73	10,75	6,36	7,27	108,54	71,00	71,00
1,00	10,53	8,76	7,49	124,02	91,59	46,49	14,12	7,49	8,76	124,03	91,59	91,59
1,25	13,16	11,90	9,87	156,27	142,56	72,61	22,42	9,87	11,90	156,28	142,56	142,56

Load type (kN/m²)

Thickness (mm)			Span (m)														
			3,20	3,40	3,60	3,80	4,00	4,20	4,40	4,60	4,80	5,00	5,20	5,40	5,60	5,80	6,00
0,75	Pressure	Single	2,15	1,79	1,51	1,28	1,10										
		Double	2,99	2,65	2,36	2,12	1,92	1,74	1,58	1,45	1,33	1,23	1,13				
		Multiple	2,99	2,65	2,36	2,12	1,92	1,74	1,56	1,37	1,20						
	Suction	Single	2,69	2,38	2,06	1,75	1,50										
		Double	2,99	2,65	2,36	2,12	1,92	1,74	1,58	1,45	1,33	1,23	1,13				
		Multiple	3,74	3,31	2,96	2,65	2,39	2,17	1,98	1,81	1,64						
0,88	Pressure	Single	2,62	2,18	1,84	1,56	1,34	1,16									
		Double	3,79	3,36	2,99	2,69	2,42	2,20	2,00	1,83	1,68	1,55	1,43	1,31	1,18		
		Multiple	3,79	3,36	2,99	2,69	2,42	2,19	1,91	1,67	1,47	1,30	1,15				
	Suction	Single	3,31	2,93	2,50	2,13	1,82	1,58									
		Double	3,79	3,36	2,99	2,69	2,42	2,20	2,00	1,83	1,68	1,55	1,43	1,33	1,24		
		Multiple	4,73	4,19	3,74	3,36	3,03	2,75	2,50	2,27	2,00	1,77	1,57				
1,00	Pressure	Single	3,05	2,54	2,14	1,82	1,56	1,35	1,17								
		Double	4,56	4,04	3,60	3,23	2,92	2,65	2,41	2,21	2,03	1,87	1,71	1,53	1,37	1,23	1,12
		Multiple	4,56	4,04	3,60	3,23	2,92	2,55	2,22	1,94	1,71	1,51	1,35	1,20			
	Suction	Single	3,90	3,39	2,86	2,43	2,08	1,80	1,57								
		Double	4,56	4,04	3,60	3,23	2,92	2,65	2,41	2,21	2,03	1,87	1,73	1,60	1,49	1,39	1,30
		Multiple	5,70	5,05	4,50	4,04	3,65	3,31	2,96	2,59	2,28	2,02	1,79	1,60			
1,25	Pressure	Single	3,85	3,21	2,70	2,30	1,97	1,70	1,48	1,29	1,14						
		Double	6,20	5,49	4,90	4,39	3,97	3,60	3,28	3,00	2,74	2,43	2,16	1,93	1,73	1,56	1,41
		Multiple	6,20	5,49	4,90	4,34	3,72	3,22	2,80	2,45	2,16	1,91	1,70	1,51	1,36	1,22	1,10
	Suction	Single	5,13	4,28	3,60	3,06	2,63	2,27	1,97	1,73	1,52						
		Double	6,20	5,49	4,90	4,39	3,97	3,60	3,28	3,00	2,75	2,54	2,35	2,18	2,02	1,89	1,76
		Multiple	7,75	6,86	6,12	5,49	4,96	4,29	3,73	3,27	2,87	2,54	2,26	2,02	1,81	1,63	1,47

pressure load - deflection limit L/200
suction load - deflection limit L/150
the load shown is the ultimate load divided by 1,5

APPLIED STANDARDS / NOTES

Tolerances/Coatings	EN 10143	Steel Quality	EN 10346	Handling	European Recommendations
Tests/Calculations	EN 1990, EN 1991 1-6, EN 1993 1-3, EN 1993 1-5 (Calculations are to Eurocode, however additional checks such as fixings are required)				
	Deck self weight has not been allowed for, so has to be included in applied loads				

JI 85-280-1120 Perfo Web (R5T12,5-DO)

JI

Application:	Structural metal roof deck	Finishing:	Interior liner and Galvanised
Yield Stress (MPa):	320	Intermediate Support width:	≥160 mm
Ym:	1	End Support width:	≥40 mm

■ = perforated zone

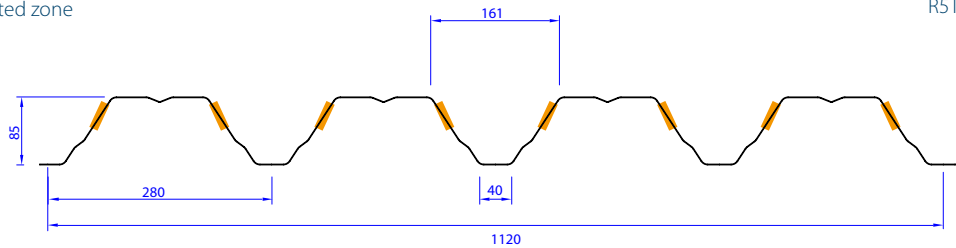

Mechanical Properties

tN [mm]	Weight (kg/m ²)	Broad flange in compression						Narrow flange in compression				
		Mc,Rk,F [kNm/m]	Mc,Rk,B [kNm/m]	I _{eff} [cm ⁴ /m]	Vw,Rk [kN/m]	Rw,Rk,B [kN/m]	Rw,Rk,A [kN/m]	Mc,Rk,F [kNm/m]	Mc,Rk,B [kNm/m]	I _{eff} [cm ⁴ /m]	Vw,Rk [kN/m]	Rw,Rk,A [kN/m]
0,75	7,90	5,26	5,09	85,55	31,46	20,01	5,91	5,09	5,26	87,88	31,46	31,46
0,88	9,27	6,98	6,27	104,62	50,49	28,21	8,42	6,27	6,98	106,93	50,49	50,49
1,00	10,53	8,45	7,39	122,01	70,59	36,79	11,08	7,39	8,45	122,19	70,59	70,59
1,25	13,16	11,57	9,75	153,74	110,00	57,65	17,64	9,75	11,57	153,97	110,00	110,00

Load type (kN/m²)

Thickness (mm)			Span (m)														
			3,00	3,20	3,40	3,60	3,80	4,00	4,20	4,40	4,60	4,80	5,00	5,20	5,40	5,60	5,80
0,75	Pressure	Single	2,56	2,11	1,76	1,48	1,26										
		Double	2,63	2,46	2,32	2,16	1,94	1,75	1,59	1,45	1,33	1,22	1,12				
		Multiple	2,63	2,46	2,32	2,16	1,94	1,75	1,59	1,45	1,33	1,18					
	Suction	Single	3,02	2,65	2,35	2,03	1,72										
		Double	3,12	2,74	2,43	2,16	1,94	1,75	1,59	1,45	1,33	1,22	1,12				
		Multiple	3,89	3,42	3,03	2,70	2,43	2,19	1,99	1,81	1,66	1,52					
0,88	Pressure	Single	3,12	2,57	2,15	1,81	1,54	1,32	1,14								
		Double	3,74	3,51	3,17	2,87	2,58	2,33	2,11	1,92	1,76	1,61	1,49	1,38	1,28	1,16	
		Multiple	3,74	3,51	3,22	2,87	2,58	2,33	2,11	1,87	1,64	1,44	1,28	1,13			
	Suction	Single	3,72	3,27	2,89	2,46	2,10	1,80	1,55								
		Double	4,13	3,63	3,22	2,87	2,58	2,33	2,11	1,92	1,76	1,61	1,49	1,38	1,28	1,19	
		Multiple	5,17	4,54	4,02	3,59	3,22	2,91	2,64	2,40	2,20	1,97	1,74	1,55			
1,00	Pressure	Single	3,64	3,00	2,50	2,11	1,79	1,54	1,33	1,15							
		Double	4,80	4,32	3,90	3,48	3,12	2,82	2,56	2,33	2,13	1,96	1,80	1,67	1,51	1,35	1,21
		Multiple	4,92	4,40	3,90	3,48	3,12	2,82	2,51	2,18	1,91	1,68	1,49	1,32	1,18		
	Suction	Single	4,38	3,85	3,34	2,82	2,39	2,05	1,77	1,54							
		Double	5,01	4,40	3,90	3,48	3,12	2,82	2,56	2,33	2,13	1,96	1,80	1,67	1,55	1,44	1,34
		Multiple	6,26	5,50	4,87	4,35	3,90	3,52	3,19	2,91	2,55	2,25	1,99	1,77	1,58		
1,25	Pressure	Single	4,59	3,78	3,15	2,66	2,26	1,94	1,67	1,46	1,27	1,12					
		Double	6,80	6,03	5,34	4,76	4,27	3,86	3,50	3,19	2,92	2,68	2,39	2,12	1,90	1,70	1,53
		Multiple	6,86	6,03	5,34	4,76	4,27	3,66	3,17	2,75	2,41	2,12	1,88	1,67	1,49	1,34	1,20
	Suction	Single	5,78	5,05	4,21	3,55	3,02	2,59	2,23	1,94	1,70	1,50					
		Double	6,86	6,03	5,34	4,76	4,27	3,86	3,50	3,19	2,92	2,68	2,47	2,28	2,12	1,97	1,83
		Multiple	8,57	7,53	6,67	5,95	5,34	4,82	4,23	3,68	3,22	2,83	2,51	2,23	1,99	1,78	1,60

pressure load - deflection limit L/200
suction load - deflection limit L/150
the load shown is the ultimate load divided by 1,5

APPLIED STANDARDS / NOTES

Tolerances/Coatings	EN 10143	Steel Quality	EN 10346	Handling	European Recommendations
Tests/Calculations	EN 1990, EN 1991 1-6, EN 1993 1-3, EN 1993 1-5 (Calculations are to Eurocode, however additional checks such as fixings are required)				
	Deck self weight has not been allowed for, so has to be included in applied loads				

J1 106-250-750

J1

Application:	Structural metal roof deck	Finishing:	Interior liner and Galvanised
Yield Stress (MPa):	320	Intermediate Support width:	≥160 mm
Ym:	1	End Support width:	≥40 mm

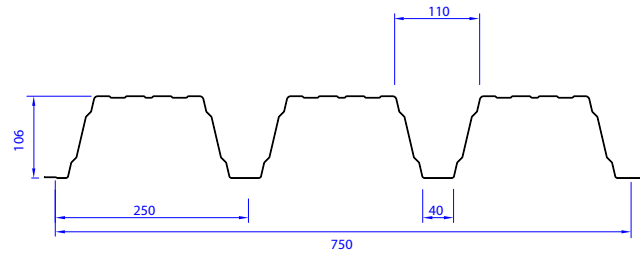

Mechanical Properties

tN [mm]	Weight (kg/m ²)	Broad flange in compression						Narrow flange in compression				
		Mc,Rk,F [kNm/m]	Mc,Rk,B [kNm/m]	Ieff [cm ⁴ /m]	Vw,Rk [kN/m]	Rw,Rk,B [kN/m]	Rw,Rk,A [kN/m]	Mc,Rk,F [kNm/m]	Mc,Rk,B [kNm/m]	Ieff [cm ⁴ /m]	Vw,Rk [kN/m]	Rw,Rk,A [kN/m]
0,75	9,81	7,70	7,78	169,55	50,11	37,11	11,05	7,78	7,70	175,29	50,11	50,11
0,88	11,51	9,60	9,58	203,69	80,04	51,00	15,35	9,58	9,60	212,37	80,04	80,04
1,00	13,08	11,35	11,27	235,76	103,83	65,39	19,86	11,27	11,35	242,64	103,83	103,83
1,25	16,35	14,77	14,75	303,99	161,21	99,97	30,87	14,75	14,77	305,62	161,21	161,21

Load type (kN/m²)

Thickness (mm)			Span (m)														
			4,40	4,60	4,80	5,00	5,20	5,40	5,60	5,80	6,00	6,20	6,40	6,60	6,80	7,00	7,20
0,75	Pressure	Single	1,61	1,40	1,24												
		Double	2,12	1,94	1,78	1,64	1,52	1,41	1,31	1,22	1,14						
		Multiple	2,33	2,16	2,01	1,88	1,75	1,64	1,47	1,33	1,20						
	Suction	Single	2,14	1,94	1,70												
		Double	2,12	1,94	1,78	1,64	1,52	1,41	1,31	1,22	1,14						
		Multiple	2,65	2,43	2,23	2,05	1,90	1,76	1,64	1,53	1,43						
0,88	Pressure	Single	1,93	1,69	1,49	1,31	1,17										
		Double	2,64	2,42	2,22	2,05	1,89	1,76	1,63	1,52	1,42	1,33	1,25	1,18	1,11		
		Multiple	2,99	2,77	2,57	2,39	2,21	1,97	1,77	1,59	1,44	1,30	1,19				
	Suction	Single	2,64	2,35	2,06	1,83	1,62										
		Double	2,64	2,42	2,22	2,05	1,89	1,76	1,63	1,52	1,42	1,33	1,25	1,18	1,11		
		Multiple	3,31	3,02	2,78	2,56	2,37	2,19	2,04	1,90	1,78	1,66	1,56				
1,00	Pressure	Single	2,23	1,95	1,72	1,52	1,35	1,21									
		Double	3,13	2,86	2,63	2,42	2,24	2,08	1,93	1,80	1,68	1,57	1,48	1,39	1,31	1,24	1,17
		Multiple	3,62	3,35	3,10	2,88	2,56	2,28	2,05	1,84	1,66	1,51	1,37	1,25	1,14		
	Suction	Single	3,06	2,68	2,36	2,09	1,86	1,66									
		Double	3,13	2,86	2,63	2,42	2,24	2,08	1,93	1,80	1,68	1,57	1,48	1,39	1,31	1,24	1,17
		Multiple	3,91	3,58	3,28	3,03	2,80	2,59	2,41	2,25	2,10	1,97	1,85	1,72	1,57		
1,25	Pressure	Single	2,88	2,52	2,22	1,96	1,74	1,56	1,40	1,26	1,13						
		Double	4,07	3,72	3,42	3,15	2,91	2,70	2,51	2,34	2,19	2,05	1,92	1,81	1,70	1,61	1,52
		Multiple	4,96	4,58	4,19	3,71	3,30	2,94	2,64	2,38	2,15	1,95	1,77	1,61	1,47	1,35	1,24
	Suction	Single	3,86	3,38	2,97	2,63	2,34	2,09	1,87	1,68	1,52						
		Double	4,07	3,72	3,42	3,15	2,91	2,70	2,51	2,34	2,19	2,05	1,92	1,81	1,70	1,61	1,52
		Multiple	5,09	4,65	4,27	3,94	3,64	3,38	3,14	2,93	2,74	2,56	2,37	2,16	1,98	1,81	1,67

pressure load - deflection limit L/200
suction load - deflection limit L/150
the load shown is the ultimate load divided by 1,5

APPLIED STANDARDS / NOTES

Tolerances/Coatings	EN 10143	Steel Quality	EN 10346	Handling	European Recommendations
Tests/Calculations	EN 1990, EN 1991 1-6, EN 1993 1-3, EN 1993 1-5 (Calculations are to Eurocode, however additional checks such as fixings are required)				
	Deck self weight has not been allowed for, so has to be included in applied loads				

JI 106-250-750 Perfo Web (R5T12,5-DO)

JI

Application:	Structural metal roof deck	Finishing:	Interior liner and Galvanised
Yield Stress (MPa):	320	Intermediate Support width:	≥160 mm
Ym:	1	End Support width:	≥40 mm

 = perforated zone

R5T12,5

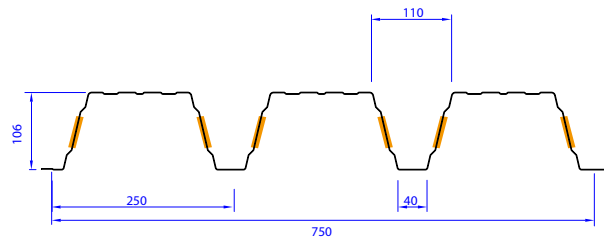

Mechanical Properties

tN [mm]	Weight (kg/m ²)	Broad flange in compression						Narrow flange in compression				
		Mc,Rk,F [kNm/m]	Mc,Rk,B [kNm/m]	I _{eff} [cm ⁴ /m]	Vw,Rk [kN/m]	Rw,Rk,B [kN/m]	Rw,Rk,A [kN/m]	Mc,Rk,F [kNm/m]	Mc,Rk,B [kNm/m]	I _{eff} [cm ⁴ /m]	Vw,Rk [kN/m]	Rw,Rk,A [kN/m]
0,75	9,81	7,56	7,26	164,64	31,84	26,86	7,90	7,26	7,56	169,12	31,84	31,84
0,88	11,51	9,42	9,02	197,74	50,98	37,00	11,00	9,02	9,42	205,28	50,98	50,98
1,00	13,08	11,13	10,63	228,81	74,18	47,52	14,26	10,63	11,13	234,52	74,18	74,18
1,25	16,35	14,47	13,95	294,89	117,55	72,80	22,19	13,95	14,47	295,40	117,55	117,55

Load type (kN/m²)

Thickness (mm)			Span (m)														
			4,00	4,20	4,40	4,60	4,80	5,00	5,20	5,40	5,60	5,80	6,00	6,20	6,40	6,60	6,80
0,75	Pressure	Single	2,07	1,79	1,56	1,36	1,20										
		Double	2,52	2,28	2,08	1,90	1,75	1,61	1,49	1,38	1,29	1,20	1,12				
		Multiple	2,52	2,28	2,08	1,90	1,75	1,61	1,49	1,40	1,32	1,24	1,16				
	Suction	Single	2,42	2,19	2,00	1,83	1,64										
		Double	2,52	2,28	2,08	1,90	1,75	1,61	1,49	1,38	1,29	1,20	1,12				
		Multiple	3,15	2,86	2,60	2,38	2,19	2,02	1,86	1,73	1,61	1,50	1,40				
0,88	Pressure	Single	2,49	2,15	1,87	1,64	1,44	1,28	1,13								
		Double	3,14	2,85	2,59	2,37	2,18	2,01	1,86	1,72	1,60	1,49	1,39	1,31	1,23	1,15	
		Multiple	3,14	2,85	2,59	2,37	2,21	2,06	1,93	1,81	1,70	1,55	1,40	1,27	1,15		
	Suction	Single	3,01	2,73	2,48	2,27	2,00	1,77	1,57								
		Double	3,14	2,85	2,59	2,37	2,18	2,01	1,86	1,72	1,60	1,49	1,39	1,31	1,23	1,15	
		Multiple	3,92	3,56	3,24	2,97	2,72	2,51	2,32	2,15	2,00	1,87	1,74	1,63	1,53		
1,00	Pressure	Single	2,88	2,49	2,17	1,90	1,67	1,48	1,31	1,17							
		Double	3,71	3,36	3,06	2,80	2,58	2,37	2,19	2,03	1,89	1,76	1,65	1,54	1,45	1,36	1,28
		Multiple	3,71	3,36	3,11	2,89	2,69	2,51	2,34	2,20	1,99	1,79	1,62	1,46	1,33	1,21	1,11
	Suction	Single	3,54	3,21	2,93	2,59	2,28	2,02	1,79	1,60							
		Double	3,71	3,36	3,06	2,80	2,58	2,37	2,19	2,03	1,89	1,76	1,65	1,54	1,45	1,36	1,28
		Multiple	4,64	4,20	3,83	3,51	3,22	2,97	2,74	2,54	2,37	2,20	2,06	1,93	1,81	1,66	1,52
1,25	Pressure	Single	3,72	3,21	2,79	2,44	2,15	1,90	1,69	1,51	1,35	1,22	1,10				
		Double	4,82	4,38	3,99	3,65	3,35	3,09	2,85	2,65	2,46	2,29	2,14	2,01	1,88	1,77	1,67
		Multiple	5,09	4,68	4,32	4,00	3,72	3,46	3,20	2,86	2,56	2,31	2,08	1,89	1,72	1,56	1,43
	Suction	Single	4,65	4,22	3,73	3,26	2,87	2,54	2,26	2,02	1,81	1,63	1,47				
		Double	4,82	4,38	3,99	3,65	3,35	3,09	2,85	2,65	2,46	2,29	2,14	2,01	1,88	1,77	1,67
		Multiple	6,03	5,47	4,98	4,56	4,19	3,86	3,57	3,31	3,08	2,87	2,68	2,51	2,29	2,09	1,91

pressure load - deflection limit L/200
suction load - deflection limit L/150
the load shown is the ultimate load divided by 1,5

APPLIED STANDARDS / NOTES

Tolerances/Coatings	EN 10143	Steel Quality	EN 10346	Handling	European Recommendations
Tests/Calculations	EN 1990, EN 1991 1-6, EN 1993 1-3, EN 1993 1-5 (Calculations are to Eurocode, however additional checks such as fixings are required)				
Deck self weight has not been allowed for, so has to be included in applied loads					

JI 113-320-960

JI

Application:	Structural metal roof deck	Finishing:	Interior liner and Galvanised
Yield Stress (MPa):	320	Intermediate Support width:	≥160 mm
Ym:	1	End Support width:	≥40 mm

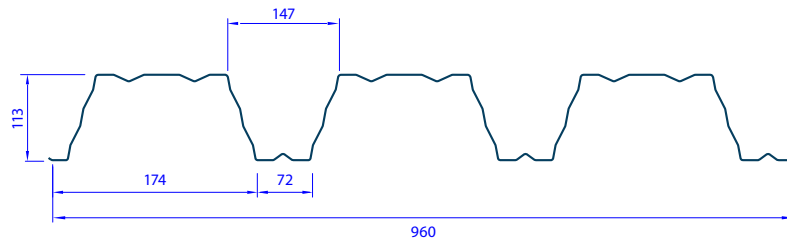

Mechanical Properties

tN [mm]	Weight (kg/m ²)	Broad flange in compression						Narrow flange in compression				
		Mc,Rk,F [kNm/m]	Mc,Rk,B [kNm/m]	I _{eff} [cm ⁴ /m]	Vw,Rk [kN/m]	Rw,Rk,B [kN/m]	Rw,Rk,A [kN/m]	Mc,Rk,F [kNm/m]	Mc,Rk,B [kNm/m]	I _{eff} [cm ⁴ /m]	Vw,Rk [kN/m]	Rw,Rk,A [kN/m]
0,75	9,20	9,74	9,64	205,11	41,56	29,60	8,81	9,64	9,74	209,88	41,56	41,56
0,88	10,79	11,95	11,63	245,30	64,83	42,56	12,81	11,63	11,95	248,24	64,83	64,83
1,00	12,27	14,27	13,39	282,87	82,96	54,30	16,49	13,39	14,27	283,64	82,96	82,96
1,25	15,33	19,31	16,87	357,32	127,48	82,39	25,44	16,87	19,31	357,32	127,48	127,48
1,50	18,40	24,08	20,35	430,92	181,04	115,11	36,04	20,35	24,08	430,92	181,04	181,04

Load type (kN/m²)

Thickness (mm)			Span (m)														
			5,00	5,20	5,40	5,60	5,80	6,00	6,20	6,40	6,60	6,80	7,00	7,20	7,40	7,60	7,80
0,75	Pressure	Single	1,32	1,18	1,05												
		Double	2,08	1,92	1,78	1,66	1,54	1,44	1,35	1,27	1,19	1,12	1,06	1,00			
		Multiple	2,08	1,92	1,78	1,66	1,54	1,45	1,31	1,19	1,09						
	Suction	Single	1,81	1,60	1,43												
		Double	2,08	1,92	1,78	1,66	1,54	1,44	1,35	1,27	1,19	1,12	1,06	1,00			
		Multiple	2,60	2,40	2,23	2,07	1,93	1,80	1,69	1,59	1,48						
0,88	Pressure	Single	1,58	1,41	1,26	1,13	1,01										
		Double	2,55	2,36	2,19	2,03	1,89	1,77	1,66	1,56	1,46	1,38	1,30	1,23	1,16	1,09	1,00
		Multiple	2,55	2,39	2,24	2,11	1,92	1,73	1,57	1,43	1,30	1,19	1,09	1,00			
	Suction	Single	2,14	1,90	1,70	1,52	1,37										
		Double	2,55	2,36	2,19	2,03	1,89	1,77	1,66	1,56	1,46	1,38	1,30	1,23	1,16	1,10	1,05
		Multiple	3,19	2,95	2,73	2,54	2,37	2,21	2,07	1,93	1,76	1,61	1,47	1,35			
1,00	Pressure	Single	1,82	1,62	1,45	1,30	1,17	1,06									
		Double	3,04	2,81	2,61	2,43	2,26	2,11	1,98	1,86	1,75	1,65	1,55	1,47	1,36	1,25	1,16
		Multiple	3,05	2,85	2,68	2,46	2,21	2,00	1,81	1,65	1,50	1,37	1,26	1,16	1,06		
	Suction	Single	2,44	2,17	1,94	1,74	1,56	1,41									
		Double	3,04	2,81	2,61	2,43	2,26	2,11	1,98	1,86	1,75	1,65	1,55	1,47	1,39	1,32	1,25
		Multiple	3,81	3,52	3,26	3,03	2,83	2,64	2,42	2,20	2,01	1,83	1,68	1,55	1,42		
1,25	Pressure	Single	2,31	2,05	1,83	1,64	1,48	1,33	1,21	1,10	1,00						
		Double	4,12	3,81	3,53	3,28	3,06	2,86	2,68	2,51	2,36	2,21	2,02	1,86	1,71	1,58	1,46
		Multiple	4,12	3,83	3,46	3,10	2,79	2,52	2,29	2,08	1,90	1,73	1,59	1,46	1,34	1,24	1,15
	Suction	Single	3,07	2,73	2,44	2,19	1,97	1,78	1,61	1,47	1,34						
		Double	4,12	3,81	3,53	3,28	3,06	2,86	2,68	2,51	2,36	2,23	2,10	1,99	1,88	1,78	1,69
		Multiple	5,15	4,76	4,41	4,11	3,72	3,36	3,05	2,77	2,53	2,31	2,12	1,95	1,79	1,66	1,53
1,50	Pressure	Single	2,78	2,47	2,21	1,98	1,78	1,61	1,46	1,33	1,21	1,11	1,01				
		Double	5,14	4,75	4,40	4,10	3,82	3,57	3,34	3,14	2,91	2,66	2,44	2,24	2,07	1,91	1,76
		Multiple	5,18	4,67	4,17	3,74	3,37	3,04	2,76	2,51	2,29	2,09	1,92	1,76	1,62	1,50	1,39
	Suction	Single	3,71	3,30	2,94	2,64	2,37	2,15	1,94	1,77	1,61	1,47	1,35				
		Double	5,14	4,75	4,40	4,10	3,82	3,57	3,34	3,14	2,95	2,78	2,62	2,48	2,35	2,22	2,11
		Multiple	6,42	5,94	5,51	4,99	4,49	4,06	3,68	3,34	3,05	2,79	2,55	2,35	2,16	2,00	1,85

pressure load - deflection limit L/200
suction load - deflection limit L/150
the load shown is the ultimate load divided by 1,5

APPLIED STANDARDS / NOTES

Tolerances/Coatings	EN 10143	Steel Quality	EN 10346	Handling	European Recommendations
Tests/Calculations	EN 1990, EN 1991 1-6, EN 1993 1-3, EN 1993 1-5 (Calculations are to Eurocode, however additional checks such as fixings are required)				
	Deck self weight has not been allowed for, so has to be included in applied loads				

JI 113-320-960 Perfo Web (R5T12,5-O)

JI

Application:	Structural metal roof deck	Finishing:	Interior liner and Galvanised
Yield Stress (MPa):	320	Intermediate Support width:	≥160 mm
Ym:	1	End Support width:	≥40 mm

■ = perforated zone

R5T12,5

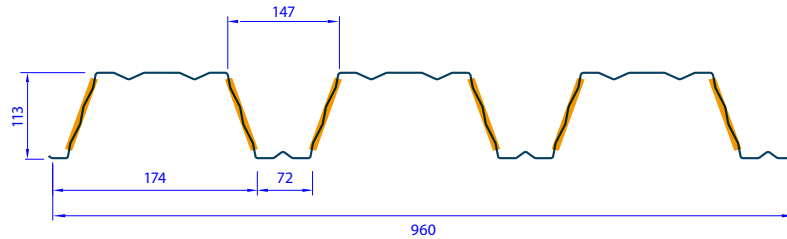

Mechanical Properties

tN [mm]	Weight (kg/m ²)	Broad flange in compression						Narrow flange in compression				
		Mc,Rk,F [kNm/m]	Mc,Rk,B [kNm/m]	I _{eff} [cm ⁴ /m]	Vw,Rk [kN/m]	Rw,Rk,B [kN/m]	Rw,Rk,A [kN/m]	Mc,Rk,F [kNm/m]	Mc,Rk,B [kNm/m]	I _{eff} [cm ⁴ /m]	Vw,Rk [kN/m]	Rw,Rk,A [kN/m]
0,75	8,62	8,82	8,42	179,43	21,46	18,34	5,46	8,42	8,82	182,97	21,46	21,46
0,88	10,11	10,84	10,19	209,69	33,81	26,36	7,93	10,19	10,84	216,46	33,81	33,81
1,00	11,50	12,97	11,64	237,11	48,60	33,62	10,21	11,64	12,97	247,38	48,60	48,60
1,25	14,36	17,29	14,67	297,88	77,12	50,96	15,73	14,67	17,29	311,76	77,12	77,12
1,50	17,24	21,64	17,71	359,39	109,76	71,13	22,27	17,71	21,64	376,17	109,76	109,76

Load type (kN/m²)

Thickness (mm)			Span (m)														
			5,00	5,20	5,40	5,60	5,80	6,00	6,20	6,40	6,60	6,80	7,00	7,20	7,40	7,60	7,80
0,75	Pressure	Single	1,16	1,03	0,92	0,82	0,74	0,67	0,61	0,55	0,50	0,46	0,42	0,39	0,36	0,33	0,30
		Double	1,46	1,40	1,35	1,30	1,26	1,21	1,17	1,12	1,06	1,01	0,96	0,91	0,86	0,79	0,73
		Multiple	1,46	1,40	1,35	1,30	1,26	1,21	1,15	1,04	0,95	0,87	0,80	0,73	0,68	0,62	0,58
	Suction	Single	1,57	1,40	1,25	1,12	1,01	0,91	0,83	0,75	0,68	0,63	0,57	0,53	0,49	0,45	0,41
		Double	1,88	1,74	1,61	1,50	1,40	1,31	1,22	1,15	1,08	1,02	0,96	0,91	0,86	0,81	0,77
		Multiple	2,35	2,17	2,02	1,88	1,75	1,63	1,53	1,42	1,29	1,18	1,08	1,00	0,92	0,85	0,78
0,88	Pressure	Single	1,35	1,20	1,07	0,96	0,87	0,78	0,71	0,65	0,59	0,54	0,49	0,45	0,42	0,39	0,36
		Double	2,11	2,03	1,91	1,81	1,71	1,61	1,50	1,41	1,33	1,25	1,18	1,09	1,01	0,93	0,86
		Multiple	2,11	2,03	1,96	1,82	1,64	1,48	1,34	1,22	1,11	1,02	0,93	0,86	0,79	0,73	0,67
	Suction	Single	1,86	1,66	1,48	1,33	1,19	1,08	0,98	0,89	0,81	0,74	0,68	0,62	0,57	0,53	0,49
		Double	2,31	2,14	1,98	1,84	1,72	1,61	1,50	1,41	1,33	1,25	1,18	1,12	1,06	1,00	0,95
		Multiple	2,89	2,67	2,48	2,30	2,15	2,01	1,85	1,68	1,53	1,40	1,28	1,18	1,09	1,00	0,93
1,00	Pressure	Single	1,53	1,36	1,21	1,09	0,98	0,89	0,80	0,73	0,67	0,61	0,56	0,51	0,47	0,44	0,40
		Double	2,60	2,44	2,29	2,16	2,04	1,92	1,80	1,69	1,59	1,46	1,34	1,23	1,14	1,05	0,97
		Multiple	2,72	2,56	2,30	2,06	1,85	1,67	1,52	1,38	1,26	1,15	1,05	0,97	0,89	0,82	0,76
	Suction	Single	2,13	1,89	1,69	1,51	1,36	1,23	1,12	1,01	0,93	0,85	0,78	0,71	0,66	0,61	0,56
		Double	2,77	2,56	2,37	2,21	2,06	1,92	1,80	1,69	1,59	1,50	1,41	1,33	1,26	1,20	1,14
		Multiple	3,46	3,20	2,97	2,76	2,57	2,33	2,11	1,92	1,75	1,60	1,47	1,35	1,24	1,15	1,06
1,25	Pressure	Single	1,92	1,71	1,53	1,37	1,23	1,11	1,01	0,92	0,84	0,76	0,70	0,64	0,59	0,55	0,51
		Double	3,53	3,30	3,10	2,92	2,74	2,56	2,40	2,21	2,01	1,84	1,69	1,55	1,43	1,32	1,22
		Multiple	3,63	3,23	2,89	2,59	2,33	2,10	1,91	1,73	1,58	1,44	1,32	1,22	1,12	1,04	0,96
	Suction	Single	2,68	2,38	2,13	1,91	1,72	1,55	1,41	1,28	1,17	1,07	0,98	0,90	0,83	0,76	0,71
		Double	3,69	3,41	3,16	2,94	2,74	2,56	2,40	2,25	2,12	1,99	1,88	1,78	1,68	1,60	1,52
		Multiple	4,61	4,26	3,95	3,61	3,25	2,94	2,66	2,42	2,21	2,02	1,85	1,70	1,56	1,44	1,34
1,50	Pressure	Single	2,32	2,06	1,84	1,65	1,49	1,34	1,22	1,11	1,01	0,92	0,84	0,78	0,72	0,66	0,61
		Double	4,49	4,20	3,94	3,68	3,43	3,21	2,93	2,66	2,43	2,22	2,04	1,87	1,72	1,59	1,47
		Multiple	4,39	3,90	3,48	3,12	2,81	2,54	2,30	2,09	1,91	1,74	1,60	1,47	1,35	1,25	1,16
	Suction	Single	3,24	2,88	2,57	2,30	2,07	1,87	1,70	1,54	1,41	1,29	1,18	1,08	1,00	0,92	0,85
		Double	4,62	4,27	3,96	3,68	3,43	3,21	3,00	2,82	2,65	2,50	2,36	2,23	2,11	2,00	1,90
		Multiple	5,77	5,34	4,86	4,36	3,92	3,54	3,21	2,92	2,66	2,43	2,23	2,05	1,89	1,74	1,61

pressure load - deflection limit L/200
suction load - deflection limit L/150
the load shown is the ultimate load divided by 1,5

APPLIED STANDARDS / NOTES

Tolerances/Coatings	EN 10143	Steel Quality	EN 10346	Handling	European Recommendations
Tests/Calculations	EN 1990, EN 1991 1-6, EN 1993 1-3, EN 1993 1-5 (Calculations are to Eurocode, however additional checks such as fixings are required)				
Deck self weight has not been allowed for, so has to be included in applied loads					

JI 137-310-930

JI

Application:	Structural metal roof deck	Finishing:	Interior liner and Galvanised
Yield Stress (MPa):	320	Intermediate Support width:	≥160 mm
Ym:	1	End Support width:	≥40 mm

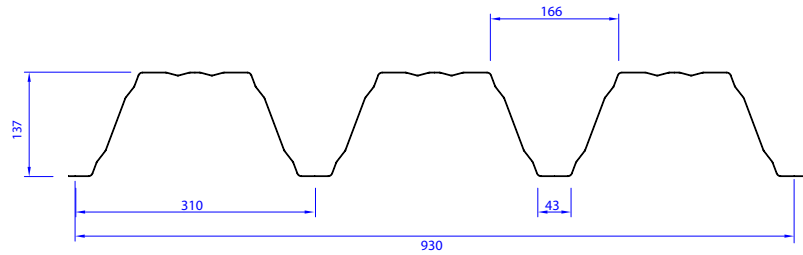

Mechanical Properties

tN [mm]	Weight (kg/m ²)	Broad flange in compression						Narrow flange in compression				
		Mc,Rk,F [kNm/m]	Mc,Rk,B [kNm/m]	I _{eff} [cm ⁴ /m]	Vw,Rk [kN/m]	Rw,Rk,B [kN/m]	Rw,Rk,A [kN/m]	Mc,Rk,F [kNm/m]	Mc,Rk,B [kNm/m]	I _{eff} [cm ⁴ /m]	Vw,Rk [kN/m]	Rw,Rk,A [kN/m]
0,75	9,70	9,69	8,30	278,22	31,18	27,89	8,30	8,30	9,69	276,33	31,18	31,18
0,88	11,40	12,29	10,90	336,41	49,74	38,58	11,61	10,90	12,29	335,62	49,74	49,74
1,00	12,90	14,81	13,43	386,57	72,15	49,68	15,09	13,43	14,81	386,57	72,15	72,15
1,25	16,10	20,28	18,55	487,04	132,61	76,42	23,60	18,55	20,28	487,04	132,61	132,61
1,50	19,40	26,18	22,54	587,43	189,62	107,76	33,74	22,54	26,18	587,43	189,62	189,62

Load type (kN/m²)

Thickness (mm)			Span (m)														
			4,60	4,80	5,00	5,20	5,40	5,60	5,80	6,00	6,20	6,40	6,60	6,80	7,00	7,20	7,40
0,75	Pressure	Single	2,30	2,03	1,79	1,60	1,42	1,28	1,15								
		Double	2,26	2,11	1,97	1,85	1,73	1,63	1,54	1,44	1,34	1,26	1,19	1,12			
		Multiple	2,41	2,24	2,07	1,91	1,77	1,65	1,54	1,44	1,34	1,26	1,19	1,12			
	Suction	Single	2,09	1,92	1,77	1,64	1,52	1,41	1,32								
		Double	2,44	2,24	2,07	1,91	1,77	1,65	1,54	1,44	1,34	1,26	1,19	1,12			
		Multiple	3,05	2,80	2,58	2,39	2,22	2,06	1,92	1,79	1,68	1,58	1,48	1,40			
0,88	Pressure	Single	2,79	2,45	2,17	1,93	1,72	1,54	1,39	1,26	1,14						
		Double	3,03	2,83	2,62	2,42	2,25	2,09	1,95	1,82	1,71	1,60	1,50	1,42	1,34	1,26	1,20
		Multiple	3,10	2,84	2,62	2,42	2,25	2,09	1,95	1,82	1,71	1,60	1,50	1,42	1,34	1,27	1,21
	Suction	Single	2,75	2,52	2,33	2,15	1,99	1,85	1,73	1,61	1,51						
		Double	3,10	2,84	2,62	2,42	2,25	2,09	1,95	1,82	1,71	1,60	1,50	1,42	1,34	1,26	1,20
		Multiple	3,87	3,56	3,28	3,03	2,81	2,61	2,44	2,28	2,13	2,00	1,88	1,77	1,67	1,58	1,50
1,00	Pressure	Single	3,20	2,82	2,49	2,22	1,98	1,78	1,60	1,44	1,31	1,19					
		Double	3,73	3,43	3,16	2,92	2,71	2,52	2,35	2,19	2,05	1,93	1,81	1,71	1,61	1,52	1,44
		Multiple	3,73	3,43	3,16	2,92	2,71	2,52	2,35	2,19	2,06	1,95	1,85	1,75	1,67	1,58	1,46
	Suction	Single	3,39	3,11	2,87	2,65	2,46	2,28	2,13	1,92	1,74	1,59					
		Double	3,73	3,43	3,16	2,92	2,71	2,52	2,35	2,19	2,05	1,93	1,81	1,71	1,61	1,52	1,44
		Multiple	4,67	4,29	3,95	3,65	3,39	3,15	2,93	2,74	2,57	2,41	2,27	2,14	2,01	1,90	1,80
1,25	Pressure	Single	4,03	3,55	3,14	2,79	2,49	2,24	2,01	1,82	1,65	1,50	1,37	1,25	1,15		
		Double	5,11	4,69	4,33	4,00	3,71	3,45	3,22	3,00	2,81	2,64	2,48	2,34	2,21	2,09	1,98
		Multiple	5,11	4,69	4,33	4,00	3,73	3,50	3,30	3,11	2,94	2,78	2,58	2,36	2,21	2,09	1,98
	Suction	Single	4,68	4,29	3,96	3,66	3,33	2,98	2,68	2,42	2,20	2,00	1,82	1,67	1,53		
		Double	5,11	4,69	4,33	4,00	3,71	3,45	3,22	3,00	2,81	2,64	2,48	2,34	2,21	2,09	1,98
		Multiple	6,39	5,87	5,41	5,00	4,64	4,31	4,02	3,76	3,52	3,30	3,10	2,92	2,76	2,61	2,44
1,50	Pressure	Single	4,87	4,28	3,79	3,37	3,01	2,70	2,43	2,19	1,99	1,81	1,65	1,51	1,38	1,27	1,17
		Double	6,60	6,06	5,59	5,16	4,79	4,45	4,15	3,88	3,63	3,41	3,21	3,02	2,85	2,69	2,55
		Multiple	6,60	6,06	5,59	5,16	4,79	4,47	4,20	3,96	3,74	3,42	3,12	2,85	2,61	2,40	2,21
	Suction	Single	5,68	5,22	4,81	4,45	4,01	3,60	3,24	2,92	2,65	2,41	2,20	2,01	1,84	1,69	1,56
		Double	6,60	6,06	5,59	5,16	4,79	4,45	4,15	3,88	3,63	3,41	3,21	3,02	2,85	2,69	2,55
		Multiple	8,25	7,58	6,98	6,45	5,99	5,57	5,19	4,85	4,54	4,26	4,01	3,77	3,48	3,20	2,95

pressure load - deflection limit L/200
suction load - deflection limit L/150
the load shown is the ultimate load divided by 1,5

APPLIED STANDARDS / NOTES

Tolerances/Coatings	EN 10143	Steel Quality	EN 10346	Handling	European Recommendations
Tests/Calculations	EN 1990, EN 1991 1-6, EN 1993 1-3, EN 1993 1-5 (Calculations are to Eurocode, however additional checks such as fixings are required)				
	Deck self weight has not been allowed for, so has to be included in applied loads				

JI 137-310-930 Perfo Web (R5T12,5-DO)

JI

Application:	Structural metal roof deck	Finishing:	Interior liner and Galvanised
Yield Stress (MPa):	320	Intermediate Support width:	≥160 mm
Ym:	1	End Support width:	≥40 mm

■ = perforated zone

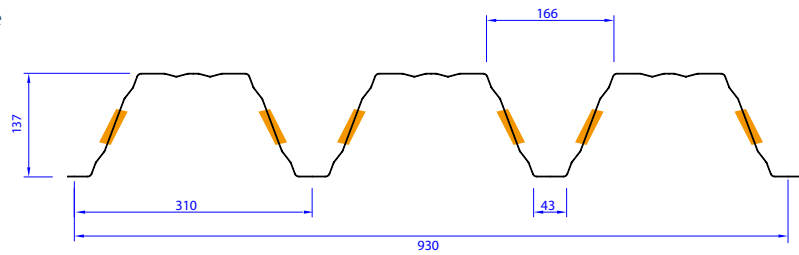

R5T12,5



Mechanical Properties

tN [mm]	Weight (kg/m ²)	Broad flange in compression						Narrow flange in compression				
		Mc,Rk,F [kNm/m]	Mc,Rk,B [kNm/m]	I _{eff} [cm ⁴ /m]	Vw,Rk [kN/m]	Rw,Rk.B [kN/m]	Rw,Rk.A [kN/m]	Mc,Rk,F [kNm/m]	Mc,Rk,B [kNm/m]	I _{eff} [cm ⁴ /m]	Vw,Rk [kN/m]	Rw,Rk.A [kN/m]
0,75	9,70	9,58	8,14	273,84	21,72	23,44	6,93	8,14	9,58	267,97	21,72	21,72
0,88	11,40	12,17	10,61	330,99	34,69	32,46	9,71	10,61	12,17	328,82	34,69	34,69
1,00	12,90	14,67	13,07	380,31	50,38	41,84	12,62	13,07	14,67	378,90	50,38	50,38
1,25	16,10	20,10	17,86	479,15	96,46	64,42	19,75	17,86	20,10	477,37	96,46	96,46
1,50	19,40	25,74	21,72	577,91	151,05	90,89	28,25	21,72	25,74	575,76	151,05	151,05

Load type (kN/m²)

Thickness (mm)			Span (m)														
			4,00	4,20	4,40	4,60	4,80	5,00	5,20	5,40	5,60	5,80	6,00	6,20	6,40	6,60	6,80
0,75	Pressure	Single	2,31	2,20	2,10	2,01	1,92	1,77	1,57	1,40	1,26	1,13					
		Double	2,31	2,20	2,10	2,01	1,92	1,81	1,70	1,60	1,51	1,42	1,35	1,27	1,21	1,15	
		Multiple	2,31	2,20	2,10	2,01	1,92	1,85	1,78	1,71	1,63	1,52	1,42	1,33	1,25	1,17	1,10
	Suction	Single	2,71	2,46	2,24	2,05	1,88	1,74	1,61	1,49	1,38	1,29					
		Double	3,17	2,89	2,64	2,41	2,22	2,04	1,89	1,75	1,63	1,52	1,42	1,33	1,25	1,17	
		Multiple	3,75	3,47	3,21	2,97	2,75	2,55	2,36	2,19	2,04	1,90	1,77	1,66	1,56	1,47	1,38
0,88	Pressure	Single	3,24	3,08	2,94	2,74	2,41	2,14	1,90	1,70	1,52	1,37	1,24	1,12			
		Double	3,24	3,08	2,94	2,78	2,59	2,43	2,27	2,14	2,01	1,90	1,79	1,69	1,58	1,49	1,40
		Multiple	3,24	3,08	2,94	2,81	2,70	2,59	2,40	2,23	2,07	1,93	1,80	1,69	1,58	1,49	1,40
	Suction	Single	3,54	3,21	2,92	2,67	2,46	2,26	2,09	1,94	1,80	1,68	1,57	1,47			
		Double	4,06	3,68	3,35	3,07	2,82	2,60	2,40	2,23	2,07	1,93	1,80	1,69	1,58	1,49	1,40
		Multiple	5,06	4,60	4,19	3,83	3,52	3,25	3,00	2,78	2,59	2,41	2,25	2,11	1,98	1,86	1,75
1,00	Pressure	Single	4,21	4,01	3,60	3,15	2,77	2,45	2,18	1,95	1,75	1,57	1,42	1,29	1,17		
		Double	4,21	4,01	3,75	3,49	3,25	3,04	2,85	2,68	2,49	2,33	2,17	2,04	1,91	1,80	1,69
		Multiple	4,21	4,01	3,82	3,66	3,40	3,13	2,89	2,68	2,49	2,33	2,17	2,04	1,91	1,80	1,69
	Suction	Single	4,36	3,95	3,60	3,29	3,03	2,79	2,58	2,39	2,22	2,07	1,89	1,71	1,55		
		Double	4,89	4,44	4,04	3,70	3,40	3,13	2,89	2,68	2,49	2,33	2,17	2,04	1,91	1,80	1,69
		Multiple	6,11	5,54	5,05	4,62	4,24	3,91	3,62	3,35	3,12	2,91	2,72	2,54	2,39	2,25	2,12
1,25	Pressure	Single	6,04	5,22	4,54	3,97	3,49	3,09	2,75	2,45	2,20	1,98	1,79	1,62	1,47	1,34	1,23
		Double	6,30	5,82	5,39	5,01	4,65	4,29	3,96	3,68	3,42	3,19	2,98	2,79	2,62	2,46	2,32
		Multiple	6,58	6,08	5,54	5,07	4,65	4,29	3,96	3,68	3,42	3,19	2,98	2,79	2,62	2,46	2,32
	Suction	Single	5,95	5,40	4,92	4,50	4,13	3,81	3,52	3,26	2,92	2,63	2,38	2,15	1,96	1,79	1,63
		Double	6,70	6,08	5,54	5,07	4,65	4,29	3,96	3,68	3,42	3,19	2,98	2,79	2,62	2,46	2,32
		Multiple	8,38	7,60	6,92	6,33	5,82	5,36	4,96	4,60	4,27	3,98	3,72	3,49	3,27	3,08	2,90
1,50	Pressure	Single	7,28	6,29	5,47	4,79	4,21	3,73	3,31	2,96	2,65	2,39	2,16	1,96	1,78	1,62	1,48
		Double	8,15	7,51	6,95	6,44	5,96	5,49	5,08	4,71	4,38	4,08	3,81	3,57	3,35	3,15	2,97
		Multiple	8,58	7,78	7,09	6,49	5,96	5,49	5,08	4,71	4,38	4,08	3,81	3,57	3,35	3,15	2,80
	Suction	Single	7,24	6,57	5,98	5,47	5,03	4,63	4,28	3,93	3,53	3,17	2,87	2,60	2,36	2,15	1,97
		Double	8,58	7,78	7,09	6,49	5,96	5,49	5,08	4,71	4,38	4,08	3,81	3,57	3,35	3,15	2,97
		Multiple	10,73	9,73	8,86	8,11	7,45	6,86	6,35	5,88	5,47	5,10	4,77	4,46	4,19	3,94	3,71

pressure load - deflection limit L/200
suction load - deflection limit L/150
the load shown is the ultimate load divided by 1,5

APPLIED STANDARDS / NOTES

Tolerances/Coatings	EN 10143	Steel Quality	EN 10346	Handling	European Recommendations
Tests/Calculations	EN 1990, EN 1991 1-6, EN 1993 1-3, EN 1993 1-5 (Calculations are to Eurocode, however additional checks such as fixings are required)				
Deck self weight has not been allowed for, so has to be included in applied loads					

JI 153-280-840

JI

Application:	Structural metal roof deck	Finishing:	Interior liner and Galvanised
Yield Stress (MPa):	320	Intermediate Support width:	≥160 mm
Ym:	1	End Support width:	≥40 mm

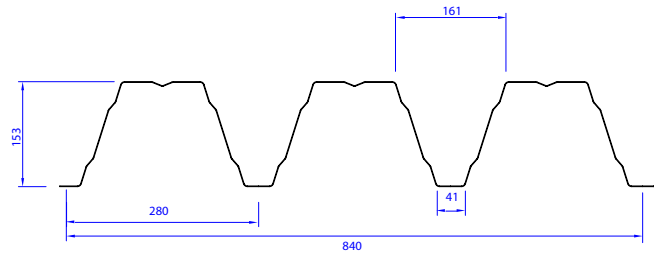

Mechanical Properties

tN [mm]	Weight (kg/m ²)	Broad flange in compression						Narrow flange in compression				
		Mc,Rk,F [kNm/m]	Mc,Rk,B [kNm/m]	I _{eff} [cm ⁴ /m]	Vw,Rk [kN/m]	Rw,Rk,B [kN/m]	Rw,Rk,A [kN/m]	Mc,Rk,F [kNm/m]	Mc,Rk,B [kNm/m]	I _{eff} [cm ⁴ /m]	Vw,Rk [kN/m]	Rw,Rk,A [kN/m]
0,75	10,51	12,86	10,84	358,66	31,55	32,01	9,53	10,84	12,86	366,39	31,55	31,55
0,88	12,33	16,17	13,84	436,35	50,67	44,11	13,28	13,84	16,17	443,82	50,67	50,67
1,00	14,01	19,26	17,03	507,07	73,52	56,67	17,21	17,03	19,26	507,11	73,52	73,52
1,25	17,52	25,80	23,02	638,83	140,53	86,86	26,82	23,02	25,80	638,88	140,53	140,53
1,50	21,02	32,21	27,76	770,46	210,90	122,22	38,27	27,76	32,21	770,53	210,90	210,90

Load type (kN/m²)

Thickness (mm)			Span (m)														
			5,40	5,60	5,80	6,00	6,20	6,40	6,60	6,80	7,00	7,20	7,40	7,60	7,80	8,00	8,20
0,75	Pressure	Single	1,84	1,65	1,48	1,34	1,21	1,10									
		Double	2,15	2,03	1,91	1,81	1,71	1,62	1,54	1,47	1,39	1,32	1,25	1,19	1,13		
		Multiple	2,35	2,19	2,04	1,91	1,78	1,68	1,58	1,48	1,40	1,32	1,25	1,19	1,13		
	Suction	Single	1,98	1,84	1,72	1,61	1,50	1,41									
		Double	2,35	2,19	2,04	1,91	1,78	1,68	1,58	1,48	1,40	1,32	1,25	1,19	1,13		
		Multiple	2,94	2,73	2,55	2,38	2,23	2,09	1,97	1,85	1,75	1,65	1,57	1,48	1,41		
0,88	Pressure	Single	2,23	2,00	1,80	1,63	1,48	1,34	1,22	1,12							
		Double	2,83	2,67	2,51	2,38	2,24	2,10	1,98	1,86	1,76	1,66	1,57	1,49	1,42	1,35	1,28
		Multiple	2,96	2,75	2,56	2,39	2,24	2,10	1,98	1,86	1,76	1,66	1,57	1,49	1,40	1,30	1,21
	Suction	Single	2,53	2,35	2,19	2,05	1,92	1,80	1,66	1,52							
		Double	2,96	2,75	2,56	2,39	2,24	2,10	1,98	1,86	1,76	1,66	1,57	1,49	1,42	1,35	1,28
		Multiple	3,70	3,44	3,20	2,99	2,80	2,63	2,47	2,33	2,20	2,08	1,97	1,87	1,77	1,68	1,60
1,00	Pressure	Single	2,60	2,33	2,10	1,89	1,72	1,56	1,42	1,30	1,19	1,10					
		Double	3,52	3,28	3,05	2,85	2,67	2,51	2,36	2,22	2,10	1,98	1,88	1,78	1,69	1,61	1,53
		Multiple	3,52	3,28	3,05	2,85	2,67	2,51	2,36	2,22	2,10	1,98	1,88	1,78	1,69	1,61	1,53
	Suction	Single	3,12	2,90	2,70	2,52	2,29	2,08	1,90	1,73	1,59	1,46					
		Double	3,52	3,28	3,05	2,85	2,67	2,51	2,36	2,22	2,10	1,98	1,88	1,78	1,69	1,61	1,53
		Multiple	4,40	4,10	3,82	3,57	3,34	3,14	2,95	2,78	2,62	2,48	2,35	2,22	2,11	2,01	1,87
1,25	Pressure	Single	3,27	2,93	2,64	2,38	2,16	1,97	1,79	1,64	1,50	1,38	1,27	1,17			
		Double	4,72	4,39	4,09	3,82	3,58	3,36	3,16	2,98	2,81	2,65	2,51	2,38	2,26	2,15	2,05
		Multiple	4,72	4,39	4,09	3,82	3,58	3,36	3,19	3,03	2,84	2,61	2,40	2,22	2,05	1,90	1,77
	Suction	Single	4,21	3,91	3,52	3,18	2,88	2,62	2,39	2,18	2,00	1,84	1,70	1,56			
		Double	4,72	4,39	4,09	3,82	3,58	3,36	3,16	2,98	2,81	2,65	2,51	2,38	2,26	2,15	2,05
		Multiple	5,90	5,49	5,11	4,78	4,48	4,20	3,95	3,72	3,51	3,32	3,14	2,96	2,74	2,54	2,36
1,50	Pressure	Single	3,95	3,54	3,18	2,88	2,61	2,37	2,16	1,98	1,81	1,66	1,53	1,42	1,31	1,21	1,13
		Double	5,89	5,48	5,11	4,77	4,47	4,19	3,94	3,72	3,51	3,31	3,14	2,97	2,82	2,68	2,55
		Multiple	5,89	5,48	5,11	4,77	4,49	4,25	4,03	3,74	3,43	3,15	2,90	2,68	2,48	2,30	2,13
	Suction	Single	5,08	4,72	4,25	3,84	3,48	3,16	2,88	2,63	2,42	2,22	2,04	1,89	1,75	1,62	1,50
		Double	5,89	5,48	5,11	4,77	4,47	4,19	3,94	3,72	3,51	3,31	3,14	2,97	2,82	2,68	2,55
		Multiple	7,36	6,85	6,38	5,96	5,59	5,24	4,93	4,64	4,38	4,14	3,87	3,57	3,30	3,06	2,84

pressure load - deflection limit L/200
suction load - deflection limit L/150
the load shown is the ultimate load divided by 1,5

APPLIED STANDARDS / NOTES

Tolerances/Coatings	EN 10143	Steel Quality	EN 10346	Handling	European Recommendations
Tests/Calculations	EN 1990, EN 1991 1-6, EN 1993 1-3, EN 1993 1-5 (Calculations are to Eurocode, however additional checks such as fixings are required)				
	Deck self weight has not been allowed for, so has to be included in applied loads				

JI 153-280-840 Perfo Web (R5T12,5-DO)

JI

Application:	Structural metal roof deck	Finishing:	Interior liner and Galvanised
Yield Stress (MPa):	320	Intermediate Support width:	≥160 mm
Ym:	1	End Support width:	≥40 mm

■ = perforated zone

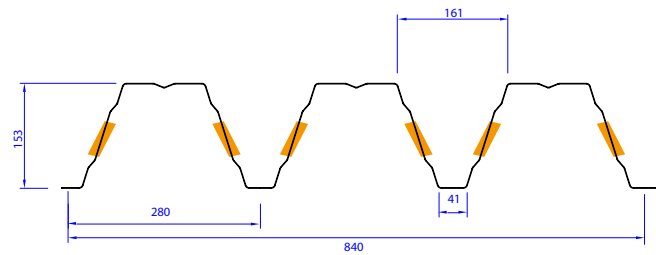

R5T12,5



Mechanical Properties

tN [mm]	Weight (kg/m ²)	Broad flange in compression						Narrow flange in compression				
		Mc,Rk,F [kNm/m]	Mc,Rk,B [kNm/m]	I _{eff} [cm ⁴ /m]	Vw,Rk [kN/m]	Rw,Rk,B [kN/m]	Rw,Rk,A [kN/m]	Mc,Rk,F [kNm/m]	Mc,Rk,B [kNm/m]	I _{eff} [cm ⁴ /m]	Vw,Rk [kN/m]	Rw,Rk,A [kN/m]
0,75	10,51	12,76	10,53	354,73	22,13	27,32	8,09	10,53	12,76	360,77	22,13	22,13
0,88	12,33	16,06	13,64	431,48	35,56	37,70	11,28	13,64	16,06	437,76	35,56	35,56
1,00	14,01	19,09	16,74	501,33	51,67	48,47	14,63	16,74	19,09	500,18	51,67	51,67
1,25	17,52	25,57	22,42	631,59	99,00	74,36	22,81	22,42	25,57	630,14	99,00	99,00
1,50	21,02	31,91	27,03	761,73	168,17	104,68	32,56	27,03	31,91	759,98	168,17	168,17

Load type (kN/m²)

Thickness (mm)			Span (m)														
			5,00	5,20	5,40	5,60	5,80	6,00	6,20	6,40	6,60	6,80	7,00	7,20	7,40	7,60	7,80
0,75	Pressure	Single	2,16	2,03	1,82	1,63	1,47	1,32	1,20								
		Double	2,16	2,07	1,98	1,87	1,77	1,67	1,58	1,50	1,43	1,36	1,29	1,24	1,18	1,13	
		Multiple	2,16	2,07	2,00	1,93	1,86	1,80	1,74	1,66	1,56	1,47	1,39	1,31	1,24	1,18	1,12
	Suction	Single	2,25	2,08	1,93	1,79	1,67	1,56	1,46								
		Double	2,67	2,49	2,32	2,17	2,02	1,89	1,77	1,66	1,56	1,47	1,39	1,31	1,24	1,18	
		Multiple	3,14	2,95	2,78	2,61	2,46	2,32	2,19	2,07	1,95	1,84	1,74	1,64	1,55	1,47	1,40
0,88	Pressure	Single	2,78	2,47	2,21	1,98	1,78	1,61	1,46	1,33	1,21	1,11					
		Double	2,99	2,80	2,64	2,48	2,35	2,22	2,10	1,99	1,89	1,80	1,72	1,64	1,56	1,48	1,41
		Multiple	3,01	2,89	2,79	2,69	2,55	2,38	2,23	2,09	1,97	1,85	1,75	1,65	1,56	1,48	1,39
	Suction	Single	2,91	2,69	2,49	2,32	2,16	2,02	1,89	1,78	1,64	1,50					
		Double	3,43	3,17	2,94	2,73	2,55	2,38	2,23	2,09	1,97	1,85	1,75	1,65	1,56	1,48	1,41
		Multiple	4,26	3,95	3,67	3,41	3,18	2,97	2,78	2,61	2,46	2,31	2,18	2,06	1,95	1,85	1,76
1,00	Pressure	Single	3,23	2,88	2,57	2,30	2,07	1,87	1,70	1,54	1,41	1,29	1,18				
		Double	3,74	3,51	3,30	3,11	2,93	2,77	2,62	2,49	2,34	2,20	2,08	1,96	1,86	1,76	1,67
		Multiple	3,90	3,75	3,49	3,25	3,03	2,83	2,65	2,49	2,34	2,20	2,08	1,96	1,86	1,74	1,61
	Suction	Single	3,57	3,30	3,06	2,85	2,65	2,48	2,26	2,05	1,87	1,71	1,57				
		Double	4,07	3,76	3,49	3,25	3,03	2,83	2,65	2,49	2,34	2,20	2,08	1,96	1,86	1,76	1,67
		Multiple	5,09	4,71	4,36	4,06	3,78	3,53	3,31	3,11	2,92	2,75	2,60	2,45	2,32	2,20	2,09
1,25	Pressure	Single	4,07	3,62	3,23	2,90	2,61	2,36	2,14	1,94	1,77	1,62	1,48	1,36	1,26	1,16	
		Double	5,30	4,96	4,66	4,35	4,05	3,79	3,55	3,33	3,13	2,95	2,78	2,63	2,49	2,36	2,24
		Multiple	5,46	5,04	4,68	4,35	4,05	3,79	3,55	3,33	3,13	2,95	2,78	2,58	2,38	2,19	2,03
	Suction	Single	4,78	4,42	4,10	3,81	3,47	3,14	2,84	2,58	2,36	2,15	1,98	1,82	1,67	1,54	
		Double	5,46	5,04	4,68	4,35	4,05	3,79	3,55	3,33	3,13	2,95	2,78	2,63	2,49	2,36	2,24
		Multiple	6,82	6,30	5,85	5,44	5,07	4,74	4,43	4,16	3,91	3,69	3,48	3,29	3,11	2,92	2,70
1,50	Pressure	Single	4,91	4,37	3,90	3,50	3,15	2,84	2,58	2,34	2,14	1,95	1,79	1,65	1,52	1,40	1,29
		Double	6,77	6,29	5,84	5,43	5,06	4,73	4,43	4,15	3,91	3,68	3,47	3,28	3,11	2,95	2,80
		Multiple	6,81	6,29	5,84	5,43	5,06	4,73	4,43	4,15	3,91	3,68	3,39	3,11	2,87	2,65	2,45
	Suction	Single	5,77	5,33	4,94	4,60	4,19	3,78	3,43	3,12	2,84	2,60	2,38	2,19	2,02	1,86	1,72
		Double	6,81	6,29	5,84	5,43	5,06	4,73	4,43	4,15	3,91	3,68	3,47	3,28	3,11	2,95	2,80
		Multiple	8,51	7,87	7,30	6,78	6,32	5,91	5,53	5,19	4,88	4,60	4,34	4,10	3,81	3,52	3,26

pressure load - deflection limit L/200
suction load - deflection limit L/150
the load shown is the ultimate load divided by 1,5

APPLIED STANDARDS / NOTES

Tolerances/Coatings	EN 10143	Steel Quality	EN 10346	Handling	European Recommendations
Tests/Calculations	EN 1990, EN 1991 1-6, EN 1993 1-3, EN 1993 1-5 (Calculations are to Eurocode, however additional checks such as fixings are required)				
Deck self weight has not been allowed for, so has to be included in applied loads					

JI 158-250-750

JI

Application:	Structural metal roof deck	Finishing:	Interior liner and Galvanised
Yield Stress (MPa):	320	Intermediate Support width:	≥160 mm
Ym:	1	End Support width:	≥40 mm

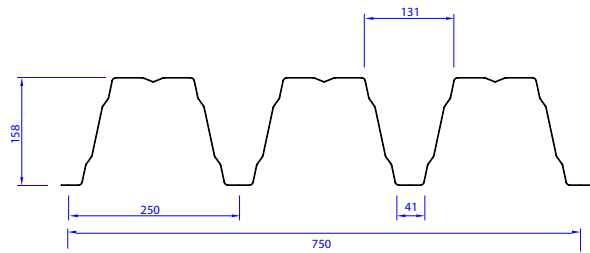

Mechanical Properties

tN [mm]	Weight (kg/m ²)	Broad flange in compression						Narrow flange in compression					
		Mc,Rk,F [kNm/m]	Mc,Rk,B [kNm/m]	I _{eff} [cm ⁴ /m]	Vw,Rk [kN/m]	Rw,Rk,B [kN/m]	Rw,Rk,A [kN/m]	Mc,Rk,F [kNm/m]	Mc,Rk,B [kNm/m]	I _{eff} [cm ⁴ /m]	Vw,Rk [kN/m]	Rw,Rk,A [kN/m]	
0,75	11,78	14,80	12,42	426,95	35,45	36,93	10,99	12,42	14,80	436,44	35,45	35,45	
0,88	13,82	18,60	15,89	519,38	56,82	50,92	15,32	15,89	18,60	527,79	56,82	56,82	
1,00	15,71	22,24	19,55	603,02	82,45	65,43	19,87	19,55	22,24	603,01	82,45	82,45	
1,25	19,63	29,78	26,49	759,61	157,60	100,32	30,98	26,49	29,78	759,60	157,60	157,60	
1,50	23,56	37,14	31,94	916,01	236,01	141,20	44,21	31,94	37,14	916,01	236,01	236,01	

Load type (kN/m²)

Thickness (mm)			Span (m)															
			6,00	6,20	6,40	6,60	6,80	7,00	7,20	7,40	7,60	7,80	8,00	8,20	8,40	8,60	8,80	
0,75	Pressure	Single	1,59	1,44	1,31	1,20												
		Double	2,08	1,97	1,86	1,77	1,68	1,60	1,52	1,44	1,37	1,30	1,23	1,17	1,12			
		Multiple	2,19	2,05	1,93	1,81	1,71	1,61	1,52	1,44	1,37	1,30	1,23	1,17	1,10			
	Suction	Single	1,84	1,72	1,62	1,52												
		Double	2,19	2,05	1,93	1,81	1,71	1,61	1,52	1,44	1,37	1,30	1,23	1,17	1,12			
		Multiple	2,74	2,57	2,41	2,27	2,13	2,01	1,90	1,80	1,71	1,62	1,54	1,47	1,40			
0,88	Pressure	Single	1,94	1,76	1,60	1,46	1,33	1,22	1,12									
		Double	2,73	2,58	2,42	2,28	2,15	2,02	1,91	1,81	1,72	1,63	1,55	1,48	1,41	1,34	1,28	
		Multiple	2,76	2,58	2,42	2,28	2,15	2,02	1,91	1,81	1,72	1,63	1,55	1,44	1,34	1,25	1,16	
	Suction	Single	2,35	2,20	2,07	1,95	1,80	1,65	1,52									
		Double	2,76	2,58	2,42	2,28	2,15	2,02	1,91	1,81	1,72	1,63	1,55	1,48	1,41	1,34	1,28	
		Multiple	3,44	3,23	3,03	2,85	2,68	2,53	2,39	2,26	2,15	2,04	1,94	1,84	1,76	1,68	1,58	
1,00	Pressure	Single	2,25	2,04	1,85	1,69	1,55	1,42	1,30	1,20	1,11							
		Double	3,29	3,09	2,90	2,72	2,57	2,42	2,29	2,17	2,05	1,95	1,85	1,76	1,68	1,60	1,53	
		Multiple	3,29	3,09	2,90	2,72	2,57	2,42	2,29	2,17	2,05	1,94	1,80	1,67	1,55	1,45	1,35	
	Suction	Single	2,90	2,71	2,47	2,26	2,06	1,89	1,74	1,60	1,48							
		Double	3,29	3,09	2,90	2,72	2,57	2,42	2,29	2,17	2,05	1,95	1,85	1,76	1,68	1,60	1,53	
		Multiple	4,12	3,86	3,62	3,40	3,21	3,03	2,86	2,71	2,57	2,44	2,32	2,20	2,07	1,93	1,80	
1,25	Pressure	Single	2,84	2,57	2,34	2,13	1,95	1,79	1,64	1,51	1,40	1,29	1,20	1,11				
		Double	4,41	4,13	3,88	3,65	3,43	3,24	3,06	2,90	2,75	2,61	2,48	2,36	2,25	2,15	2,05	
		Multiple	4,41	4,13	3,88	3,67	3,49	3,32	3,10	2,86	2,64	2,44	2,26	2,10	1,95	1,82	1,70	
	Suction	Single	3,78	3,43	3,12	2,84	2,60	2,38	2,19	2,02	1,86	1,72	1,60	1,48				
		Double	4,41	4,13	3,88	3,65	3,43	3,24	3,06	2,90	2,75	2,61	2,48	2,36	2,25	2,15	2,05	
		Multiple	5,51	5,16	4,85	4,56	4,29	4,05	3,83	3,63	3,44	3,26	3,02	2,80	2,61	2,43	2,27	
1,50	Pressure	Single	3,42	3,10	2,82	2,57	2,35	2,15	1,98	1,82	1,68	1,56	1,44	1,34	1,25	1,16		
		Double	5,50	5,15	4,84	4,55	4,28	4,04	3,82	3,62	3,43	3,26	3,09	2,95	2,81	2,68	2,56	
		Multiple	5,50	5,18	4,90	4,64	4,40	4,07	3,74	3,45	3,18	2,94	2,73	2,53	2,36	2,20	2,05	
	Suction	Single	4,56	4,13	3,76	3,43	3,13	2,87	2,64	2,43	2,24	2,08	1,92	1,79	1,66	1,55		
		Double	5,50	5,15	4,84	4,55	4,28	4,04	3,82	3,62	3,43	3,26	3,10	2,95	2,81	2,68	2,56	
		Multiple	6,88	6,44	6,04	5,68	5,35	5,05	4,78	4,52	4,24	3,93	3,64	3,38	3,14	2,93	2,73	

pressure load - deflection limit L/200
suction load - deflection limit L/150
the load shown is the ultimate load divided by 1,5

APPLIED STANDARDS / NOTES

Tolerances/Coatings	EN 10143	Steel Quality	EN 10346	Handling	European Recommendations
Tests/Calculations	EN 1990, EN 1991 1-6, EN 1993 1-3, EN 1993 1-5 (Calculations are to Eurocode, however additional checks such as fixings are required)				
	Deck self weight has not been allowed for, so has to be included in applied loads				

JI 158-250-750 Perfo Web (R5T12,5-DO)

JI

Application:	Structural metal roof deck	Finishing:	Interior liner and Galvanised
Yield Stress (MPa):	320	Intermediate Support width:	≥160 mm
Ym:	1	End Support width:	≥40 mm

■ = perforated zone

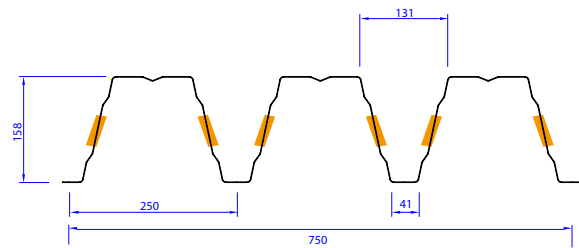

R5T12,5



Mechanical Properties

tN [mm]	Weight (kg/m ²)	Broad flange in compression						Narrow flange in compression					
		Mc,Rk,F [kNm/m]	Mc,Rk,B [kNm/m]	I _{eff} [cm ⁴ /m]	Vw,Rk [kN/m]	Rw,Rk,B [kN/m]	Rw,Rk,A [kN/m]	Mc,Rk,F [kNm/m]	Mc,Rk,B [kNm/m]	I _{eff} [cm ⁴ /m]	Vw,Rk [kN/m]	Rw,Rk,A [kN/m]	
0,75	11,78	14,68	12,03	422,09	24,86	31,51	9,33	12,03	14,68	429,22	24,86	24,86	
0,88	13,82	18,47	15,66	513,36	39,88	43,49	13,01	15,66	18,47	520,30	39,88	39,88	
1,00	15,71	22,03	19,21	595,93	57,94	55,93	16,88	19,21	22,03	594,46	57,94	57,94	
1,25	19,63	29,50	25,77	750,67	111,02	85,84	26,34	25,77	29,50	748,83	111,02	111,02	
1,50	23,56	36,77	31,08	905,23	188,61	120,87	37,60	31,08	36,77	903,00	188,61	188,61	

Load type (kN/m²)

Thickness (mm)			Span (m)														
			5,40	5,60	5,80	6,00	6,20	6,40	6,60	6,80	7,00	7,20	7,40	7,60	7,80	8,00	8,20
0,75	Pressure	Single	2,16	1,94	1,74	1,58	1,43	1,30	1,18								
		Double	2,27	2,14	2,02	1,92	1,81	1,72	1,64	1,56	1,48	1,42	1,35	1,29	1,24	1,18	1,14
		Multiple	2,30	2,22	2,14	2,07	2,01	1,91	1,80	1,69	1,60	1,51	1,43	1,36	1,29	1,22	1,16
	Suction	Single	2,20	2,05	1,91	1,78	1,67	1,57	1,47								
		Double	2,66	2,49	2,33	2,17	2,04	1,91	1,80	1,69	1,60	1,51	1,43	1,36	1,29	1,22	1,16
		Multiple	3,17	2,98	2,81	2,65	2,51	2,37	2,24	2,11	2,00	1,89	1,79	1,69	1,61	1,53	1,46
0,88	Pressure	Single	2,63	2,36	2,12	1,92	1,74	1,58	1,44	1,32	1,21	1,11					
		Double	3,03	2,86	2,70	2,55	2,42	2,29	2,18	2,07	1,97	1,88	1,80	1,71	1,62	1,54	1,47
		Multiple	3,21	3,10	2,93	2,74	2,56	2,41	2,26	2,13	2,01	1,90	1,80	1,71	1,62	1,53	1,42
	Suction	Single	2,86	2,66	2,48	2,32	2,17	2,04	1,92	1,78	1,63	1,50					
		Double	3,38	3,14	2,93	2,74	2,56	2,41	2,26	2,13	2,01	1,90	1,80	1,71	1,62	1,54	1,47
		Multiple	4,22	3,93	3,66	3,42	3,20	3,01	2,83	2,66	2,51	2,38	2,25	2,13	2,02	1,92	1,83
1,00	Pressure	Single	3,05	2,74	2,46	2,22	2,02	1,83	1,67	1,53	1,40	1,29	1,19				
		Double	3,79	3,57	3,37	3,19	3,02	2,86	2,70	2,54	2,40	2,27	2,15	2,03	1,93	1,84	1,75
		Multiple	4,03	3,75	3,49	3,26	3,06	2,87	2,70	2,54	2,40	2,27	2,15	2,03	1,92	1,78	1,65
	Suction	Single	3,51	3,27	3,05	2,85	2,67	2,44	2,22	2,03	1,86	1,71	1,58				
		Double	4,03	3,75	3,49	3,26	3,06	2,87	2,70	2,54	2,40	2,27	2,15	2,03	1,93	1,84	1,75
		Multiple	5,04	4,68	4,37	4,08	3,82	3,59	3,37	3,18	3,00	2,83	2,68	2,54	2,41	2,29	2,18
1,25	Pressure	Single	3,84	3,45	3,10	2,80	2,54	2,31	2,11	1,93	1,76	1,62	1,49	1,38	1,28	1,18	1,10
		Double	5,36	5,02	4,68	4,37	4,09	3,84	3,61	3,40	3,21	3,03	2,87	2,72	2,59	2,46	2,34
		Multiple	5,39	5,02	4,68	4,37	4,09	3,84	3,61	3,40	3,21	3,03	2,83	2,61	2,41	2,24	2,08
	Suction	Single	4,71	4,38	4,09	3,73	3,38	3,07	2,80	2,56	2,35	2,16	1,99	1,83	1,70	1,57	1,46
		Double	5,39	5,02	4,68	4,37	4,09	3,84	3,61	3,40	3,21	3,03	2,87	2,72	2,59	2,46	2,34
		Multiple	6,74	6,27	5,85	5,46	5,12	4,80	4,51	4,25	4,01	3,79	3,59	3,40	3,21	2,97	2,76
1,50	Pressure	Single	4,64	4,16	3,74	3,38	3,06	2,78	2,54	2,32	2,13	1,96	1,80	1,66	1,54	1,43	1,32
		Double	6,73	6,25	5,83	5,45	5,10	4,79	4,50	4,24	4,00	3,78	3,58	3,40	3,22	3,06	2,92
		Multiple	6,73	6,25	5,83	5,45	5,10	4,79	4,50	4,24	4,00	3,78	3,41	3,15	2,91	2,70	2,50
	Suction	Single	5,68	5,29	4,93	4,49	4,07	3,70	3,38	3,09	2,83	2,60	2,40	2,21	2,05	1,90	1,76
		Double	6,73	6,25	5,83	5,45	5,10	4,79	4,50	4,24	4,00	3,78	3,58	3,40	3,22	3,06	2,92
		Multiple	8,41	7,82	7,29	6,81	6,38	5,98	5,63	5,30	5,00	4,73	4,48	4,18	3,87	3,59	3,33

pressure load - deflection limit L/200
suction load - deflection limit L/150
the load shown is the ultimate load divided by 1,5

APPLIED STANDARDS / NOTES

Tolerances/Coatings	EN 10143	Steel Quality	EN 10346	Handling	European Recommendations
Tests/Calculations	EN 1990, EN 1991 1-6, EN 1993 1-3, EN 1993 1-5 (Calculations are to Eurocode, however additional checks such as fixings are required)				
	Deck self weight has not been allowed for, so has to be included in applied loads				

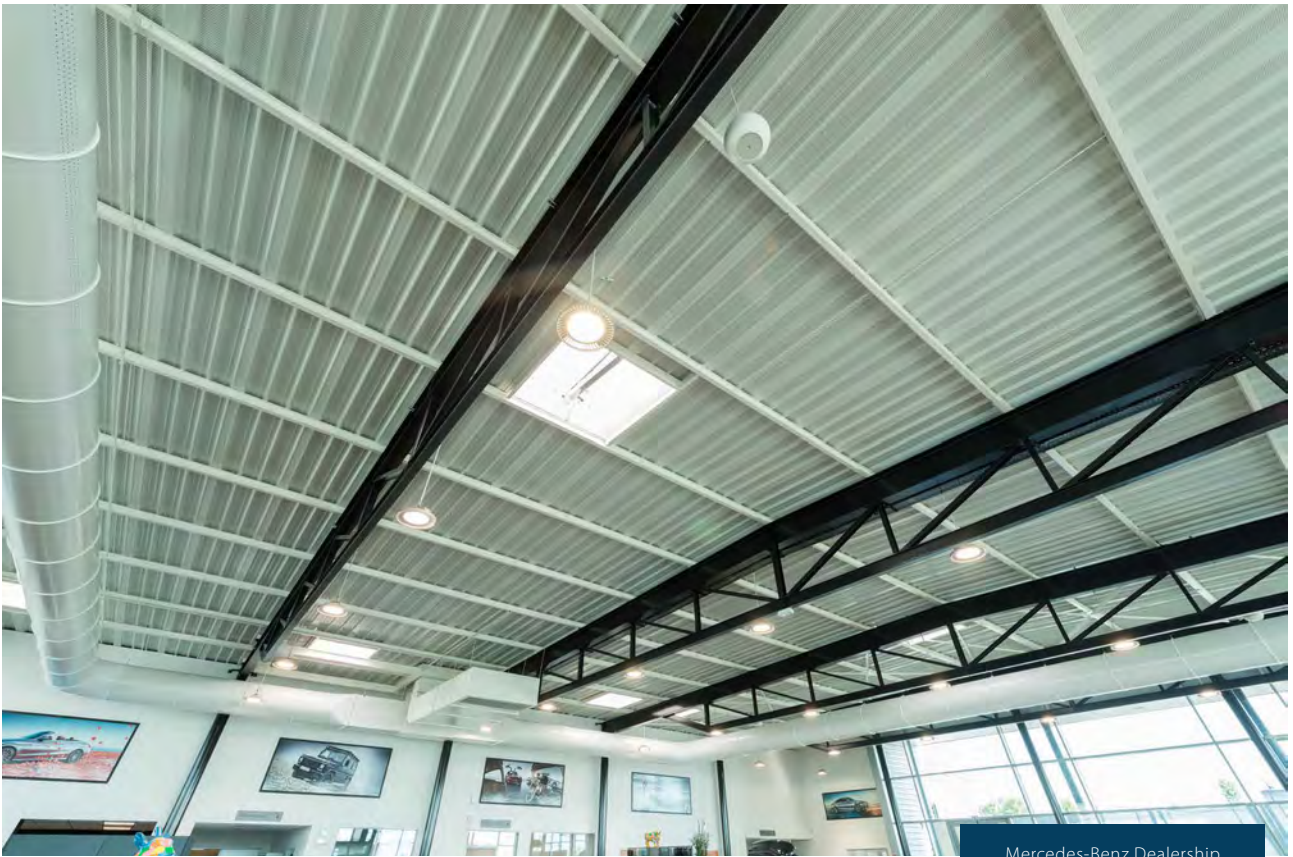

Mercedes-Benz Dealership

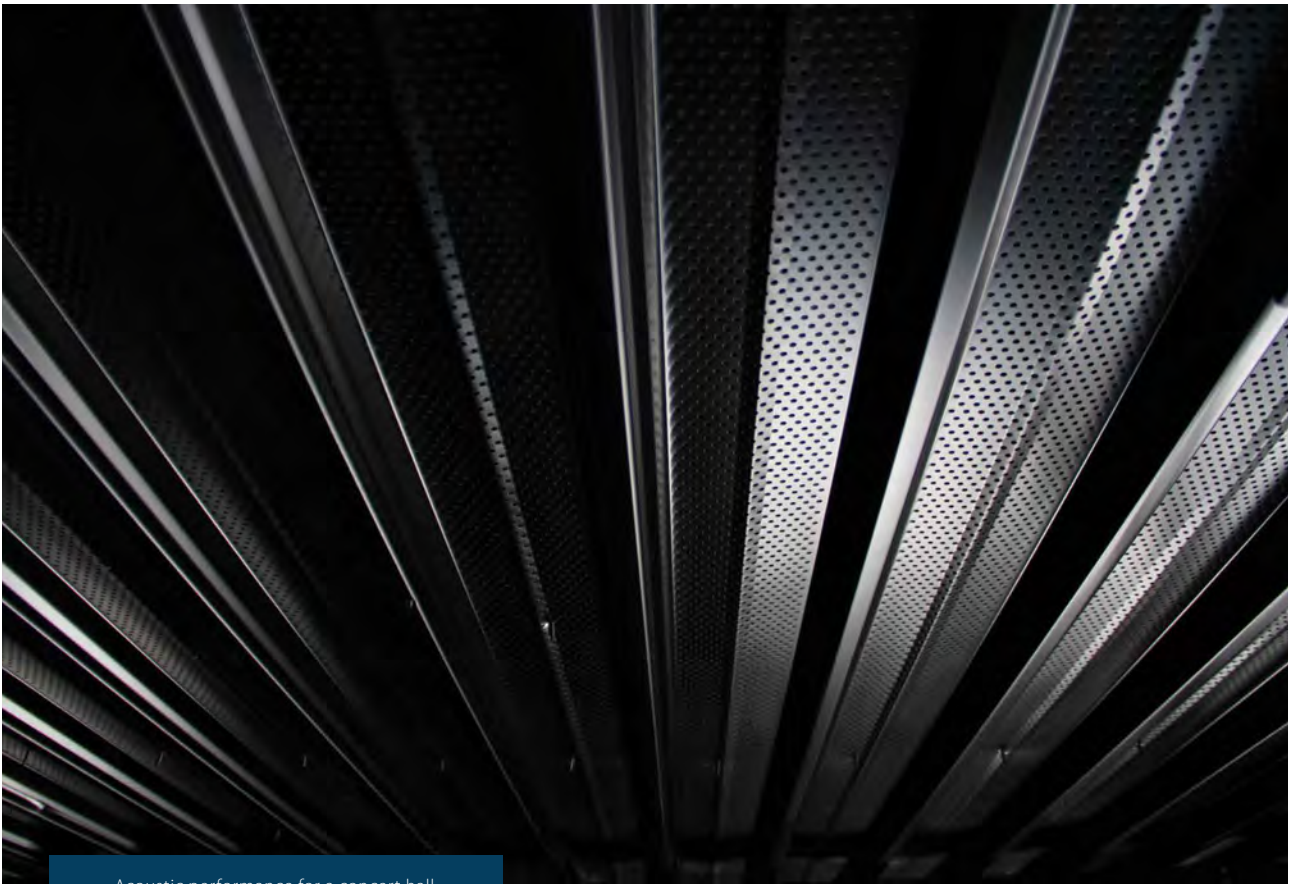

Acoustic performance for a concert hall.

Designer's guide to structural decking

Production site:

Joris Ide Ansbach, Germany

JID 50-250-1000

JID

Application:	Structural metal roof deck	Finishing:	Interior liner
Yield Stress (MPa):	320	Intermediate Support width:	≥60 mm
Ym:	1	End Support width:	≥40 mm

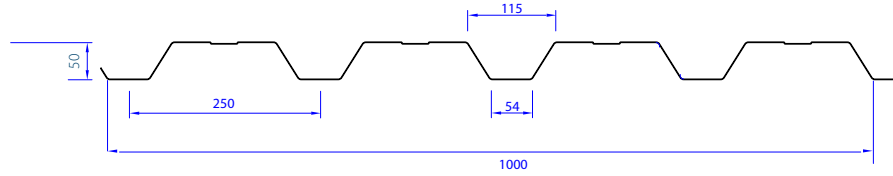

Mechanical Properties

tN [mm]	Weight (kg/m ²)	Broad flange in compression						Narrow flange in compression				
		Mc,Rk,F [kNm/m]	Mc,Rk,B [kNm/m]	I _{eff} [cm ⁴ /m]	Vw,Rk [kN/m]	Rw,Rk,B [kN/m]	Rw,Rk,A [kN/m]	Mc,Rk,F [kNm/m]	Mc,Rk,B [kNm/m]	I _{eff} [cm ⁴ /m]	Vw,Rk [kN/m]	Rw,Rk,A [kN/m]
0,75	7,36	2,42	2,59	22,57	45,86	19,15	8,31	2,59	2,42	29,58	45,86	45,86
0,88	8,64	3,10	3,27	28,10	64,19	25,88	11,26	3,27	3,10	36,79	64,19	64,19
1,00	9,81	3,79	3,94	33,47	80,79	32,84	14,34	3,94	3,79	43,74	80,79	80,79
1,25	12,27	5,40	5,43	45,33	101,79	49,58	21,76	5,43	5,40	57,89	101,79	101,79

Load type (kN/m²)

Thickness (mm)			Span (m)														
			1,20	1,40	1,60	1,80	2,00	2,20	2,40	2,60	2,80	3,00	3,20	3,40	3,60	3,80	4,00
0,75	Pressure	Single	8,97	6,59	4,44	3,12	2,27	1,71	1,32								
		Double	8,08	6,40	5,04	3,99	3,23	2,67	2,24	1,91	1,65	1,43	1,26	1,12			
		Multiple	8,97	6,59	5,04	3,99	3,23	2,77	2,41	1,96	1,57	1,27					
	Suction	Single	9,61	7,06	5,40	4,27	3,46	2,86	2,30								
		Double	8,97	6,59	5,04	3,99	3,23	2,67	2,24	1,91	1,65	1,43	1,26	1,12			
		Multiple	11,21	8,24	6,31	4,98	4,04	3,34	2,80	2,39	2,06	1,79					
0,88	Pressure	Single	11,49	8,26	5,53	3,89	2,83	2,13	1,64	1,29							
		Double	10,59	8,36	6,47	5,11	4,14	3,42	2,87	2,45	2,11	1,84	1,62	1,39	1,17		
		Multiple	11,49	8,44	6,47	5,11	4,20	3,60	3,10	2,44	1,95	1,59	1,31				
	Suction	Single	12,12	8,91	6,82	5,39	4,36	3,61	2,86	2,25							
		Double	11,49	8,44	6,47	5,11	4,14	3,42	2,87	2,45	2,11	1,84	1,62	1,43	1,28		
		Multiple	14,37	10,56	8,08	6,39	5,17	4,27	3,59	3,06	2,64	2,30	2,02				
1,00	Pressure	Single	14,05	9,84	6,59	4,63	3,37	2,53	1,95	1,54	1,23						
		Double	13,12	10,32	7,90	6,24	5,06	4,18	3,51	2,99	2,58	2,25	1,98	1,65	1,39	1,18	
		Multiple	14,05	10,32	7,90	6,24	5,18	4,43	3,69	2,90	2,33	1,89	1,56	1,30			
	Suction	Single	14,59	10,72	8,21	6,49	5,25	4,34	3,40	2,68	2,14						
		Double	14,05	10,32	7,90	6,24	5,06	4,18	3,51	2,99	2,58	2,25	1,98	1,75	1,56	1,40	
		Multiple	17,56	12,90	9,88	7,80	6,32	5,22	4,39	3,74	3,23	2,81	2,47	2,19			
1,25	Pressure	Single	20,01	13,32	8,93	6,27	4,57	3,43	2,64	2,08	1,67	1,35	1,12				
		Double	18,96	14,70	11,26	8,90	7,21	5,95	5,00	4,26	3,68	3,20	2,69	2,24	1,89	1,60	1,38
		Multiple	20,01	14,70	11,26	8,90	7,40	6,32	5,00	3,93	3,15	2,56	2,11	1,76	1,48	1,26	
	Suction	Single	20,11	14,77	11,31	8,94	7,24	5,85	4,50	3,54	2,84	2,31	1,90				
		Double	20,01	14,70	11,26	8,90	7,21	5,95	5,00	4,26	3,68	3,20	2,81	2,49	2,22	2,00	1,80
		Multiple	25,02	18,38	14,07	11,12	9,01	7,44	6,25	5,33	4,60	4,00	3,52	3,00	2,52	2,15	

pressure load - deflection limit L/200
suction load - deflection limit L/150
the load shown is the ultimate load divided by 1,5

APPLIED STANDARDS / NOTES

Tolerances/Coatings	EN 10143	Steel Quality	EN 10346	Handling	European Recommendations
Tests/Calculations	EN 1990, EN 1991 1-6, EN 1993 1-3, EN 1993 1-5 (Calculations are to Eurocode, however additional checks such as fixings are required)				
Deck self weight has not been allowed for, so has to be included in applied loads					

JID 50-250-1000 Perfo Flange (R5T8-P)

JID

Application:	Structural metal roof deck	Finishing:	Interior liner
Yield Stress (MPa):	320	Intermediate Support width:	≥60 mm
Ym:	1	End Support width:	≥40 mm

■ = perforated zone

R5T8

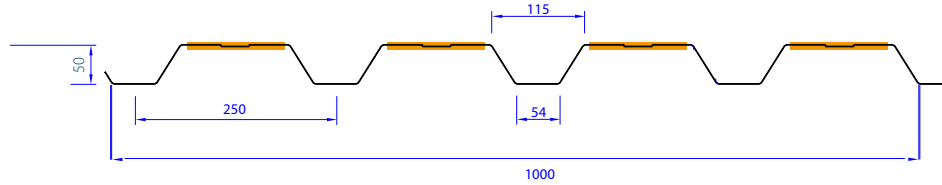

Mechanical Properties

tN [mm]	Weight (kg/m ²)	Broad flange in compression						Narrow flange in compression				
		Mc,Rk,F [kNm/m]	Mc,Rk,B [kNm/m]	Ieff [cm ⁴ /m]	Vw,Rk [kN/m]	Rw,Rk,B [kN/m]	Rw,Rk,A [kN/m]	Mc,Rk,F [kNm/m]	Mc,Rk,B [kNm/m]	Ieff [cm ⁴ /m]	Vw,Rk [kN/m]	Rw,Rk,A [kN/m]
0,75	7,36	1,78	2,41	17,43	45,86	19,15	8,31	2,41	1,78	23,66	45,86	45,86
0,88	8,64	2,20	3,04	21,34	64,19	25,88	11,26	3,04	2,20	29,31	64,19	64,19
1,00	9,81	2,61	3,66	25,12	80,79	32,84	14,34	3,66	2,61	34,74	80,79	80,79
1,25	12,27	3,53	5,06	33,42	101,79	49,58	21,76	5,06	3,53	45,80	101,79	101,79

Load type (kN/m²)

Thickness (mm)			Span (m)														
			1,20	1,40	1,60	1,80	2,00	2,20	2,40	2,60	2,80	3,00	3,20	3,40	3,60	3,80	4,00
0,75	Pressure	Single	6,57	4,83	3,43	2,41	1,76	1,32									
		Double	6,57	4,83	3,70	3,06	2,58	2,20	1,91	1,66	1,47	1,25					
		Multiple	6,86	5,43	4,42	3,67	3,10	2,50	1,92	1,51	1,21						
	Suction	Single	8,91	6,55	5,01	3,96	3,18	2,39									
		Double	6,57	4,83	3,70	2,92	2,37	1,96	1,64	1,40	1,21	1,05					
		Multiple	8,22	6,04	4,62	3,65	2,96	2,45	2,05	1,75	1,51						
0,88	Pressure	Single	8,13	5,97	4,20	2,95	2,15	1,62	1,25								
		Double	8,13	5,97	4,82	3,98	3,35	2,86	2,46	2,15	1,89	1,54	1,27				
		Multiple	9,00	7,11	5,77	4,78	4,03	3,06	2,35	1,85	1,48	1,21					
	Suction	Single	11,26	8,27	6,33	5,00	3,94	2,96	2,28								
		Double	8,13	5,97	4,57	3,61	2,93	2,42	2,03	1,73	1,49	1,30	1,14				
		Multiple	10,16	7,47	5,72	4,52	3,66	3,02	2,54	2,16	1,87	1,63					
1,00	Pressure	Single	9,65	7,09	4,95	3,47	2,53	1,90	1,47	1,15							
		Double	9,65	7,37	5,94	4,90	4,12	3,51	3,02	2,63	2,22	1,81	1,49	1,24			
		Multiple	11,15	8,79	7,12	5,89	4,79	3,60	2,77	2,18	1,75	1,42	1,17				
	Suction	Single	13,57	9,97	7,63	6,03	4,67	3,51	2,70	2,13							
		Double	9,65	7,09	5,43	4,29	3,48	2,87	2,41	2,06	1,77	1,54	1,36	1,20			
		Multiple	12,07	8,87	6,79	5,36	4,34	3,59	3,02	2,57	2,22	1,93	1,70				
1,25	Pressure	Single	13,09	9,62	6,58	4,62	3,37	2,53	1,95	1,53	1,23						
		Double	13,55	10,60	8,52	7,01	5,87	4,99	4,29	3,69	2,96	2,40	1,98	1,65	1,39	1,18	
		Multiple	16,14	12,67	10,23	8,44	6,37	4,79	3,69	2,90	2,32	1,89	1,56	1,30			
	Suction	Single	18,73	13,76	10,53	8,32	6,16	4,62	3,56	2,80	2,24						
		Double	13,09	9,62	7,36	5,82	4,71	3,89	3,27	2,79	2,40	2,09	1,84	1,63	1,45	1,31	
		Multiple	16,36	12,02	9,20	7,27	5,89	4,87	4,09	3,48	3,00	2,62	2,30	2,04			

pressure load - deflection limit L/200
suction load - deflection limit L/150
the load shown is the ultimate load divided by 1,5

APPLIED STANDARDS / NOTES

Tolerances/Coatings	EN 10143	Steel Quality	EN 10346	Handling	European Recommendations
Tests/Calculations	EN 1990, EN 1991 1-6, EN 1993 1-3, EN 1993 1-5 (Calculations are to Eurocode, however additional checks such as fixings are required)				
Deck self weight has not been allowed for, so has to be included in applied loads					

JID 50-250-1000 Perfo Web (R5T8-O)

JID

Application:	Structural metal roof deck	Finishing:	Interior liner
Yield Stress (MPa):	320	Intermediate Support width:	≥60 mm
Ym:	1	End Support width:	≥40 mm

■ = perforated zone

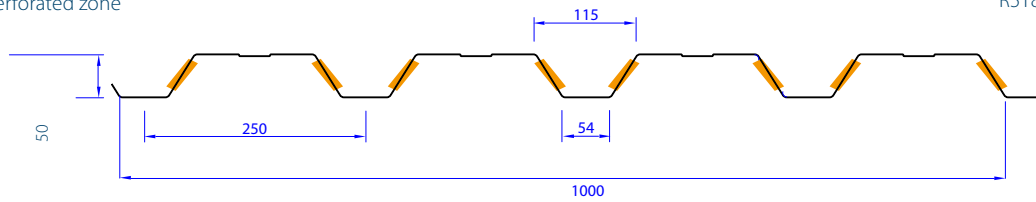

Mechanical Properties

tN [mm]	Weight (kg/m ²)	Broad flange in compression						Narrow flange in compression				
		Mc,Rk,F [kNm/m]	Mc,Rk,B [kNm/m]	I _{eff} [cm ⁴ /m]	Vw,Rk [kN/m]	Rw,Rk,B [kN/m]	Rw,Rk,A [kN/m]	Mc,Rk,F [kNm/m]	Mc,Rk,B [kNm/m]	I _{eff} [cm ⁴ /m]	Vw,Rk [kN/m]	Rw,Rk,A [kN/m]
0,75	7,36	2,06	1,94	20,54	26,23	10,72	4,62	1,94	2,06	26,36	26,23	26,23
0,88	8,64	2,69	2,65	25,75	37,23	14,53	6,28	2,65	2,69	33,17	37,23	37,23
1,00	9,81	3,34	3,29	30,83	48,62	18,48	8,01	3,29	3,34	39,79	48,62	48,62
1,25	12,27	4,88	4,64	42,04	77,46	27,95	12,18	4,64	4,88	53,18	77,46	77,46

Load type (kN/m²)

Thickness (mm)			Span (m)														
			1,20	1,40	1,60	1,80	2,00	2,20	2,40	2,60	2,80	3,00	3,20	3,40	3,60	3,80	4,00
0,75	Pressure	Single	5,13	4,40	3,85	2,84	2,07	1,56	1,20								
		Double	5,08	4,07	3,34	2,80	2,38	2,05	1,79	1,58	1,40	1,22					
		Multiple	5,13	4,40	3,85	3,33	2,74	2,27	1,91	1,62	1,40	1,16					
	Suction	Single	7,18	5,28	4,04	3,19	2,58	2,14	1,80								
		Double	7,62	5,60	4,29	3,39	2,74	2,27	1,91	1,62	1,40	1,22					
		Multiple	9,53	7,00	5,36	4,23	3,43	2,83	2,38	2,03	1,75	1,52					
0,88	Pressure	Single	6,98	5,98	5,07	3,56	2,60	1,95	1,50	1,18							
		Double	6,91	5,54	4,55	3,82	3,25	2,80	2,44	2,12	1,83	1,59	1,40	1,24			
		Multiple	6,98	5,98	5,24	4,43	3,59	2,96	2,49	2,12	1,79	1,45	1,20				
	Suction	Single	9,83	7,22	5,53	4,37	3,54	2,93	2,46	2,03							
		Double	9,96	7,32	5,60	4,43	3,59	2,96	2,49	2,12	1,83	1,59	1,40	1,24			
		Multiple	12,46	9,15	7,01	5,54	4,48	3,71	3,11	2,65	2,29	1,99	1,75				
1,00	Pressure	Single	8,90	7,63	6,07	4,26	3,11	2,33	1,80	1,41	1,13						
		Double	8,71	6,97	5,73	4,79	4,08	3,51	3,06	2,63	2,27	1,98	1,74	1,52	1,28		
		Multiple	8,90	7,63	6,68	5,50	4,45	3,68	3,09	2,63	2,14	1,74	1,43	1,20			
	Suction	Single	12,19	8,96	6,86	5,42	4,39	3,63	3,05	2,43	1,95						
		Double	12,37	9,09	6,96	5,50	4,45	3,68	3,09	2,63	2,27	1,98	1,74	1,54	1,37		
		Multiple	15,46	11,36	8,70	6,87	5,56	4,60	3,86	3,29	2,84	2,47	2,17	1,93			
1,25	Pressure	Single	13,53	11,60	8,28	5,81	4,24	3,18	2,45	1,93	1,54	1,26					
		Double	12,82	10,24	8,38	7,00	5,94	5,11	4,45	3,85	3,32	2,89	2,49	2,08	1,75	1,49	1,28
		Multiple	13,53	11,60	9,95	8,03	6,50	5,38	4,52	3,65	2,92	2,38	1,96	1,63	1,37	1,17	
	Suction	Single	17,17	12,62	9,66	7,63	6,18	5,11	4,14	3,25	2,60	2,12					
		Double	18,07	13,27	10,16	8,03	6,50	5,38	4,52	3,85	3,32	2,89	2,54	2,25	2,01	1,80	1,63
		Multiple	22,59	16,59	12,70	10,04	8,13	6,72	5,65	4,81	4,15	3,61	3,18	2,75	2,32	1,97	

pressure load - deflection limit L/200
suction load - deflection limit L/150
the load shown is the ultimate load divided by 1,5

APPLIED STANDARDS / NOTES

Tolerances/Coatings	EN 10143	Steel Quality	EN 10346	Handling	European Recommendations
Tests/Calculations	EN 1990, EN 1991 1-6, EN 1993 1-3, EN 1993 1-5 (Calculations are to Eurocode, however additional checks such as fixings are required)				
Deck self weight has not been allowed for, so has to be included in applied loads					

JID 85-280-1120

JID

Application:	Structural metal roof deck	Finishing:	Interior liner
Yield Stress (MPa):	320	Intermediate Support width:	≥160 mm
Ym:	1	End Support width:	≥40 mm

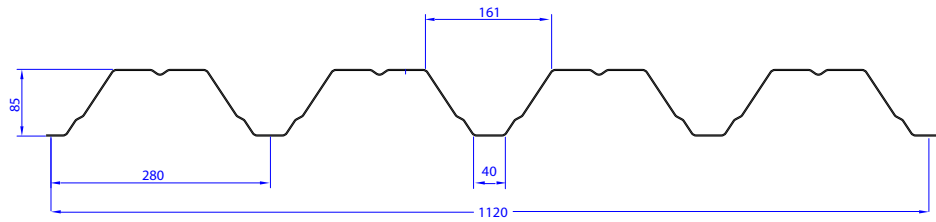

Mechanical Properties

tN [mm]	Weight (kg/m ²)	Broad flange in compression						Narrow flange in compression					
		Mc,Rk,F [kNm/m]	Mc,Rk,B [kNm/m]	I _{eff} [cm ⁴ /m]	Vw,Rk [kN/m]	Rw,Rk,B [kN/m]	Rw,Rk,A [kN/m]	Mc,Rk,F [kNm/m]	Mc,Rk,B [kNm/m]	I _{eff} [cm ⁴ /m]	Vw,Rk [kN/m]	Rw,Rk,A [kN/m]	
0,75	7,90	5,69	5,37	89,26	44,44	29,21	8,69	5,37	5,69	93,60	44,44	44,44	
0,88	9,27	7,34	6,60	109,34	69,80	40,28	12,12	6,60	7,34	114,04	69,80	69,80	
1,00	10,53	8,79	7,78	128,42	90,05	51,78	15,73	7,78	8,79	130,32	90,05	90,05	
1,25	13,17	12,03	10,26	164,21	140,21	79,46	24,54	10,26	12,03	164,21	140,21	140,21	
1,50	15,80	15,33	12,38	198,08	200,27	111,91	35,04	12,38	15,33	198,08	200,27	200,27	

Load type (kN/m²)

Thickness (mm)			Span (m)														
			3,20	3,40	3,60	3,80	4,00	4,20	4,40	4,60	4,80	5,00	5,20	5,40	5,60	5,80	6,00
0,75	Pressure	Single	2,20	1,83	1,54	1,31	1,12										
		Double	2,96	2,62	2,34	2,10	1,90	1,72	1,57	1,43	1,32	1,21	1,12				
		Multiple	2,96	2,62	2,38	2,17	1,99	1,83	1,60	1,40	1,23						
	Suction	Single	2,80	2,48	2,16	1,83	1,57										
		Double	2,96	2,62	2,34	2,10	1,90	1,72	1,57	1,43	1,32	1,21	1,12				
		Multiple	3,70	3,28	2,93	2,63	2,37	2,15	1,96	1,79	1,65						
0,88	Pressure	Single	2,69	2,24	1,89	1,61	1,38	1,19									
		Double	3,82	3,39	3,02	2,71	2,45	2,22	2,02	1,85	1,70	1,57	1,45	1,34	1,21		
		Multiple	3,82	3,39	3,05	2,78	2,54	2,25	1,96	1,71	1,51	1,33	1,19				
	Suction	Single	3,44	3,05	2,63	2,23	1,92	1,66									
		Double	3,82	3,39	3,02	2,71	2,45	2,22	2,02	1,85	1,70	1,57	1,45	1,34	1,25		
		Multiple	4,78	4,23	3,78	3,39	3,06	2,77	2,53	2,31	2,10	1,86	1,65				
1,00	Pressure	Single	3,16	2,63	2,22	1,89	1,62	1,40	1,22								
		Double	4,58	4,05	3,62	3,25	2,93	2,66	2,42	2,21	2,03	1,87	1,73	1,58	1,42	1,28	1,15
		Multiple	4,58	4,09	3,70	3,37	3,06	2,64	2,30	2,01	1,77	1,57	1,39	1,24	1,12		
	Suction	Single	4,05	3,56	3,00	2,55	2,19	1,89	1,64								
		Double	4,58	4,05	3,62	3,25	2,93	2,66	2,42	2,21	2,03	1,87	1,73	1,61	1,49	1,39	1,30
		Multiple	5,72	5,07	4,52	4,06	3,66	3,32	3,03	2,72	2,40	2,12	1,88	1,68	1,51		
1,25	Pressure	Single	4,04	3,37	2,84	2,41	2,07	1,79	1,55	1,36	1,20						
		Double	6,27	5,55	4,95	4,44	4,01	3,64	3,32	3,03	2,79	2,55	2,27	2,03	1,82	1,63	1,48
		Multiple	6,32	5,68	5,13	4,56	3,91	3,38	2,94	2,57	2,26	2,00	1,78	1,59	1,43	1,28	1,16
	Suction	Single	5,34	4,49	3,78	3,22	2,76	2,38	2,07	1,81	1,60						
		Double	6,27	5,55	4,95	4,44	4,01	3,64	3,32	3,03	2,79	2,57	2,37	2,20	2,05	1,91	1,78
		Multiple	7,83	6,94	6,19	5,56	5,01	4,51	3,92	3,43	3,02	2,67	2,38	2,12	1,90	1,71	1,55
1,50	Pressure	Single	4,87	4,06	3,42	2,91	2,50	2,16	1,88	1,64	1,44	1,28	1,14				
		Double	7,98	7,07	6,31	5,66	5,11	4,64	4,22	3,86	3,48	3,08	2,74	2,44	2,19	1,97	1,78
		Multiple	8,00	7,14	6,37	5,51	4,72	4,08	3,55	3,10	2,73	2,42	2,15	1,92	1,72	1,55	1,40
	Suction	Single	6,45	5,42	4,56	3,88	3,33	2,87	2,50	2,19	1,93	1,70	1,51				
		Double	7,98	7,07	6,31	5,66	5,11	4,64	4,22	3,86	3,55	3,27	3,02	2,80	2,61	2,43	2,27
		Multiple	9,98	8,84	7,89	7,08	6,29	5,44	4,73	4,14	3,64	3,22	2,86	2,56	2,29	2,06	1,86

pressure load - deflection limit L/200
suction load - deflection limit L/150
the load shown is the ultimate load divided by 1,5

APPLIED STANDARDS / NOTES

Tolerances/Coatings	EN 10143	Steel Quality	EN 10346	Handling	European Recommendations
Tests/Calculations	EN 1990, EN 1991 1-6, EN 1993 1-3, EN 1993 1-5 (Calculations are to Eurocode, however additional checks such as fixings are required)				
	Deck self weight has not been allowed for, so has to be included in applied loads				

JID 85-280-1120 Perfo Web (R5T8-DO)

JID

Application:	Structural metal roof deck	Finishing:	Interior liner
Yield Stress (MPa):	320	Intermediate Support width:	≥160 mm
Ym:	1	End Support width:	≥40 mm

■ = perforated zone

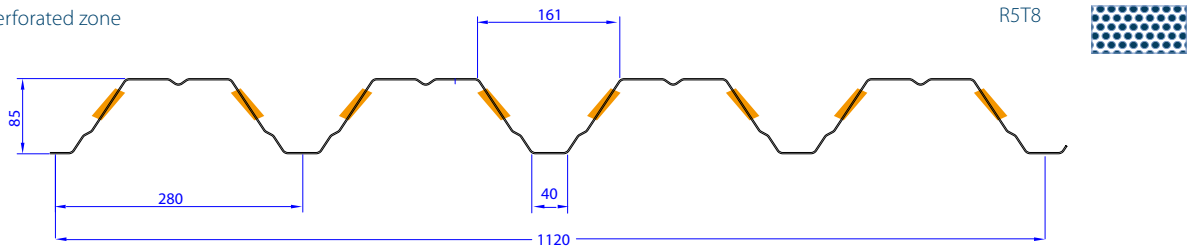

Mechanical Properties

tN [mm]	Weight (kg/m ²)	Broad flange in compression						Narrow flange in compression					
		Mc,Rk,F [kNm/m]	Mc,Rk,B [kNm/m]	I _{eff} [cm ⁴ /m]	Vw,Rk [kN/m]	Rw,Rk.B [kN/m]	Rw,Rk.A [kN/m]	Mc,Rk,F [kNm/m]	Mc,Rk,B [kNm/m]	I _{eff} [cm ⁴ /m]	Vw,Rk [kN/m]	Rw,Rk.A [kN/m]	
0,75	7,90	4,68	5,13	84,33	20,63	19,87	5,84	5,13	4,68	89,98	20,63	20,63	
0,88	9,27	6,29	6,33	104,49	33,19	27,51	8,17	6,33	6,29	109,74	33,19	33,19	
1,00	10,53	7,93	7,47	123,08	48,48	35,45	10,61	7,47	7,93	125,41	48,48	48,48	
1,25	13,17	11,19	9,90	157,62	88,01	54,59	16,60	9,90	11,19	158,04	88,01	88,01	
1,50	15,80	14,40	11,94	190,17	126,44	77,02	23,74	11,94	14,40	190,67	126,44	126,44	

Load type (kN/m²)

Thickness (mm)			Span (m)														
			3,00	3,20	3,40	3,60	3,80	4,00	4,20	4,40	4,60	4,80	5,00	5,20	5,40	5,60	5,80
0,75	Pressure	Single	2,52	2,08	1,73	1,46	1,24										
		Double	2,59	2,43	2,16	1,93	1,73	1,56	1,42	1,29	1,18						
		Multiple	2,62	2,43	2,16	1,96	1,80	1,66	1,53	1,42	1,32	1,16					
	Suction	Single	3,04	2,67	2,37	2,07	1,76										
		Double	2,78	2,44	2,16	1,93	1,73	1,56	1,42	1,29	1,18						
		Multiple	3,47	3,05	2,70	2,41	2,16	1,95	1,77	1,61	1,48	1,36					
0,88	Pressure	Single	3,12	2,57	2,14	1,81	1,54	1,32	1,14								
		Double	3,63	3,28	2,90	2,59	2,32	2,10	1,90	1,73	1,59	1,46	1,34	1,24	1,15		
		Multiple	3,63	3,28	2,90	2,59	2,34	2,15	1,98	1,83	1,64	1,44	1,28	1,13			
	Suction	Single	3,75	3,30	2,92	2,53	2,15	1,84	1,59								
		Double	3,73	3,28	2,90	2,59	2,32	2,10	1,90	1,73	1,59	1,46	1,34	1,24	1,15		
		Multiple	4,66	4,09	3,63	3,24	2,90	2,62	2,38	2,17	1,98	1,82	1,68	1,55			
1,00	Pressure	Single	3,68	3,03	2,53	2,13	1,81	1,55	1,34	1,17							
		Double	4,70	4,13	3,66	3,26	2,93	2,64	2,40	2,18	2,00	1,84	1,69	1,56	1,45	1,35	1,23
		Multiple	4,70	4,13	3,66	3,26	2,93	2,64	2,42	2,20	1,93	1,70	1,50	1,34	1,19		
	Suction	Single	4,43	3,89	3,43	2,89	2,46	2,11	1,82	1,58							
		Double	4,70	4,13	3,66	3,26	2,93	2,64	2,40	2,18	2,00	1,84	1,69	1,56	1,45	1,35	1,26
		Multiple	5,87	5,16	4,57	4,08	3,66	3,30	3,00	2,73	2,50	2,29	2,04	1,81	1,62		
1,25	Pressure	Single	4,71	3,88	3,23	2,72	2,32	1,99	1,72	1,49	1,31	1,15					
		Double	6,63	5,83	5,16	4,60	4,13	3,73	3,38	3,08	2,82	2,59	2,39	2,18	1,94	1,74	1,57
		Multiple	6,63	5,83	5,16	4,60	4,13	3,73	3,24	2,82	2,47	2,17	1,92	1,71	1,53	1,37	1,23
	Suction	Single	5,87	5,16	4,32	3,64	3,10	2,66	2,29	1,99	1,75	1,54					
		Double	6,63	5,83	5,16	4,60	4,13	3,73	3,38	3,08	2,82	2,59	2,39	2,21	2,05	1,90	1,77
		Multiple	8,29	7,28	6,45	5,75	5,16	4,66	4,23	3,77	3,30	2,91	2,57	2,29	2,04	1,83	1,65
1,50	Pressure	Single	5,68	4,68	3,90	3,29	2,79	2,40	2,07	1,80	1,58	1,39	1,23				
		Double	8,53	7,50	6,64	5,92	5,32	4,80	4,35	3,97	3,63	3,33	2,96	2,63	2,35	2,10	1,89
		Multiple	8,53	7,50	6,64	5,92	5,29	4,53	3,91	3,40	2,98	2,62	2,32	2,06	1,84	1,65	1,49
	Suction	Single	7,08	6,22	5,22	4,39	3,74	3,20	2,77	2,41	2,11	1,85	1,64				
		Double	8,53	7,50	6,64	5,92	5,32	4,80	4,35	3,97	3,63	3,33	3,07	2,84	2,63	2,45	2,28
		Multiple	10,66	9,37	8,30	7,41	6,65	6,00	5,23	4,55	3,98	3,51	3,10	2,76	2,46	2,21	1,99

pressure load - deflection limit L/200
suction load - deflection limit L/150
the load shown is the ultimate load divided by 1,5

APPLIED STANDARDS / NOTES

Tolerances/Coatings	EN 10143	Steel Quality	EN 10346	Handling	European Recommendations
Tests/Calculations	EN 1990, EN 1991 1-6, EN 1993 1-3, EN 1993 1-5 (Calculations are to Eurocode, however additional checks such as fixings are required)				
	Deck self weight has not been allowed for, so has to be included in applied loads				

JID 89-305-915

JID

Application:	Structural metal roof deck	Finishing:	Interior liner
Yield Stress (MPa):	320	Intermediate Support width:	≥160 mm
Ym:	1	End Support width:	≥40 mm

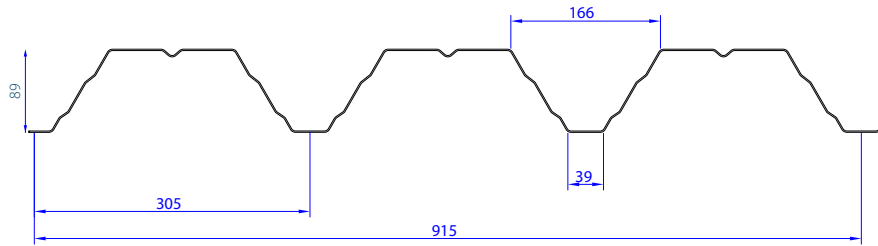

Mechanical Properties

tN [mm]	Weight (kg/m ²)	Broad flange in compression						Narrow flange in compression				
		Mc,Rk,F [kNm/m]	Mc,Rk,B [kNm/m]	I _{eff} [cm ⁴ /m]	Vw,Rk [kN/m]	Rw,Rk,B [kN/m]	Rw,Rk,A [kN/m]	Mc,Rk,F [kNm/m]	Mc,Rk,B [kNm/m]	I _{eff} [cm ⁴ /m]	Vw,Rk [kN/m]	Rw,Rk,A [kN/m]
0,75	8,04	5,91	5,54	96,23	41,77	27,13	8,07	5,54	5,91	106,14	41,77	41,77
0,88	9,43	7,41	6,80	118,06	66,89	37,44	11,27	6,80	7,41	128,59	66,89	66,89
1,00	10,72	8,87	7,99	138,85	86,13	48,14	14,62	7,99	8,87	146,94	86,13	86,13
1,25	13,40	11,81	10,46	183,77	133,00	73,89	22,82	10,46	11,81	185,14	133,00	133,00
1,50	16,08	14,24	12,62	223,33	189,60	104,05	32,58	12,62	14,24	223,33	189,60	189,60

Load type (kN/m²)

Thickness (mm)			Span (m)														
			3,20	3,40	3,60	3,80	4,00	4,20	4,40	4,60	4,80	5,00	5,20	5,40	5,60	5,80	6,00
0,75	Pressure	Single	2,37	1,97	1,66	1,41	1,21										
		Double	3,08	2,73	2,43	2,18	1,97	1,79	1,63	1,49	1,37	1,26	1,17				
		Multiple	3,08	2,73	2,43	2,18	1,97	1,82	1,68	1,51	1,33	1,17					
	Suction	Single	2,89	2,56	2,28	2,05	1,78										
		Double	3,08	2,73	2,43	2,18	1,97	1,79	1,63	1,49	1,37	1,26	1,17				
		Multiple	3,85	3,41	3,04	2,73	2,46	2,23	2,04	1,86	1,71	1,58					
0,88	Pressure	Single	2,91	2,42	2,04	1,73	1,49	1,28	1,12								
		Double	3,86	3,42	3,05	2,74	2,47	2,24	2,04	1,87	1,71	1,58	1,46	1,35	1,26	1,17	
		Multiple	3,86	3,42	3,05	2,76	2,53	2,32	2,11	1,85	1,63	1,44	1,28	1,14			
	Suction	Single	3,54	3,14	2,80	2,51	2,16	1,87	1,62								
		Double	3,86	3,42	3,05	2,74	2,47	2,24	2,04	1,87	1,71	1,58	1,46	1,35	1,26	1,17	
		Multiple	4,82	4,27	3,81	3,42	3,09	2,80	2,55	2,33	2,14	1,98	1,83	1,66			
1,00	Pressure	Single	3,42	2,85	2,40	2,04	1,75	1,51	1,31	1,15							
		Double	4,62	4,09	3,65	3,28	2,96	2,68	2,44	2,24	2,05	1,89	1,75	1,62	1,51	1,38	1,25
		Multiple	4,62	4,09	3,67	3,35	3,06	2,81	2,49	2,18	1,91	1,69	1,51	1,34	1,21		
	Suction	Single	4,16	3,69	3,29	2,88	2,47	2,13	1,85	1,62							
		Double	4,62	4,09	3,65	3,28	2,96	2,68	2,44	2,24	2,05	1,89	1,75	1,62	1,51	1,41	1,31
		Multiple	5,77	5,11	4,56	4,09	3,69	3,35	3,05	2,79	2,57	2,36	2,13	1,90	1,70		
1,25	Pressure	Single	4,52	3,77	3,18	2,70	2,32	2,00	1,74	1,52	1,34	1,19					
		Double	6,15	5,45	4,86	4,36	3,94	3,57	3,25	2,98	2,73	2,52	2,33	2,16	2,01	1,83	1,65
		Multiple	6,24	5,61	5,08	4,62	4,22	3,78	3,29	2,88	2,53	2,24	1,99	1,78	1,60	1,44	1,30
	Suction	Single	5,45	4,83	4,27	3,63	3,11	2,69	2,34	2,05	1,80	1,59					
		Double	6,15	5,45	4,86	4,36	3,94	3,57	3,25	2,98	2,73	2,52	2,33	2,16	2,01	1,87	1,75
		Multiple	7,69	6,81	6,08	5,45	4,92	4,46	4,07	3,72	3,40	3,01	2,68	2,39	2,14	1,93	1,74
1,50	Pressure	Single	5,50	4,58	3,86	3,28	2,81	2,43	2,11	1,85	1,63	1,44	1,28	1,14			
		Double	7,41	6,57	5,86	5,26	4,75	4,30	3,92	3,59	3,30	3,04	2,81	2,60	2,42	2,22	2,01
		Multiple	7,93	7,12	6,43	5,82	5,26	4,60	4,00	3,50	3,08	2,73	2,42	2,16	1,94	1,75	1,58
	Suction	Single	6,57	5,82	5,15	4,38	3,75	3,24	2,82	2,47	2,17	1,92	1,71	1,52			
		Double	7,41	6,57	5,86	5,26	4,75	4,30	3,92	3,59	3,30	3,04	2,81	2,60	2,42	2,26	2,11
		Multiple	9,27	8,21	7,32	6,57	5,93	5,38	4,90	4,49	4,11	3,63	3,23	2,88	2,59	2,33	2,10

pressure load - deflection limit L/200
suction load - deflection limit L/150
the load shown is the ultimate load divided by 1,5

APPLIED STANDARDS / NOTES

Tolerances/Coatings	EN 10143	Steel Quality	EN 10346	Handling	European Recommendations
Tests/Calculations	EN 1990, EN 1991 1-6, EN 1993 1-3, EN 1993 1-5 (Calculations are to Eurocode, however additional checks such as fixings are required)				
	Deck self weight has not been allowed for, so has to be included in applied loads				

JID 89-305-915 Perfo Web (R5T8-DO)

JID

Application:	Structural metal roof deck	Finishing:	Interior liner
Yield Stress (MPa):	320	Intermediate Support width:	≥160 mm
Ym:	1	End Support width:	≥40 mm

■ = perforated zone

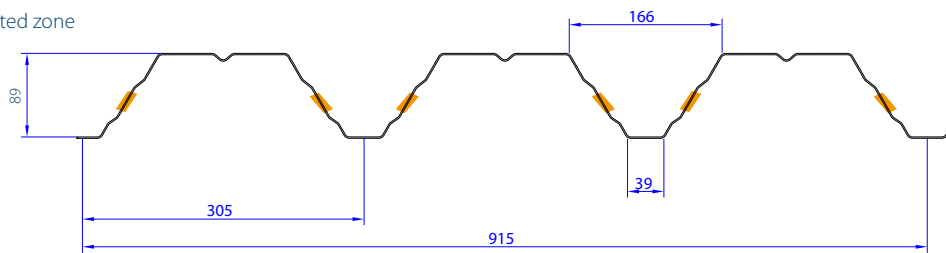

R5T8



Mechanical Properties

tN [mm]	Weight (kg/m ²)	Broad flange in compression						Narrow flange in compression				
		Mc,Rk,F [kNm/m]	Mc,Rk,B [kNm/m]	I _{eff} [cm ⁴ /m]	Vw,Rk [kN/m]	Rw,Rk,B [kN/m]	Rw,Rk,A [kN/m]	Mc,Rk,F [kNm/m]	Mc,Rk,B [kNm/m]	I _{eff} [cm ⁴ /m]	Vw,Rk [kN/m]	Rw,Rk,A [kN/m]
0,75	8,04	5,65	5,01	91,69	18,70	17,60	5,16	5,01	5,65	102,37	18,70	18,70
0,88	9,43	6,69	6,28	110,60	30,08	24,38	7,22	6,28	6,69	124,31	30,08	30,08
1,00	10,72	7,64	7,43	129,71	43,81	31,42	9,39	7,43	7,64	142,05	43,81	43,81
1,25	13,40	9,62	9,77	170,78	81,44	48,37	14,68	9,77	9,62	178,99	81,44	81,44
1,50	16,08	11,59	11,78	207,36	116,34	68,23	20,99	11,78	11,59	215,90	116,34	116,34

Load type (kN/m²)

Thickness (mm)			Span (m)														
			3,20	3,40	3,60	3,80	4,00	4,20	4,40	4,60	4,80	5,00	5,20	5,40	5,60	5,80	6,00
0,75	Pressure	Single	2,15	1,88	1,58	1,35	1,16										
		Double	2,15	2,02	1,91	1,81	1,72	1,61	1,50	1,39	1,30	1,21	1,12				
		Multiple	2,20	2,02	1,91	1,81	1,72	1,64	1,56	1,42	1,26	1,12					
	Suction	Single	2,61	2,31	2,06	1,85	1,67										
		Double	2,94	2,61	2,33	2,09	1,88	1,71	1,56	1,42	1,31	1,21	1,12				
		Multiple	3,63	3,25	2,91	2,61	2,36	2,14	1,95	1,78	1,64	1,51					
0,88	Pressure	Single	2,72	2,27	1,91	1,63	1,39	1,20									
		Double	3,01	2,83	2,68	2,47	2,23	2,02	1,84	1,69	1,55	1,43	1,32	1,22	1,14		
		Multiple	3,01	2,83	2,68	2,47	2,23	2,02	1,84	1,69	1,53	1,35	1,20				
	Suction	Single	3,27	2,90	2,58	2,32	2,09	1,80									
		Double	3,48	3,08	2,75	2,47	2,23	2,02	1,84	1,69	1,55	1,43	1,32	1,22	1,14		
		Multiple	4,35	3,86	3,44	3,09	2,79	2,53	2,30	2,11	1,93	1,78	1,65				
1,00	Pressure	Single	3,19	2,66	2,24	1,91	1,63	1,41	1,23								
		Double	3,91	3,52	3,14	2,82	2,55	2,31	2,10	1,93	1,77	1,63	1,51	1,40	1,30	1,21	1,13
		Multiple	3,91	3,52	3,14	2,82	2,55	2,31	2,13	1,98	1,79	1,58	1,41	1,26	1,13		
	Suction	Single	3,87	3,43	3,06	2,74	2,39	2,06	1,79								
		Double	3,98	3,52	3,14	2,82	2,55	2,31	2,10	1,93	1,77	1,63	1,51	1,40	1,30	1,21	1,13
		Multiple	4,97	4,40	3,93	3,53	3,18	2,89	2,63	2,41	2,21	2,04	1,88	1,75	1,62		
1,25	Pressure	Single	4,20	3,50	2,95	2,51	2,15	1,86	1,62	1,41	1,25	1,10					
		Double	5,01	4,44	3,96	3,55	3,21	2,91	2,65	2,42	2,23	2,05	1,90	1,76	1,64	1,52	1,42
		Multiple	5,06	4,58	4,16	3,81	3,49	3,22	2,97	2,68	2,36	2,08	1,85	1,65	1,48	1,34	1,21
	Suction	Single	5,09	4,51	4,02	3,51	3,01	2,60	2,26	1,98	1,74	1,54					
		Double	5,01	4,44	3,96	3,55	3,21	2,91	2,65	2,42	2,23	2,05	1,90	1,76	1,64	1,52	1,42
		Multiple	6,26	5,55	4,95	4,44	4,01	3,63	3,31	3,03	2,78	2,56	2,37	2,20	2,04	1,87	1,69
1,50	Pressure	Single	5,10	4,25	3,58	3,05	2,61	2,26	1,96	1,72	1,51	1,34	1,19				
		Double	6,03	5,35	4,77	4,28	3,86	3,50	3,19	2,92	2,68	2,48	2,31	2,16	2,00	1,87	1,75
		Multiple	6,52	5,88	5,34	4,87	4,46	4,10	3,71	3,25	2,86	2,53	2,25	2,01	1,80	1,62	1,46
	Suction	Single	6,14	5,44	4,85	4,23	3,63	3,13	2,73	2,38	2,10	1,86	1,65				
		Double	6,03	5,35	4,77	4,28	3,86	3,50	3,19	2,92	2,68	2,47	2,29	2,12	1,97	1,84	1,72
		Multiple	7,54	6,68	5,96	5,35	4,83	4,38	3,99	3,65	3,35	3,09	2,86	2,65	2,46	2,25	2,03

pressure load - deflection limit L/200
suction load - deflection limit L/150
the load shown is the ultimate load divided by 1,5

APPLIED STANDARDS / NOTES

Tolerances/Coatings	EN 10143	Steel Quality	EN 10346	Handling	European Recommendations
Tests/Calculations	EN 1990, EN 1991 1-6, EN 1993 1-3, EN 1993 1-5 (Calculations are to Eurocode, however additional checks such as fixings are required)				
	Deck self weight has not been allowed for, so has to be included in applied loads				

JID 100-275-825

JID

Application:	Structural metal roof deck	Finishing:	Interior liner
Yield Stress (MPa):	320	Intermediate Support width:	≥160 mm
Ym:	1	End Support width:	≥40 mm

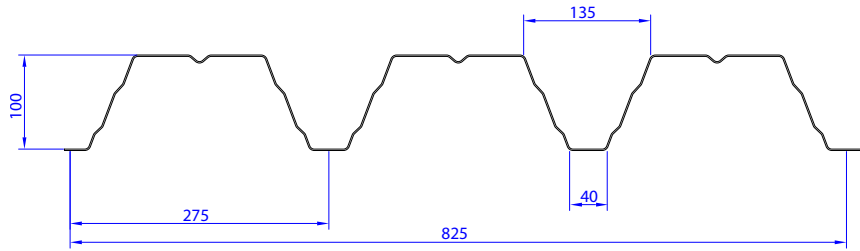

Mechanical Properties

tN [mm]	Weight (kg/m ²)	Broad flange in compression						Narrow flange in compression					
		Mc,Rk,F [kNm/m]	Mc,Rk,B [kNm/m]	I _{eff} [cm ⁴ /m]	Vw,Rk [kN/m]	Rw,Rk,B [kN/m]	Rw,Rk,A [kN/m]	Mc,Rk,F [kNm/m]	Mc,Rk,B [kNm/m]	I _{eff} [cm ⁴ /m]	Vw,Rk [kN/m]	Rw,Rk,A [kN/m]	
0,75	8,92	7,22	6,35	129,06	46,60	31,99	9,52	6,35	7,22	141,28	46,60	46,60	
0,88	10,47	9,05	8,17	158,28	74,12	44,05	13,26	8,17	9,05	171,70	74,12	74,12	
1,00	11,89	10,82	9,62	186,12	95,46	56,57	17,18	9,62	10,82	196,18	95,46	95,46	
1,25	14,87	14,53	12,64	246,23	147,41	86,66	26,76	12,64	14,53	247,15	147,41	147,41	
1,50	17,84	17,51	15,24	299,43	210,15	121,90	38,17	15,24	17,51	298,07	210,15	210,15	

Load type (kN/m²)

Thickness (mm)			Span (m)														
			4,00	4,20	4,40	4,60	4,80	5,00	5,20	5,40	5,60	5,80	6,00	6,20	6,40	6,60	6,80
0,75	Pressure	Single	1,63	1,40	1,22												
		Double	2,41	2,18	1,99	1,82	1,67	1,54	1,42	1,32	1,23	1,15					
		Multiple	2,41	2,18	1,99	1,82	1,67	1,56	1,40	1,25	1,12						
	Suction	Single	2,12	1,92	1,75												
		Double	2,41	2,18	1,99	1,82	1,67	1,54	1,42	1,32	1,23	1,15					
		Multiple	3,01	2,73	2,49	2,28	2,09	1,93	1,78	1,65	1,54						
0,88	Pressure	Single	1,99	1,72	1,50	1,31	1,15										
		Double	3,02	2,74	2,49	2,28	2,09	1,93	1,78	1,65	1,54	1,43	1,34	1,26	1,17		
		Multiple	3,02	2,77	2,56	2,37	2,18	1,93	1,72	1,53	1,37	1,24	1,12				
	Suction	Single	2,72	2,47	2,17	1,90	1,67										
		Double	3,02	2,74	2,49	2,28	2,09	1,93	1,78	1,65	1,54	1,43	1,34	1,26	1,18		
		Multiple	3,77	3,42	3,12	2,85	2,62	2,41	2,23	2,07	1,92	1,79	1,62				
1,00	Pressure	Single	2,35	2,03	1,76	1,54	1,36	1,20									
		Double	3,61	3,27	2,98	2,73	2,51	2,31	2,13	1,98	1,84	1,72	1,60	1,50	1,38	1,26	1,15
		Multiple	3,66	3,36	3,10	2,87	2,57	2,27	2,02	1,80	1,62	1,45	1,31	1,19			
	Suction	Single	3,21	2,85	2,48	2,17	1,91	1,69									
		Double	3,61	3,27	2,98	2,73	2,51	2,31	2,13	1,98	1,84	1,72	1,60	1,50	1,41	1,33	1,25
		Multiple	4,51	4,09	3,73	3,41	3,13	2,89	2,67	2,47	2,27	2,04	1,85	1,67			
1,25	Pressure	Single	3,10	2,68	2,33	2,04	1,80	1,59	1,41	1,26	1,13						
		Double	4,84	4,39	4,00	3,66	3,36	3,10	2,87	2,66	2,47	2,30	2,15	2,01	1,82	1,66	1,52
		Multiple	5,05	4,63	4,27	3,86	3,40	3,00	2,67	2,39	2,14	1,92	1,74	1,58	1,43	1,31	1,19
	Suction	Single	4,15	3,59	3,12	2,73	2,40	2,13	1,89	1,69	1,51						
		Double	4,84	4,39	4,00	3,66	3,36	3,10	2,87	2,66	2,47	2,30	2,15	2,02	1,89	1,78	1,68
		Multiple	6,06	5,49	5,00	4,58	4,20	3,88	3,57	3,19	2,86	2,58	2,33	2,11	1,92	1,75	1,60
1,50	Pressure	Single	3,77	3,26	2,83	2,48	2,18	1,93	1,72	1,53	1,37	1,24	1,12				
		Double	5,84	5,30	4,82	4,41	4,05	3,74	3,45	3,20	2,98	2,78	2,59	2,43	2,22	2,02	1,85
		Multiple	6,35	5,76	5,25	4,69	4,13	3,65	3,25	2,90	2,60	2,34	2,11	1,92	1,74	1,59	1,45
	Suction	Single	5,01	4,33	3,76	3,29	2,90	2,56	2,28	2,04	1,82	1,64	1,48				
		Double	5,84	5,30	4,82	4,41	4,05	3,74	3,45	3,20	2,98	2,78	2,59	2,43	2,28	2,14	2,02
		Multiple	7,30	6,62	6,03	5,52	5,07	4,67	4,31	3,85	3,45	3,11	2,81	2,54	2,31	2,11	1,93

pressure load - deflection limit L/200
suction load - deflection limit L/150
the load shown is the ultimate load divided by 1,5

APPLIED STANDARDS / NOTES

Tolerances/Coatings	EN 10143	Steel Quality	EN 10346	Handling	European Recommendations
Tests/Calculations	EN 1990, EN 1991 1-6, EN 1993 1-3, EN 1993 1-5 (Calculations are to Eurocode, however additional checks such as fixings are required)				
	Deck self weight has not been allowed for, so has to be included in applied loads				

JID 100-275-825 Perfo Web (R5T8-DO)

JID

Application:	Structural metal roof deck	Finishing:	Interior liner
Yield Stress (MPa):	320	Intermediate Support width:	≥160 mm
Ym:	1	End Support width:	≥40 mm

■ = perforated zone

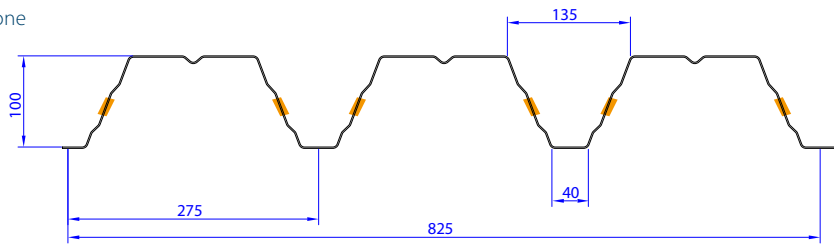

R5T8



Mechanical Properties

tN [mm]	Weight (kg/m ²)	Broad flange in compression						Narrow flange in compression					
		Mc,Rk,F [kNm/m]	Mc,Rk,B [kNm/m]	I _{eff} [cm ⁴ /m]	Vw,Rk [kN/m]	Rw,Rk,B [kN/m]	Rw,Rk,A [kN/m]	Mc,Rk,F [kNm/m]	Mc,Rk,B [kNm/m]	I _{eff} [cm ⁴ /m]	Vw,Rk [kN/m]	Rw,Rk,A [kN/m]	
0,75	8,92	7,22	6,35	129,06	46,60	31,99	9,52	6,35	7,22	141,28	46,60	46,60	
0,88	10,47	9,05	8,17	158,28	74,12	44,05	13,26	8,17	9,05	171,70	74,12	74,12	
1,00	11,89	10,82	9,62	186,12	95,46	56,57	17,18	9,62	10,82	196,18	95,46	95,46	
1,25	14,87	14,53	12,64	246,23	147,41	86,66	26,76	12,64	14,53	247,15	147,41	147,41	
1,50	17,84	17,51	15,24	299,43	210,15	121,90	38,17	15,24	17,51	298,07	210,15	210,15	

Load type (kN/m²)

Thickness (mm)			Span (m)														
			4,00	4,20	4,40	4,60	4,80	5,00	5,20	5,40	5,60	5,80	6,00	6,20	6,40	6,60	6,80
0,75	Pressure	Single	1,63	1,40	1,22												
		Double	2,41	2,18	1,99	1,82	1,67	1,54	1,42	1,32	1,23	1,15					
		Multiple	2,41	2,18	1,99	1,82	1,67	1,56	1,40	1,25	1,12						
	Suction	Single	2,12	1,92	1,75												
		Double	2,41	2,18	1,99	1,82	1,67	1,54	1,42	1,32	1,23	1,15					
		Multiple	3,01	2,73	2,49	2,28	2,09	1,93	1,78	1,65	1,54						
0,88	Pressure	Single	1,99	1,72	1,50	1,31	1,15										
		Double	3,02	2,74	2,49	2,28	2,09	1,93	1,78	1,65	1,54	1,43	1,34	1,26	1,17		
		Multiple	3,02	2,77	2,56	2,37	2,18	1,93	1,72	1,53	1,37	1,24	1,12				
	Suction	Single	2,72	2,47	2,17	1,90	1,67										
		Double	3,02	2,74	2,49	2,28	2,09	1,93	1,78	1,65	1,54	1,43	1,34	1,26	1,18		
		Multiple	3,77	3,42	3,12	2,85	2,62	2,41	2,23	2,07	1,92	1,79	1,62				
1,00	Pressure	Single	2,35	2,03	1,76	1,54	1,36	1,20									
		Double	3,61	3,27	2,98	2,73	2,51	2,31	2,13	1,98	1,84	1,72	1,60	1,50	1,38	1,26	1,15
		Multiple	3,66	3,36	3,10	2,87	2,57	2,27	2,02	1,80	1,62	1,45	1,31	1,19			
	Suction	Single	3,21	2,85	2,48	2,17	1,91	1,69									
		Double	3,61	3,27	2,98	2,73	2,51	2,31	2,13	1,98	1,84	1,72	1,60	1,50	1,41	1,33	1,25
		Multiple	4,51	4,09	3,73	3,41	3,13	2,89	2,67	2,47	2,27	2,04	1,85	1,67			
1,25	Pressure	Single	3,10	2,68	2,33	2,04	1,80	1,59	1,41	1,26	1,13						
		Double	4,84	4,39	4,00	3,66	3,36	3,10	2,87	2,66	2,47	2,30	2,15	2,01	1,82	1,66	1,52
		Multiple	5,05	4,63	4,27	3,86	3,40	3,00	2,67	2,39	2,14	1,92	1,74	1,58	1,43	1,31	1,19
	Suction	Single	4,15	3,59	3,12	2,73	2,40	2,13	1,89	1,69	1,51						
		Double	4,84	4,39	4,00	3,66	3,36	3,10	2,87	2,66	2,47	2,30	2,15	2,02	1,89	1,78	1,68
		Multiple	6,06	5,49	5,00	4,58	4,20	3,88	3,57	3,19	2,86	2,58	2,33	2,11	1,92	1,75	1,60
1,50	Pressure	Single	3,77	3,26	2,83	2,48	2,18	1,93	1,72	1,53	1,37	1,24	1,12				
		Double	5,84	5,30	4,82	4,41	4,05	3,74	3,45	3,20	2,98	2,78	2,59	2,43	2,22	2,02	1,85
		Multiple	6,35	5,76	5,25	4,69	4,13	3,65	3,25	2,90	2,60	2,34	2,11	1,92	1,74	1,59	1,45
	Suction	Single	5,01	4,33	3,76	3,29	2,90	2,56	2,28	2,04	1,82	1,64	1,48				
		Double	5,84	5,30	4,82	4,41	4,05	3,74	3,45	3,20	2,98	2,78	2,59	2,43	2,28	2,14	2,02
		Multiple	7,30	6,62	6,03	5,52	5,07	4,67	4,31	3,85	3,45	3,11	2,81	2,54	2,31	2,11	1,93

pressure load - deflection limit L/200
suction load - deflection limit L/150
the load shown is the ultimate load divided by 1,5

APPLIED STANDARDS / NOTES

Tolerances/Coatings	EN 10143	Steel Quality	EN 10346	Handling	European Recommendations
Tests/Calculations	EN 1990, EN 1991 1-6, EN 1993 1-3, EN 1993 1-5 (Calculations are to Eurocode, however additional checks such as fixings are required)				
	Deck self weight has not been allowed for, so has to be included in applied loads				

JID 106-250-750

JID

Application:	Structural metal roof deck	Finishing:	Interior liner
Yield Stress (MPa):	320	Intermediate Support width:	≥160 mm
Ym:	1	End Support width:	≥40 mm

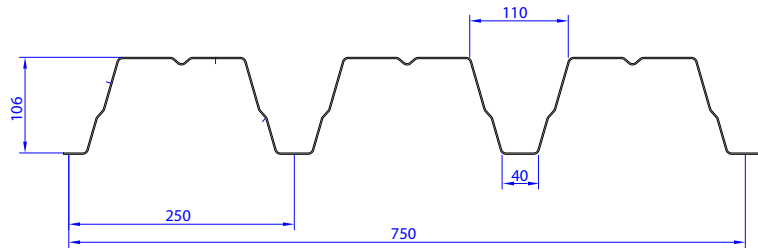

Mechanical Properties

tN [mm]	Weight (kg/m ²)	Broad flange in compression						Narrow flange in compression				
		Mc,Rk,F [kNm/m]	Mc,Rk,B [kNm/m]	Ieff [cm ⁴ /m]	Vw,Rk [kN/m]	Rw,Rk,B [kN/m]	Rw,Rk,A [kN/m]	Mc,Rk,F [kNm/m]	Mc,Rk,B [kNm/m]	Ieff [cm ⁴ /m]	Vw,Rk [kN/m]	Rw,Rk,A [kN/m]
0,75	9,81	7,99	7,65	169,55	47,89	36,55	10,88	7,65	7,99	175,29	47,89	47,89
0,88	11,51	10,50	9,52	194,30	77,54	50,36	15,16	9,52	10,50	211,53	77,54	77,54
1,00	13,08	12,55	11,20	228,44	102,82	64,69	19,65	11,20	12,55	241,67	102,82	102,82
1,25	16,35	17,11	14,68	302,12	160,45	99,13	30,61	14,68	17,11	304,43	160,45	160,45
1,50	19,62	21,99	17,71	367,11	230,03	139,46	43,67	17,71	21,99	367,11	230,03	230,03

Load type (kN/m²)

Thickness (mm)			Span (m)																
			4,40	4,60	4,80	5,00	5,20	5,40	5,60	5,80	6,00	6,20	6,40	6,60	6,80	7,00	7,20		
0,75	Pressure	Single	1,61	1,40	1,24														
		Double	2,20	2,01	1,85	1,70	1,58	1,46	1,36	1,27	1,18	1,11							
		Multiple	2,30	2,13	1,98	1,85	1,72	1,62	1,47	1,33	1,20								
	Suction	Single	2,11	1,93	1,70														
		Double	2,20	2,01	1,85	1,70	1,58	1,46	1,36	1,27	1,18	1,11							
		Multiple	2,75	2,52	2,31	2,13	1,97	1,83	1,70	1,58	1,48								
0,88	Pressure	Single	1,84	1,61	1,42	1,25	1,11												
		Double	2,89	2,65	2,43	2,24	2,07	1,92	1,79	1,66	1,56	1,46	1,37	1,29	1,20	1,10			
		Multiple	2,96	2,74	2,55	2,37	2,11	1,88	1,69	1,52	1,37	1,24	1,13						
	Suction	Single	2,62	2,34	2,06	1,82	1,62												
		Double	2,89	2,65	2,43	2,24	2,07	1,92	1,79	1,66	1,56	1,46	1,37	1,29	1,21	1,14			
		Multiple	3,61	3,31	3,04	2,80	2,59	2,40	2,23	2,08	1,94	1,80	1,64						
1,00	Pressure	Single	2,16	1,89	1,67	1,47	1,31	1,17											
		Double	3,46	3,16	2,90	2,68	2,48	2,30	2,13	1,99	1,86	1,74	1,63	1,54	1,41	1,29	1,19		
		Multiple	3,59	3,32	3,08	2,79	2,48	2,21	1,98	1,79	1,61	1,46	1,33	1,21	1,11				
	Suction	Single	3,05	2,67	2,35	2,08	1,85	1,65											
		Double	3,46	3,16	2,90	2,68	2,48	2,30	2,13	1,99	1,86	1,74	1,63	1,54	1,45	1,37	1,29		
		Multiple	4,32	3,95	3,63	3,35	3,09	2,87	2,67	2,49	2,28	2,06	1,87	1,71	1,56				
1,25	Pressure	Single	2,86	2,50	2,20	1,95	1,73	1,55	1,39	1,25	1,13								
		Double	4,71	4,31	3,96	3,65	3,37	3,13	2,91	2,71	2,53	2,37	2,23	2,04	1,87	1,71	1,57		
		Multiple	4,93	4,56	4,17	3,69	3,28	2,93	2,62	2,36	2,13	1,93	1,76	1,60	1,47	1,34	1,23		
	Suction	Single	3,84	3,36	2,96	2,62	2,33	2,08	1,86	1,68	1,52								
		Double	4,71	4,31	3,96	3,65	3,37	3,13	2,91	2,71	2,53	2,37	2,23	2,09	1,97	1,86	1,76		
		Multiple	5,89	5,39	4,95	4,56	4,22	3,91	3,53	3,17	2,87	2,60	2,36	2,15	1,97	1,80	1,66		
1,50	Pressure	Single	3,48	3,04	2,68	2,37	2,11	1,88	1,69	1,52	1,37	1,24	1,13						
		Double	6,06	5,54	5,09	4,69	4,34	4,02	3,74	3,49	3,26	2,99	2,72	2,48	2,27	2,08	1,91		
		Multiple	6,10	5,58	5,06	4,48	3,98	3,56	3,19	2,87	2,59	2,35	2,14	1,95	1,78	1,63	1,50		
	Suction	Single	4,63	4,06	3,57	3,16	2,81	2,51	2,25	2,02	1,83	1,66	1,51						
		Double	6,06	5,54	5,09	4,69	4,34	4,02	3,74	3,49	3,26	3,05	2,86	2,69	2,54	2,39	2,26		
		Multiple	7,57	6,93	6,36	5,86	5,31	4,74	4,25	3,83	3,46	3,13	2,85	2,60	2,37	2,18	2,00		

pressure load - deflection limit L/200
suction load - deflection limit L/150
the load shown is the ultimate load divided by 1,5

APPLIED STANDARDS / NOTES

Tolerances/Coatings	EN 10143	Steel Quality	EN 10346	Handling	European Recommendations
Tests/Calculations	EN 1990, EN 1991 1-6, EN 1993 1-3, EN 1993 1-5 (Calculations are to Eurocode, however additional checks such as fixings are required)				
	Deck self weight has not been allowed for, so has to be included in applied loads				

JID 106-250-750 Perfo Web (R5T8-DO)

JID

Application:	Structural metal roof deck	Finishing:	Interior liner
Yield Stress (MPa):	320	Intermediate Support width:	≥160 mm
Ym:	1	End Support width:	≥40 mm

■ = perforated zone

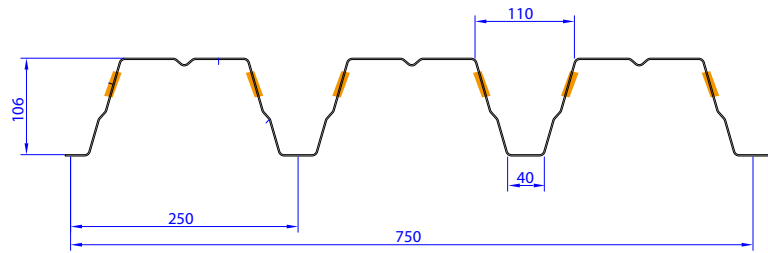

R5T8



Mechanical Properties

tN [mm]	Weight (kg/m ²)	Broad flange in compression						Narrow flange in compression				
		Mc,Rk,F [kNm/m]	Mc,Rk,B [kNm/m]	I _{eff} [cm ⁴ /m]	Vw,Rk [kN/m]	Rw,Rk,B [kN/m]	Rw,Rk,A [kN/m]	Mc,Rk,F [kNm/m]	Mc,Rk,B [kNm/m]	I _{eff} [cm ⁴ /m]	Vw,Rk [kN/m]	Rw,Rk,A [kN/m]
0,75	9,81	6,60	7,56	150,26	21,61	23,70	6,95	7,56	6,60	170,61	21,61	21,61
0,88	11,51	8,89	9,42	187,52	35,00	32,78	9,71	9,42	8,89	206,96	35,00	35,00
1,00	13,08	11,18	11,09	221,26	51,38	42,19	12,61	11,09	11,18	236,47	51,38	51,38
1,25	16,35	15,96	14,56	294,22	97,61	64,85	19,68	14,56	15,96	297,92	97,61	97,61
1,50	19,62	20,86	17,56	357,84	140,23	91,37	28,10	17,56	20,86	359,31	140,23	140,23

Load type (kN/m²)

Thickness (mm)			Span (m)														
			4,00	4,20	4,40	4,60	4,80	5,00	5,20	5,40	5,60	5,80	6,00	6,20	6,40	6,60	6,80
0,75	Pressure	Single	1,89	1,64	1,42	1,24	1,10										
		Double	2,20	2,00	1,82	1,66	1,53	1,41	1,30	1,21	1,12						
		Multiple	2,21	2,05	1,91	1,78	1,66	1,55	1,46	1,37	1,29	1,17					
	Suction	Single	2,52	2,29	2,08	1,88	1,66										
		Double	2,20	2,00	1,82	1,66	1,53	1,41	1,30	1,21	1,12						
		Multiple	2,75	2,49	2,27	2,08	1,91	1,76	1,63	1,51	1,40	1,31					
0,88	Pressure	Single	2,36	2,04	1,78	1,55	1,37	1,21									
		Double	2,96	2,69	2,45	2,24	2,06	1,90	1,75	1,63	1,51	1,41	1,32	1,23	1,16		
		Multiple	2,96	2,69	2,49	2,32	2,16	2,02	1,90	1,78	1,63	1,47	1,32	1,20			
	Suction	Single	3,14	2,85	2,60	2,29	2,01	1,78									
		Double	2,96	2,69	2,45	2,24	2,06	1,90	1,75	1,63	1,51	1,41	1,32	1,23	1,16		
		Multiple	3,70	3,36	3,06	2,80	2,57	2,37	2,19	2,03	1,89	1,76	1,65	1,54			
1,00	Pressure	Single	2,79	2,41	2,09	1,83	1,61	1,43	1,27	1,13							
		Double	3,73	3,38	3,08	2,82	2,59	2,39	2,21	2,05	1,90	1,77	1,66	1,55	1,46	1,37	1,29
		Multiple	3,73	3,38	3,08	2,83	2,64	2,47	2,31	2,14	1,92	1,73	1,56	1,42	1,29	1,17	
	Suction	Single	3,70	3,35	2,98	2,61	2,30	2,03	1,81	1,61							
		Double	3,73	3,38	3,08	2,82	2,59	2,39	2,21	2,05	1,90	1,77	1,66	1,55	1,46	1,37	1,29
		Multiple	4,66	4,23	3,85	3,52	3,24	2,98	2,76	2,56	2,38	2,22	2,07	1,94	1,82	1,67	
1,25	Pressure	Single	3,71	3,20	2,79	2,44	2,15	1,90	1,69	1,51	1,35	1,22	1,10				
		Double	5,32	4,83	4,40	4,02	3,70	3,41	3,15	2,92	2,71	2,53	2,36	2,21	2,08	1,95	1,82
		Multiple	5,32	4,83	4,40	4,02	3,70	3,43	3,19	2,85	2,56	2,30	2,08	1,88	1,71	1,56	1,43
	Suction	Single	4,85	4,32	3,76	3,29	2,90	2,56	2,28	2,03	1,82	1,64	1,48				
		Double	5,32	4,83	4,40	4,02	3,70	3,41	3,15	2,92	2,71	2,53	2,36	2,21	2,08	1,95	1,84
		Multiple	6,65	6,03	5,50	5,03	4,62	4,26	3,94	3,65	3,39	3,11	2,80	2,54	2,31	2,11	1,93
1,50	Pressure	Single	4,51	3,89	3,39	2,96	2,61	2,31	2,05	1,83	1,64	1,48	1,34	1,21	1,10		
		Double	6,95	6,31	5,75	5,26	4,83	4,45	4,12	3,82	3,55	3,31	3,09	2,89	2,65	2,42	2,21
		Multiple	6,95	6,31	5,75	5,26	4,83	4,37	3,88	3,47	3,11	2,80	2,53	2,29	2,08	1,90	1,74
	Suction	Single	5,85	5,21	4,54	3,97	3,49	3,09	2,75	2,45	2,20	1,98	1,79	1,62	1,47		
		Double	6,95	6,31	5,75	5,26	4,83	4,45	4,12	3,82	3,55	3,31	3,09	2,89	2,72	2,55	2,41
		Multiple	8,69	7,89	7,18	6,57	6,04	5,56	5,14	4,64	4,16	3,75	3,38	3,07	2,79	2,54	2,32

pressure load - deflection limit L/200
suction load - deflection limit L/150
the load shown is the ultimate load divided by 1,5

APPLIED STANDARDS / NOTES

Tolerances/Coatings	EN 10143	Steel Quality	EN 10346	Handling	European Recommendations
Tests/Calculations	EN 1990, EN 1991 1-6, EN 1993 1-3, EN 1993 1-5 (Calculations are to Eurocode, however additional checks such as fixings are required)				
	Deck self weight has not been allowed for, so has to be included in applied loads				

JID 137-310-930

JID

Application:	Structural metal roof deck	Finishing:	Interior liner
Yield Stress (MPa):	320	Intermediate Support width:	≥160 mm
Ym:	1	End Support width:	≥40 mm

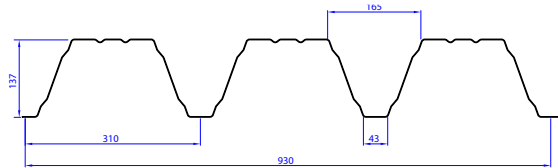

Section properties have been derived by testing according to Eurocode 3-1.3

Mechanical Properties

tN [mm]	Weight (kg/m ²)	Broad flange in compression										Narrow flange in compression					Residual support moment		
		Mc,Rk,F [kNm/m]	Mc,Rk,B [kNm/m]	MO,Rk,B [kNm/m]	I _{eff} [cm ⁴ /m]	Vw,Rk [kN/m]	Rw,Rk.B [kN/m]	RO,Rk.B [kN/m]	RG,w,Rk.A [kN/m]	RT,w,Rk.A [kN/m]	Mc,Rk,F [kNm/m]	Mc,Rk,B [kNm/m]	I _{eff} [cm ⁴ /m]	Vw,Rk [kN/m]	Rw,Rk.A [kN/m]	L _{min} [m]	L _{max} [m]	MR,Rk,max [kNm/m]	
0,75	9,50	9,66	8,17	11,21	286,00	28,49	22,82	25,97	7,14	9,86	8,30	9,66	276,30	28,49	28,49	5,29	6,01	2,23	
0,88	11,14	12,57	11,56	15,13	338,30	45,43	31,51	35,73	10,60	14,28	10,90	12,26	335,60	45,43	45,43	5,16	5,89	3,03	
1,00	12,66	15,39	14,69	18,75	386,60	65,91	39,53	44,74	13,80	18,35	13,43	14,77	386,60	65,91	65,91	5,05	5,77	3,78	
1,25	15,83	22,42	20,75	23,66	487,00	121,14	62,71	78,27	21,80	26,79	18,55	20,23	487,00	121,14	121,14	4,62	5,36	6,01	
1,50	18,99	27,05	25,04	28,55	587,40	173,22	75,67	94,44	26,30	32,32	22,54	26,11	587,40	173,22	173,22	4,62	5,36	7,25	

Load type (kN/m²)

Thickness (mm)			Span (m)															
			4,60	4,80	5,00	5,20	5,40	5,60	5,80	6,00	6,20	6,40	6,60	6,80	7,00	7,20	7,40	
0,75	Pressure	Single	2,37	2,09	1,85	1,64	1,46	1,31	1,18									
		Double	2,43	2,24	2,06	1,91	1,80	1,72	1,65	1,59	1,49	1,40	1,32	1,24	1,17	1,11		
		Multiple	2,43	2,24	2,06	1,91	1,80	1,72	1,65	1,59	1,49	1,40	1,32	1,24	1,17	1,11		
	Suction	Single	2,09	1,92	1,77	1,58	1,41	1,27	1,14									
		Double	2,43	2,24	2,06	1,91	1,77	1,64	1,53	1,43	1,34	1,26	1,18	1,11	1,05	0,99		
		Multiple	3,04	2,80	2,58	2,38	2,21	2,05	1,91	1,79	1,68	1,57	1,47	1,34	1,23	1,13		
0,88	Pressure	Single	2,80	2,47	2,18	1,94	1,73	1,55	1,40	1,26	1,14							
		Double	3,17	2,91	2,68	2,50	2,39	2,29	2,20	2,08	1,95	1,83	1,72	1,62	1,53	1,44	1,37	
		Multiple	3,17	2,91	2,68	2,50	2,39	2,29	2,20	2,08	1,95	1,83	1,72	1,62	1,50	1,38	1,27	
	Suction	Single	2,75	2,45	2,17	1,92	1,72	1,54	1,39	1,25	1,14							
		Double	3,09	2,84	2,62	2,42	2,24	2,09	1,94	1,82	1,70	1,60	1,50	1,41	1,33	1,26	1,19	
		Multiple	3,86	3,55	3,27	3,02	2,80	2,61	2,43	2,27	2,13	1,95	1,78	1,63	1,49	1,37	1,26	
1,00	Pressure	Single	3,20	2,82	2,49	2,22	1,98	1,78	1,60	1,44	1,31	1,19						
		Double	3,88	3,56	3,28	3,11	2,98	2,86	2,73	2,55	2,39	2,24	2,11	1,99	1,88	1,77	1,68	
		Multiple	3,88	3,56	3,28	3,11	2,98	2,86	2,73	2,55	2,39	2,24	2,05	1,88	1,72	1,58	1,46	
	Suction	Single	3,20	2,82	2,49	2,22	1,98	1,78	1,60	1,44	1,31	1,19						
		Double	3,72	3,42	3,15	2,91	2,70	2,51	2,34	2,19	2,05	1,92	1,81	1,70	1,61	1,52	1,44	
		Multiple	4,65	4,27	3,94	3,64	3,38	3,14	2,93	2,73	2,47	2,25	2,05	1,88	1,72	1,58	1,46	
1,25	Pressure	Single	4,03	3,55	3,14	2,79	2,49	2,24	2,01	1,82	1,65	1,50	1,37	1,25	1,14	1,05		
		Double	5,65	5,36	5,11	4,88	4,63	4,31	4,02	3,75	3,52	3,30	3,10	2,92	2,76	2,53	2,33	
		Multiple	5,65	5,36	5,11	4,88	4,63	4,23	3,81	3,44	3,12	2,83	2,58	2,36	2,17	1,99	1,83	
	Suction	Single	4,03	3,55	3,14	2,79	2,49	2,24	2,01	1,82	1,65	1,50	1,37	1,25	1,14	1,05		
		Double	5,10	4,68	4,32	3,99	3,70	3,44	3,21	3,00	2,81	2,63	2,48	2,33	2,20	2,08	1,97	
		Multiple	6,37	5,85	5,39	4,99	4,63	4,23	3,81	3,44	3,12	2,83	2,58	2,36	2,17	1,99	1,83	
1,50	Pressure	Single	4,87	4,28	3,79	3,37	3,01	2,70	2,43	2,19	1,99	1,81	1,65	1,51	1,38	1,27	1,17	
		Double	6,82	6,46	6,16	5,88	5,59	5,20	4,85	4,53	4,24	3,98	3,74	3,53	3,33	3,06	2,82	
		Multiple	6,82	6,46	6,16	5,88	5,59	5,10	4,59	4,15	3,76	3,42	3,12	2,85	2,61	2,40	2,21	
	Suction	Single	4,87	4,28	3,79	3,37	3,01	2,70	2,43	2,19	1,99	1,81	1,65	1,51	1,38	1,27	1,17	
		Double	6,58	6,04	5,57	5,15	4,78	4,44	4,14	3,87	3,62	3,40	3,20	3,01	2,84	2,69	2,54	
		Multiple	8,23	7,55	6,96	6,37	5,69	5,10	4,59	4,15	3,76	3,42	3,12	2,85	2,61	2,40	2,21	

pressure load - deflection limit L/200
suction load - deflection limit L/150
the load shown is the ultimate load divided by 1,5

APPLIED STANDARDS / NOTES

Tolerances/Coatings	EN 10143	Steel Quality	EN 10346	Handling	European Recommendations
Tests/Calculations	EN 1990, EN 1991 1-6, EN 1993 1-3, EN 1993 1-5 (Calculations are to Eurocode, however additional checks such as fixings are required)				
	Deck self weight has not been allowed for, so has to be included in applied loads				

JID 137-310-930 Perfo Web (R5T8-DO)

JID

Application:	Structural metal roof deck	Finishing:	Interior liner
Yield Stress (MPa):	320	Intermediate Support width:	≥160 mm
Ym:	1	End Support width:	≥40 mm

 = perforated zone

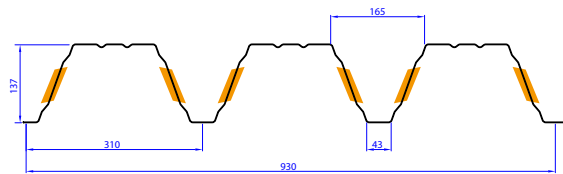

R5T8



Section properties have been derived by testing according to Eurocode 3-1.3

Mechanical Properties

tN [mm]	Weight (kg/m ²)	Broad flange in compression										Narrow flange in compression				Residual support moment		
		Mc,Rk,F [kNm/m]	Mc,Rk,B [kNm/m]	MO,Rk,B [kNm/m]	I _{eff} [cm ⁴ /m]	Vw,Rk [kN/m]	Rw,Rk.B [kN/m]	RO,Rk.B [kN/m]	RG,w,Rk.A [kN/m]	RT,w,Rk.A [kN/m]	Mc,Rk,F [kNm/m]	Mc,Rk,B [kNm/m]	I _{eff} [cm ⁴ /m]	Vw,Rk [kN/m]	Rw,Rk.A [kN/m]	L _{min} [m]	L _{max} [m]	MR,Rk,max [kNm/m]
0,75	9,50	8,24	6,77	9,20	258,80	12,47	16,43	20,77	5,55	7,72	7,82	9,40	256,30	12,47	12,47	5,96	6,95	2,23
0,88	11,14	10,89	9,55	12,36	312,90	19,94	22,58	28,74	8,16	10,66	10,13	11,99	314,60	19,94	19,94	5,70	6,70	3,12
1,00	12,66	13,34	12,13	15,29	359,50	28,99	28,26	36,09	10,56	13,38	12,39	14,48	364,50	28,99	28,99	5,46	6,47	3,94
1,25	15,83	18,48	17,31	20,15	453,00	55,60	43,22	58,21	15,59	20,58	16,72	19,75	459,20	55,60	55,60	4,77	5,81	6,23
1,50	18,99	22,30	20,88	24,31	546,30	94,60	52,14	70,24	18,81	24,83	20,34	24,57	553,80	94,60	94,60	4,77	5,81	7,52

Load type (kN/m²)

Thickness (mm)			Span (m)															
			4,00	4,20	4,40	4,60	4,80	5,00	5,20	5,40	5,60	5,80	6,00	6,20	6,40	6,60	6,80	
0,75	Pressure	Single	2,57	2,45	2,27	2,08	1,89	1,67	1,48	1,33	1,19							
		Double	2,49	2,32	2,17	2,03	1,91	1,76	1,63	1,51	1,40	1,31	1,23	1,18	1,14	1,10		
		Multiple	2,57	2,45	2,27	2,08	1,91	1,76	1,63	1,51	1,40	1,31	1,23	1,18	1,14	1,10		
	Suction	Single	2,61	2,36	2,15	1,97	1,81	1,65	1,47	1,31	1,18							
		Double	2,44	2,28	2,14	2,01	1,89	1,78	1,68	1,58	1,49	1,41	1,33	1,26	1,20	1,13		
		Multiple	2,87	2,69	2,52	2,37	2,24	2,11	2,00	1,89	1,79	1,69	1,61	1,53	1,45	1,36		
0,88	Pressure	Single	3,55	3,29	2,96	2,59	2,28	2,02	1,79	1,60	1,44	1,29	1,17					
		Double	3,40	3,17	2,96	2,74	2,52	2,32	2,15	1,99	1,85	1,75	1,68	1,62	1,56	1,50	1,43	
		Multiple	3,55	3,29	3,00	2,74	2,52	2,32	2,15	1,99	1,85	1,75	1,68	1,62	1,56	1,50	1,43	
	Suction	Single	3,38	3,06	2,79	2,55	2,29	2,03	1,80	1,61	1,44	1,30	1,17					
		Double	3,55	3,30	3,07	2,86	2,66	2,49	2,32	2,17	2,03	1,90	1,78	1,66	1,56	1,47	1,38	
		Multiple	4,22	3,93	3,67	3,43	3,21	3,01	2,82	2,65	2,49	2,34	2,20	2,01	1,83	1,67	1,53	
1,00	Pressure	Single	4,45	3,91	3,40	2,98	2,62	2,32	2,06	1,84	1,65	1,49	1,34	1,22	1,11			
		Double	4,24	3,95	3,67	3,36	3,09	2,85	2,63	2,44	2,31	2,22	2,13	2,05	1,97	1,87	1,76	
		Multiple	4,45	4,03	3,67	3,36	3,09	2,85	2,63	2,44	2,31	2,22	2,13	2,05	1,97	1,87	1,74	
	Suction	Single	4,13	3,75	3,41	3,02	2,66	2,35	2,09	1,87	1,67	1,51	1,36	1,23	1,12			
		Double	4,64	4,27	3,93	3,63	3,35	3,09	2,86	2,65	2,46	2,30	2,15	2,01	1,89	1,77	1,67	
		Multiple	5,59	5,17	4,79	4,44	4,12	3,83	3,56	3,31	3,08	2,85	2,57	2,33	2,12	1,93	1,77	
1,25	Pressure	Single	5,71	4,93	4,29	3,75	3,30	2,92	2,60	2,32	2,08	1,87	1,69	1,53	1,39	1,27	1,16	
		Double	6,16	5,59	5,09	4,66	4,30	4,09	3,89	3,72	3,55	3,40	3,18	2,98	2,80	2,63	2,48	
		Multiple	6,16	5,59	5,09	4,66	4,30	4,09	3,89	3,72	3,55	3,40	3,18	2,90	2,64	2,40	2,20	
	Suction	Single	5,57	5,00	4,35	3,80	3,35	2,96	2,63	2,35	2,11	1,90	1,71	1,55	1,41	1,29	1,18	
		Double	6,58	5,97	5,44	4,98	4,57	4,21	3,90	3,61	3,36	3,13	2,93	2,74	2,57	2,42	2,28	
		Multiple	8,23	7,46	6,80	6,22	5,71	5,27	4,87	4,45	3,99	3,59	3,24	2,94	2,67	2,44	2,23	
1,50	Pressure	Single	6,88	5,95	5,17	4,53	3,98	3,52	3,13	2,80	2,51	2,26	2,04	1,85	1,68	1,53	1,40	
		Double	7,43	6,74	6,14	5,62	5,19	4,93	4,70	4,49	4,29	4,10	3,84	3,60	3,38	3,17	2,99	
		Multiple	7,43	6,74	6,14	5,62	5,19	4,93	4,70	4,49	4,29	4,10	3,84	3,50	3,18	2,90	2,65	
	Suction	Single	6,78	6,03	5,24	4,59	4,04	3,57	3,18	2,84	2,54	2,29	2,07	1,87	1,70	1,55	1,42	
		Double	8,19	7,43	6,77	6,19	5,69	5,24	4,85	4,49	4,18	3,90	3,64	3,41	3,20	3,01	2,83	
		Multiple	10,24	9,29	8,46	7,74	7,11	6,55	6,01	5,36	4,81	4,33	3,91	3,54	3,22	2,94	2,69	

pressure load - deflection limit L/200
suction load - deflection limit L/150
the load shown is the ultimate load divided by 1,5

APPLIED STANDARDS / NOTES

Tolerances/Coatings	EN 10143	Steel Quality	EN 10346	Handling	European Recommendations
Tests/Calculations	EN 1990, EN 1991 1-6, EN 1993 1-3, EN 1993 1-5 (Calculations are to Eurocode, however additional checks such as fixings are required)				
	Deck self weight has not been allowed for, so has to be included in applied loads				

JID 153-280-840

JID

Application:	Structural metal roof deck	Finishing:	Interior liner
Yield Stress (MPa):	320	Intermediate Support width:	≥160 mm
Ym:	1	End Support width:	≥40 mm

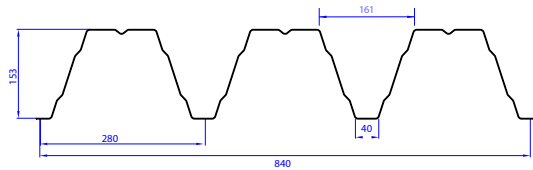

Section properties have been derived by testing according to Eurocode 3-1.3

Mechanical Properties

tN [mm]	Weight (kg/m ²)	Broad flange in compression										Narrow flange in compression					Residual support moment		
		Mc,Rk,F [kNm/m]	Mc,Rk,B [kNm/m]	MO,Rk,B [kNm/m]	Ieff [cm ⁴ /m]	Vw,Rk [kN/m]	Rw,Rk.B [kN/m]	RO,Rk.B [kN/m]	RG,w,Rk.A [kN/m]	RT,w,Rk.A [kN/m]	Mc,Rk,F [kNm/m]	Mc,Rk,B [kNm/m]	Ieff [cm ⁴ /m]	Vw,Rk [kN/m]	Rw,Rk.A [kN/m]	Lmin [m]	Lmax [m]	MR,Rk,max [kNm/m]	
0,75	10,51	13,21	10,62	14,13	375,10	29,29	31,87	32,49	10,07	10,99	11,06	13,21	367,80	29,29	29,29	4,43	5,18	3,69	
0,88	12,34	18,48	14,61	18,01	443,70	47,22	41,32	47,79	14,33	15,42	14,07	16,54	443,70	47,22	47,22	4,93	5,66	4,56	
1,00	14,02	23,34	18,30	21,60	507,00	68,81	50,03	61,92	18,25	19,50	17,29	19,74	507,00	68,81	68,81	5,39	6,10	5,37	
1,25	17,52	31,28	25,78	28,18	638,70	131,57	83,11	109,46	28,10	28,10	22,90	26,52	638,70	131,57	131,57	4,12	4,88	9,39	
1,50	21,03	37,75	31,11	34,01	770,30	196,90	100,29	132,08	33,91	33,91	27,62	33,24	770,30	196,90	196,90	4,12	4,88	11,34	

Load type (kN/m²)

Thickness (mm)			Span (m)																
			5,40	5,60	5,80	6,00	6,20	6,40	6,60	6,80	7,00	7,20	7,40	7,60	7,80	8,00	8,20		
0,75	Pressure	Single	1,92	1,72	1,55	1,40	1,27	1,15											
		Double	2,47	2,33	2,21	2,09	1,99	1,89	1,80	1,71	1,63	1,54	1,46	1,38	1,31	1,25	1,19		
		Multiple	2,71	2,55	2,38	2,22	2,08	1,95	1,84	1,73	1,63	1,53	1,41	1,30	1,21	1,12			
	Suction	Single	1,88	1,69	1,52	1,37	1,24	1,13											
		Double	2,42	2,25	2,09	1,96	1,83	1,72	1,62	1,52	1,44	1,36	1,29	1,22	1,16	1,10	1,05		
		Multiple	3,02	2,81	2,62	2,45	2,29	2,14	1,95	1,78	1,64	1,50	1,38	1,28	1,18	1,10			
0,88	Pressure	Single	2,27	2,04	1,83	1,66	1,50	1,36	1,24	1,14									
		Double	3,34	3,15	2,98	2,82	2,67	2,53	2,41	2,29	2,18	2,08	1,98	1,89	1,81	1,68	1,56		
		Multiple	3,64	3,49	3,28	3,07	2,84	2,58	2,35	2,15	1,97	1,81	1,67	1,54	1,43	1,32	1,23		
	Suction	Single	2,27	2,04	1,83	1,66	1,50	1,36	1,24	1,14									
		Double	3,03	2,81	2,62	2,45	2,29	2,15	2,03	1,91	1,80	1,70	1,61	1,53	1,45	1,38	1,31		
		Multiple	3,78	3,52	3,28	3,06	2,84	2,58	2,35	2,15	1,97	1,81	1,67	1,54	1,43	1,32	1,23		
1,00	Pressure	Single	2,60	2,33	2,10	1,89	1,72	1,56	1,42	1,30	1,19	1,10							
		Double	4,13	3,89	3,67	3,47	3,29	3,11	2,96	2,81	2,67	2,54	2,43	2,24	2,08	1,92	1,79		
		Multiple	4,28	4,10	3,94	3,58	3,24	2,95	2,69	2,46	2,25	2,07	1,91	1,76	1,63	1,51	1,40		
	Suction	Single	2,60	2,33	2,10	1,89	1,72	1,56	1,42	1,30	1,19	1,10							
		Double	3,61	3,36	3,13	2,92	2,74	2,57	2,42	2,28	2,15	2,03	1,92	1,82	1,73	1,65	1,57		
		Multiple	4,51	4,20	3,91	3,58	3,24	2,95	2,69	2,46	2,25	2,07	1,91	1,76	1,63	1,51	1,40		
1,25	Pressure	Single	3,27	2,93	2,64	2,38	2,16	1,96	1,79	1,64	1,50	1,38	1,27	1,17					
		Double	5,93	5,56	5,23	4,92	4,64	4,39	4,15	3,93	3,62	3,32	3,06	2,83	2,61	2,42	2,25		
		Multiple	6,19	5,55	4,99	4,51	4,09	3,72	3,39	3,10	2,84	2,61	2,40	2,22	2,05	1,90	1,77		
	Suction	Single	3,27	2,93	2,64	2,38	2,16	1,96	1,79	1,64	1,50	1,38	1,27	1,17					
		Double	4,85	4,51	4,20	3,93	3,68	3,45	3,25	3,06	2,89	2,73	2,58	2,45	2,32	2,21	2,10		
		Multiple	6,06	5,55	4,99	4,51	4,09	3,72	3,39	3,10	2,84	2,61	2,40	2,22	2,05	1,90	1,77		
1,50	Pressure	Single	3,94	3,54	3,18	2,88	2,61	2,37	2,16	1,98	1,81	1,66	1,53	1,42	1,31	1,21	1,13		
		Double	7,15	6,71	6,31	5,94	5,60	5,30	5,01	4,75	4,36	4,01	3,69	3,41	3,15	2,92	2,71		
		Multiple	7,46	6,69	6,02	5,44	4,93	4,48	4,09	3,74	3,43	3,15	2,90	2,68	2,48	2,29	2,13		
	Suction	Single	3,94	3,54	3,18	2,88	2,61	2,37	2,16	1,98	1,81	1,66	1,53	1,42	1,31	1,21	1,13		
		Double	6,08	5,65	5,27	4,92	4,61	4,33	4,07	3,83	3,62	3,42	3,24	3,07	2,91	2,77	2,64		
		Multiple	7,46	6,69	6,02	5,44	4,93	4,48	4,09	3,74	3,43	3,15	2,90	2,68	2,48	2,29	2,13		

pressure load - deflection limit L/200
suction load - deflection limit L/150
the load shown is the ultimate load divided by 1,5

APPLIED STANDARDS / NOTES

Tolerances/Coatings	EN 10143	Steel Quality	EN 10346	Handling	European Recommendations
Tests/Calculations	EN 1990, EN 1991 1-6, EN 1993 1-3, EN 1993 1-5 (Calculations are to Eurocode, however additional checks such as fixings are required)				
Deck self weight has not been allowed for, so has to be included in applied loads					

JID 153-280-840 Perfo Web (R5T8-DO)

JID

Application:	Structural metal roof deck	Finishing:	Interior liner
Yield Stress (MPa):	320	Intermediate Support width:	≥160 mm
Ym:	1	End Support width:	≥40 mm

■ = perforated zone

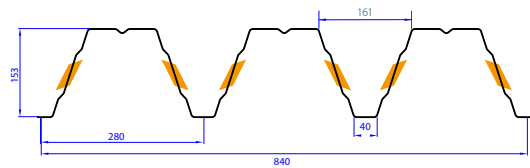

R5T8



Section properties have been derived by testing according to Eurocode 3-1.3

Mechanical Properties

tN [mm]	Weight (kg/m ²)	Broad flange in compression										Narrow flange in compression				Residual support moment		
		Mc,Rk,F [kNm/m]	Mc,Rk,B [kNm/m]	MO,Rk,B [kNm/m]	Ieff [cm ⁴ /m]	Vw,Rk [kN/m]	Rw,Rk.B [kN/m]	RO,Rk.B [kN/m]	RG,w,Rk.A [kN/m]	RT,w,Rk.A [kN/m]	Mc,Rk,F [kNm/m]	Mc,Rk,B [kNm/m]	Ieff [cm ⁴ /m]	Vw,Rk [kN/m]	Rw,Rk.A [kN/m]	Lmin [m]	Lmax [m]	MR,Rk,max [kNm/m]
0,75	10,51	12,20	9,46	11,68	365,80	13,36	24,34	29,58	7,99	7,99	10,29	13,04	353,40	13,36	13,36	6,85	7,82	2,82
0,88	12,34	17,27	13,40	15,68	423,10	21,53	33,35	44,30	11,60	11,60	13,34	16,33	428,70	21,53	21,53	7,69	8,64	3,49
1,00	14,02	21,95	17,03	19,37	491,00	31,49	41,68	57,89	14,94	14,94	16,30	19,46	489,90	31,49	31,49	8,45	9,39	4,10
1,25	17,52	30,02	24,33	26,81	625,90	60,63	61,71	88,63	23,59	23,59	21,38	25,97	617,20	60,63	60,63	8,00	8,94	5,94
1,50	21,03	36,22	29,36	32,35	754,90	103,16	74,46	106,94	28,46	28,46	25,79	32,26	744,30	103,16	103,16	8,00	8,94	7,16

Load type (kN/m²)

Thickness (mm)			Span (m)															
			5,00	5,20	5,40	5,60	5,80	6,00	6,20	6,40	6,60	6,80	7,00	7,20	7,40	7,60	7,80	
0,75	Pressure	Single	2,13	2,05	1,87	1,68	1,51	1,37	1,24	1,13								
		Double	2,13	2,05	1,97	1,90	1,84	1,78	1,69	1,59	1,49	1,41	1,35	1,31	1,26	1,21	1,16	
		Multiple	2,13	2,05	1,97	1,90	1,84	1,78	1,69	1,59	1,49	1,41	1,35	1,31	1,26	1,23	1,18	
	Suction	Single	2,20	2,03	1,81	1,62	1,46	1,32	1,20	1,09								
		Double	2,12	2,01	1,91	1,81	1,73	1,65	1,57	1,50	1,43	1,37	1,31	1,25	1,20	1,15	1,10	
		Multiple	2,48	2,36	2,24	2,14	2,04	1,94	1,86	1,78	1,70	1,63	1,56	1,44	1,33	1,23	1,14	
0,88	Pressure	Single	2,73	2,43	2,17	1,94	1,75	1,58	1,43	1,30	1,19							
		Double	3,09	2,97	2,86	2,76	2,65	2,51	2,37	2,25	2,11	1,99	1,88	1,78	1,68	1,59	1,53	
		Multiple	3,09	2,97	2,86	2,76	2,67	2,56	2,40	2,25	2,11	1,99	1,88	1,73	1,59	1,47	1,36	
	Suction	Single	2,77	2,46	2,20	1,97	1,77	1,60	1,45	1,32	1,20							
		Double	3,08	2,90	2,74	2,59	2,45	2,31	2,19	2,07	1,97	1,86	1,77	1,68	1,59	1,51	1,43	
		Multiple	3,66	3,45	3,27	3,10	2,94	2,79	2,65	2,49	2,27	2,08	1,91	1,75	1,61	1,49	1,38	
1,00	Pressure	Single	3,17	2,82	2,51	2,25	2,03	1,83	1,66	1,51	1,38	1,26	1,15					
		Double	3,98	3,83	3,69	3,54	3,34	3,15	2,98	2,83	2,68	2,53	2,39	2,26	2,14	2,03	1,92	
		Multiple	3,98	3,83	3,69	3,56	3,43	3,25	3,05	2,86	2,60	2,38	2,18	2,01	1,85	1,71	1,58	
	Suction	Single	3,16	2,81	2,51	2,25	2,02	1,83	1,66	1,51	1,37	1,26	1,15					
		Double	4,00	3,74	3,50	3,28	3,07	2,88	2,70	2,53	2,38	2,24	2,12	2,00	1,90	1,80	1,71	
		Multiple	4,83	4,53	4,26	4,01	3,77	3,46	3,14	2,85	2,60	2,38	2,18	2,00	1,84	1,70	1,57	
1,25	Pressure	Single	4,04	3,59	3,21	2,87	2,59	2,34	2,12	1,93	1,76	1,61	1,47	1,35	1,25	1,15		
		Double	6,12	5,74	5,38	5,06	4,76	4,45	4,17	3,91	3,68	3,46	3,27	3,09	2,92	2,77	2,56	
		Multiple	6,29	5,92	5,49	5,11	4,76	4,42	4,01	3,64	3,32	3,04	2,78	2,56	2,36	2,17	2,01	
	Suction	Single	3,98	3,54	3,16	2,83	2,55	2,30	2,09	1,90	1,73	1,58	1,45	1,33	1,23	1,13		
		Double	5,54	5,12	4,75	4,42	4,12	3,85	3,60	3,38	3,18	3,00	2,83	2,67	2,53	2,40	2,28	
		Multiple	6,93	6,40	5,94	5,36	4,82	4,36	3,95	3,59	3,27	2,99	2,74	2,52	2,32	2,14	1,98	
1,50	Pressure	Single	4,87	4,33	3,87	3,47	3,12	2,82	2,55	2,32	2,12	1,94	1,77	1,63	1,50	1,39	1,28	
		Double	7,39	6,92	6,50	6,11	5,74	5,37	5,03	4,72	4,43	4,18	3,94	3,73	3,53	3,34	3,09	
		Multiple	7,59	7,14	6,62	6,16	5,74	5,33	4,83	4,39	4,00	3,66	3,36	3,08	2,84	2,62	2,43	
	Suction	Single	4,80	4,27	3,81	3,42	3,08	2,78	2,52	2,29	2,09	1,91	1,75	1,61	1,48	1,37	1,26	
		Double	6,88	6,36	5,90	5,49	5,11	4,78	4,48	4,20	3,95	3,72	3,51	3,32	3,14	2,98	2,83	
		Multiple	8,60	7,95	7,21	6,46	5,82	5,26	4,76	4,33	3,95	3,61	3,31	3,04	2,80	2,59	2,39	

pressure load - deflection limit L/200
suction load - deflection limit L/150
the load shown is the ultimate load divided by 1,5

APPLIED STANDARDS / NOTES

Tolerances/Coatings	EN 10143	Steel Quality	EN 10346	Handling	European Recommendations
Tests/Calculations	EN 1990, EN 1991 1-6, EN 1993 1-3, EN 1993 1-5 (Calculations are to Eurocode, however additional checks such as fixings are required)				
	Deck self weight has not been allowed for, so has to be included in applied loads				

JID 158-250-750

JID

Application:	Structural metal roof deck	Finishing:	Interior liner
Yield Stress (MPa):	320	Intermediate Support width:	≥160 mm
Ym:	1	End Support width:	≥40 mm

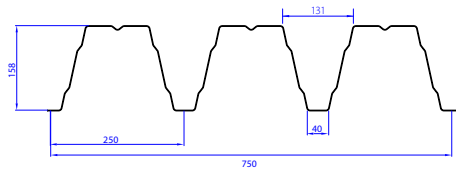

Section properties have been derived by testing according to Eurocode 3-1.3

Mechanical Properties

tN [mm]	Weight (kg/m ²)	Broad flange in compression										Narrow flange in compression					Residual support moment		
		Mc,Rk,F [kNm/m]	Mc,Rk,B [kNm/m]	MO,Rk,B [kNm/m]	I _{eff} [cm ⁴ /m]	Vw,Rk [kN/m]	Rw,Rk.B [kN/m]	RO,Rk.B [kN/m]	RG,w,Rk.A [kN/m]	RT,w,Rk.A [kN/m]	Mc,Rk,F [kNm/m]	Mc,Rk,B [kNm/m]	I _{eff} [cm ⁴ /m]	Vw,Rk [kN/m]	Rw,Rk.A [kN/m]	L _{min} [m]	L _{max} [m]	MR,Rk,max [kNm/m]	
0,75	11,78	15,27	12,83	16,63	446,00	34,04	37,59	37,97	11,26	12,70	12,78	15,24	438,00	34,04	34,04	4,12	4,87	4,59	
0,88	13,82	20,58	16,85	19,98	527,60	54,87	49,39	58,42	16,81	17,64	16,24	19,08	527,60	54,87	54,87	4,07	4,83	6,27	
1,00	15,70	25,49	20,56	23,06	597,60	79,95	60,29	77,30	21,94	22,19	19,96	22,76	602,80	79,95	79,95	4,03	4,79	7,82	
1,25	19,63	35,89	28,51	30,97	759,30	152,86	88,99	117,95	31,89	31,89	26,34	30,58	759,30	152,86	152,86	3,87	4,63	11,47	
1,50	23,55	43,31	34,40	37,37	915,60	227,93	107,38	142,32	38,48	38,48	31,76	38,31	915,60	227,93	227,93	3,87	4,63	13,84	

Load type (kN/m²)

Thickness (mm)			Span (m)															
			6,00	6,20	6,40	6,60	6,80	7,00	7,20	7,40	7,60	7,80	8,00	8,20	8,40	8,60	8,80	
0,75	Pressure	Single	1,67	1,51	1,37	1,25	1,14											
		Double	2,46	2,33	2,22	2,11	2,01	1,90	1,80	1,70	1,61	1,53	1,46	1,39	1,32	1,26	1,20	
		Multiple	2,59	2,43	2,28	2,14	2,02	1,90	1,80	1,68	1,55	1,43	1,33	1,23	1,15			
	Suction	Single	1,64	1,48	1,35	1,23	1,12											
		Double	2,26	2,11	1,98	1,87	1,76	1,66	1,57	1,48	1,41	1,34	1,27	1,21	1,15	1,10	1,05	
		Multiple	2,82	2,64	2,48	2,32	2,12	1,95	1,79	1,65	1,52	1,41	1,30	1,21	1,13			
0,88	Pressure	Single	1,97	1,79	1,62	1,48	1,35	1,24	1,14									
		Double	3,23	3,06	2,90	2,75	2,61	2,48	2,37	2,25	2,15	2,06	1,97	1,86	1,73	1,61	1,50	
		Multiple	3,50	3,28	3,07	2,80	2,56	2,35	2,16	1,99	1,83	1,70	1,57	1,46	1,36	1,27	1,18	
	Suction	Single	1,97	1,79	1,62	1,48	1,35	1,24	1,14									
		Double	2,83	2,65	2,48	2,34	2,20	2,08	1,96	1,86	1,76	1,67	1,59	1,51	1,44	1,38	1,31	
		Multiple	3,53	3,31	3,07	2,80	2,56	2,35	2,16	1,99	1,83	1,70	1,57	1,46	1,36	1,27	1,18	
1,00	Pressure	Single	2,23	2,02	1,84	1,68	1,53	1,40	1,29	1,19	1,10							
		Double	3,88	3,67	3,47	3,29	3,12	2,96	2,82	2,68	2,56	2,44	2,27	2,11	1,96	1,83	1,70	
		Multiple	4,22	3,82	3,48	3,17	2,90	2,66	2,44	2,25	2,08	1,92	1,78	1,65	1,54	1,43	1,34	
	Suction	Single	2,25	2,04	1,85	1,69	1,55	1,42	1,30	1,20	1,11							
		Double	3,37	3,16	2,96	2,79	2,63	2,48	2,34	2,22	2,10	2,00	1,90	1,81	1,72	1,64	1,57	
		Multiple	4,21	3,86	3,51	3,20	2,92	2,68	2,46	2,27	2,09	1,94	1,80	1,67	1,55	1,45	1,35	
1,25	Pressure	Single	2,83	2,57	2,34	2,13	1,95	1,79	1,64	1,51	1,39	1,29	1,20	1,11				
		Double	5,39	5,08	4,80	4,54	4,31	4,09	3,88	3,64	3,36	3,11	2,88	2,68	2,49	2,32	2,16	
		Multiple	5,36	4,86	4,42	4,03	3,68	3,38	3,10	2,86	2,64	2,44	2,26	2,10	1,95	1,82	1,70	
	Suction	Single	2,83	2,57	2,34	2,13	1,95	1,79	1,64	1,51	1,39	1,29	1,20	1,11				
		Double	4,53	4,24	3,98	3,74	3,53	3,33	3,15	2,98	2,82	2,68	2,55	2,43	2,31	2,21	2,11	
		Multiple	5,36	4,86	4,42	4,03	3,68	3,38	3,10	2,86	2,64	2,44	2,26	2,10	1,95	1,82	1,70	
1,50	Pressure	Single	3,42	3,10	2,82	2,57	2,35	2,15	1,98	1,82	1,68	1,56	1,44	1,34	1,25	1,16		
		Double	6,50	6,13	5,79	5,48	5,20	4,93	4,68	4,39	4,05	3,75	3,47	3,23	3,00	2,80	2,61	
		Multiple	6,47	5,86	5,33	4,86	4,44	4,07	3,74	3,45	3,18	2,94	2,73	2,53	2,36	2,20	2,05	
	Suction	Single	3,42	3,10	2,82	2,57	2,35	2,15	1,98	1,82	1,68	1,56	1,44	1,34	1,25	1,16		
		Double	5,68	5,32	4,99	4,69	4,42	4,17	3,94	3,73	3,54	3,36	3,19	3,04	2,90	2,76	2,61	
		Multiple	6,47	5,86	5,33	4,86	4,44	4,07	3,74	3,45	3,18	2,94	2,73	2,53	2,36	2,20	2,05	

pressure load - deflection limit L/200
suction load - deflection limit L/150
the load shown is the ultimate load divided by 1,5

APPLIED STANDARDS / NOTES

Tolerances/Coatings	EN 10143	Steel Quality	EN 10346	Handling	European Recommendations
Tests/Calculations	EN 1990, EN 1991 1-6, EN 1993 1-3, EN 1993 1-5 (Calculations are to Eurocode, however additional checks such as fixings are required)				
	Deck self weight has not been allowed for, so has to be included in applied loads				

JID 158-250-750 Perfo Web (R5T8-DO)

JID

Application:	Structural metal roof deck	Finishing:	Interior liner
Yield Stress (MPa):	320	Intermediate Support width:	≥160 mm
Ym:	1	End Support width:	≥40 mm

■ = perforated zone

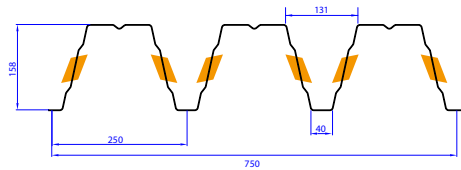

R5T8



Section properties have been derived by testing according to Eurocode 3-1.3

Mechanical Properties

tN [mm]	Weight (kg/m ²)	Broad flange in compression									Narrow flange in compression					Residual support moment		
		Mc,Rk,F [kNm/m]	Mc,Rk,B [kNm/m]	M0,Rk,B [kNm/m]	Ieff [cm ⁴ /m]	Vw,Rk [kN/m]	Rw,Rk.B [kN/m]	R0,Rk.B [kN/m]	RG,w,Rk.A [kN/m]	RT,w,Rk.A [kN/m]	Mc,Rk,F [kNm/m]	Mc,Rk,B [kNm/m]	Ieff [cm ⁴ /m]	Vw,Rk [kN/m]	Rw,Rk.A [kN/m]	Lmin [m]	Lmax [m]	MR,Rk,max [kNm/m]
0,75	11,78	14,24	10,89	14,02	437,10	15,53	26,57	28,77	8,69	8,63	11,90	15,06	421,40	15,53	15,53	6,34	7,32	3,56
0,88	13,82	20,08	15,23	17,78	517,00	25,02	37,57	49,20	12,90	13,30	15,42	18,85	510,20	25,02	25,02	7,10	8,07	4,39
1,00	15,70	25,47	19,23	21,26	590,70	36,59	47,71	68,06	16,79	17,61	18,84	22,46	582,90	36,59	36,59	7,81	8,75	5,16
1,25	19,63	35,00	25,17	27,28	744,10	70,44	63,73	92,89	27,09	28,28	24,63	29,96	734,20	70,44	70,44	8,10	9,04	6,84
1,50	23,55	42,24	30,37	32,92	897,30	119,85	76,90	112,08	32,68	34,12	29,69	37,21	885,40	119,85	119,85	8,10	9,04	8,25

Load type (kN/m²)

Thickness (mm)			Span (m)															
			5,00	5,20	5,40	5,60	5,80	6,00	6,20	6,40	6,60	6,80	7,00	7,20	7,40	7,60	7,80	
0,75	Pressure	Single	2,30	2,21	2,13	2,01	1,81	1,63	1,48	1,34	1,23	1,12						
		Double	2,30	2,21	2,13	2,05	1,98	1,92	1,86	1,79	1,70	1,62	1,55	1,48	1,42	1,36	1,30	
		Multiple	2,30	2,21	2,13	2,05	1,98	1,92	1,86	1,80	1,74	1,69	1,64	1,60	1,55	1,47	1,40	
	Suction	Single	2,54	2,35	2,16	1,94	1,74	1,57	1,43	1,30	1,18	1,08						
		Double	2,46	2,33	2,21	2,10	2,00	1,91	1,82	1,73	1,66	1,58	1,51	1,45	1,38	1,33	1,27	
		Multiple	2,88	2,74	2,60	2,48	2,36	2,26	2,15	2,06	1,97	1,89	1,81	1,72	1,59	1,46	1,35	
0,88	Pressure	Single	3,34	2,97	2,65	2,37	2,14	1,93	1,75	1,59	1,45	1,33	1,22	1,12				
		Double	3,55	3,41	3,28	3,16	2,99	2,82	2,67	2,54	2,41	2,29	2,18	2,07	1,98	1,89	1,81	
		Multiple	3,55	3,41	3,28	3,17	3,06	2,96	2,79	2,61	2,46	2,32	2,19	2,09	1,95	1,80	1,66	
	Suction	Single	3,29	2,93	2,61	2,34	2,11	1,90	1,73	1,57	1,43	1,31	1,20	1,10				
		Double	3,57	3,36	3,17	2,99	2,83	2,68	2,53	2,40	2,27	2,15	2,04	1,94	1,84	1,74	1,65	
		Multiple	4,24	4,00	3,79	3,59	3,40	3,22	3,06	2,91	2,71	2,47	2,27	2,08	1,92	1,77	1,64	
1,00	Pressure	Single	3,81	3,39	3,03	2,71	2,44	2,21	2,00	1,82	1,66	1,51	1,39	1,28	1,18			
		Double	4,70	4,50	4,23	3,97	3,75	3,54	3,34	3,16	3,00	2,85	2,70	2,57	2,45	2,34	2,23	
		Multiple	4,70	4,52	4,35	4,19	4,04	3,77	3,53	3,32	3,12	2,87	2,63	2,41	2,22	2,05	1,90	
	Suction	Single	3,76	3,34	2,99	2,68	2,41	2,18	1,97	1,79	1,63	1,49	1,37	1,26	1,16			
		Double	4,63	4,33	4,05	3,79	3,55	3,33	3,12	2,92	2,75	2,59	2,44	2,31	2,19	2,07	1,97	
		Multiple	5,59	5,24	4,93	4,64	4,36	4,11	3,73	3,39	3,09	2,83	2,59	2,38	2,19	2,03	1,87	
1,25	Pressure	Single	4,80	4,27	3,81	3,42	3,08	2,78	2,52	2,29	2,09	1,91	1,75	1,61	1,48	1,37	1,26	
		Double	6,29	5,89	5,53	5,20	4,89	4,61	4,36	4,12	3,91	3,71	3,52	3,35	3,19	3,04	2,90	
		Multiple	7,47	6,90	6,40	5,95	5,55	5,19	4,76	4,33	3,95	3,61	3,31	3,04	2,80	2,59	2,39	
	Suction	Single	4,74	4,21	3,76	3,37	3,03	2,74	2,48	2,26	2,06	1,88	1,73	1,59	1,46	1,35	1,25	
		Double	6,39	5,91	5,48	5,10	4,75	4,44	4,16	3,90	3,67	3,46	3,26	3,08	2,92	2,77	2,63	
		Multiple	7,99	7,39	6,85	6,37	5,74	5,18	4,70	4,27	3,90	3,56	3,26	3,00	2,76	2,55	2,36	
1,50	Pressure	Single	5,79	5,15	4,60	4,12	3,71	3,35	3,04	2,76	2,52	2,30	2,11	1,94	1,79	1,65	1,52	
		Double	7,59	7,11	6,67	6,27	5,90	5,57	5,26	4,98	4,71	4,47	4,25	4,04	3,84	3,66	3,50	
		Multiple	9,01	8,33	7,73	7,18	6,70	6,26	5,74	5,22	4,76	4,35	3,99	3,67	3,38	3,12	2,88	
	Suction	Single	5,71	5,08	4,53	4,07	3,66	3,31	3,00	2,72	2,48	2,27	2,08	1,91	1,76	1,63	1,50	
		Double	7,94	7,34	6,81	6,33	5,90	5,51	5,16	4,85	4,56	4,29	4,05	3,83	3,62	3,44	3,26	
		Multiple	9,90	9,15	8,48	7,69	6,92	6,25	5,67	5,15	4,70	4,29	3,94	3,62	3,33	3,08	2,85	

pressure load - deflection limit L/200
suction load - deflection limit L/150
the load shown is the ultimate load divided by 1,5

APPLIED STANDARDS / NOTES

Tolerances/Coatings	EN 10143	Steel Quality	EN 10346	Handling	European Recommendations
Tests/Calculations	EN 1990, EN 1991 1-6, EN 1993 1-3, EN 1993 1-5 (Calculations are to Eurocode, however additional checks such as fixings are required)				
	Deck self weight has not been allowed for, so has to be included in applied loads				

JID 200-375-750

JID

Application:	Structural metal roof deck	Finishing:	Interior Liner
Yield Stress (MPa):	320	Intermediate Support width:	≥160 mm
Ym:	1	End Support width:	≥40 mm

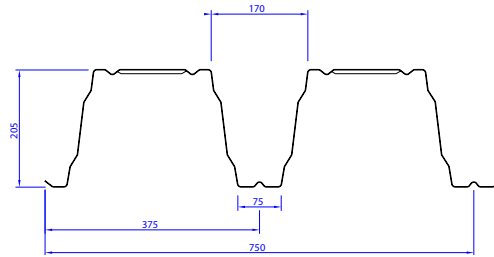

Mechanical Properties

tN [mm]	Weight (kg/m ²)	Broad flange in compression									Narrow flange in compression				
		Mc,Rk,F [kNm/m]	Mc,Rk,B [kNm/m]	M0,Rk,B [kNm/m]	I _{eff} [cm ⁴ /m]	Vw,Rk [kN/m]	Rw,Rk.B [kN/m]	R0,Rk.B [kN/m]	RG,w,Rk.A [kN/m]	RT,w,Rk.A [kN/m]	Mc,Rk,F [kNm/m]	Mc,Rk,B [kNm/m]	I _{eff} [cm ⁴ /m]	Vw,Rk [kN/m]	Rw,Rk.A [kN/m]
0,75	11,78	18,49	18,35	22,94	710,00	20,41	23,97	29,96	6,79	8,93	18,35	18,49	799,00	20,41	20,41
0,88	13,82	23,25	22,58	28,22	853,00	32,70	33,73	42,16	10,67	12,62	22,58	23,25	951,00	32,70	32,70
1,00	15,71	27,58	26,42	33,03	987,00	47,40	43,92	54,90	14,26	16,03	26,42	27,58	1087,00	47,40	47,40
1,25	19,63	36,93	34,26	42,82	1275,00	89,77	68,57	85,71	22,84	25,35	34,26	36,93	1369,00	89,77	89,77
1,50	23,56	46,74	42,00	52,50	1571,00	151,13	97,57	121,96	27,55	30,59	42,00	46,74	1651,00	151,13	151,13

Load type (kN/m²)

Thickness (mm)			Span (m)														
			6,00	6,20	6,40	6,60	6,80	7,00	7,20	7,40	7,60	7,80	8,00	8,20	8,40	8,60	8,80
0,75	Pressure	Single	1,98	1,92	1,86	1,80	1,75	1,67	1,53	1,41	1,30	1,21	1,12				
		Double	1,98	1,92	1,86	1,80	1,75	1,70	1,65	1,61	1,57	1,53	1,49	1,45	1,40	1,33	1,27
		Multiple	2,13	2,04	1,96	1,88	1,80	1,73	1,66	1,61	1,57	1,53	1,49	1,45	1,40	1,33	1,27
	Suction	Single	2,72	2,55	2,39	2,24	2,05	1,88	1,73	1,59	1,47	1,36	1,26				
		Double	2,43	2,31	2,20	2,10	2,00	1,91	1,82	1,74	1,66	1,59	1,52	1,45	1,39	1,33	1,27
		Multiple	2,88	2,75	2,62	2,51	2,40	2,29	2,19	2,10	2,01	1,93	1,85	1,78	1,70	1,64	1,57
0,88	Pressure	Single	2,80	2,71	2,62	2,39	2,19	2,01	1,84	1,70	1,57	1,45	1,34	1,25	1,16		
		Double	2,80	2,71	2,63	2,55	2,47	2,40	2,34	2,26	2,15	2,04	1,94	1,84	1,76	1,68	1,60
		Multiple	2,86	2,74	2,63	2,55	2,47	2,40	2,34	2,26	2,15	2,04	1,94	1,84	1,77	1,71	1,65
	Suction	Single	3,35	3,13	2,93	2,67	2,44	2,24	2,05	1,89	1,75	1,62	1,50	1,39	1,29		
		Double	3,36	3,17	3,00	2,83	2,68	2,53	2,39	2,26	2,15	2,04	1,94	1,84	1,76	1,68	1,60
		Multiple	4,07	3,86	3,66	3,47	3,29	3,13	2,97	2,82	2,68	2,55	2,42	2,31	2,20	2,10	2,00
1,00	Pressure	Single	3,56	3,34	3,04	2,77	2,53	2,32	2,13	1,96	1,81	1,68	1,55	1,44	1,34	1,25	1,17
		Double	3,56	3,45	3,34	3,24	3,14	3,00	2,84	2,69	2,55	2,42	2,30	2,19	2,08	1,99	1,90
		Multiple	3,57	3,45	3,34	3,24	3,14	3,00	2,84	2,69	2,55	2,44	2,35	2,26	2,18	2,10	2,03
	Suction	Single	3,91	3,67	3,34	3,05	2,79	2,56	2,35	2,16	2,00	1,85	1,71	1,59	1,48	1,38	1,29
		Double	4,09	3,83	3,59	3,38	3,18	3,00	2,84	2,69	2,55	2,42	2,30	2,19	2,08	1,99	1,90
		Multiple	5,09	4,78	4,49	4,22	3,98	3,75	3,55	3,36	3,18	3,02	2,87	2,73	2,61	2,49	2,37
1,25	Pressure	Single	4,76	4,31	3,92	3,58	3,27	3,00	2,75	2,54	2,34	2,17	2,01	1,86	1,73	1,62	1,51
		Double	5,47	5,12	4,81	4,52	4,26	4,02	3,80	3,60	3,41	3,24	3,08	2,93	2,79	2,66	2,54
		Multiple	5,47	5,12	4,81	4,52	4,26	4,02	3,90	3,74	3,58	3,44	3,30	3,18	3,06	2,94	2,84
	Suction	Single	5,08	4,63	4,21	3,84	3,51	3,22	2,96	2,72	2,51	2,33	2,16	2,00	1,86	1,74	1,62
		Double	5,47	5,12	4,81	4,52	4,26	4,02	3,80	3,60	3,41	3,24	3,08	2,93	2,79	2,66	2,54
		Multiple	6,84	6,40	6,01	5,65	5,32	5,02	4,75	4,50	4,26	4,05	3,85	3,66	3,49	3,28	3,06
1,50	Pressure	Single	5,87	5,32	4,83	4,41	4,03	3,69	3,39	3,13	2,89	2,67	2,47	2,30	2,14	1,99	1,86
		Double	6,80	6,48	6,09	5,72	5,39	5,09	4,81	4,55	4,32	4,10	3,90	3,71	3,53	3,37	3,22
		Multiple	6,80	6,48	6,13	5,85	5,58	5,33	5,09	4,87	4,67	4,47	4,29	4,12	3,96	3,77	3,52
	Suction	Single	6,16	5,59	5,08	4,63	4,23	3,88	3,57	3,29	3,03	2,81	2,60	2,41	2,25	2,09	1,95
		Double	6,92	6,48	6,09	5,72	5,39	5,09	4,81	4,55	4,32	4,10	3,90	3,71	3,53	3,37	3,22
		Multiple	8,66	8,11	7,61	7,15	6,74	6,36	6,01	5,69	5,39	5,12	4,87	4,57	4,25	3,96	3,70

pressure load - deflection limit L/200
suction load - deflection limit L/150
the load shown is the ultimate load divided by 1,5

APPLIED STANDARDS / NOTES

Tolerances/Coatings	EN 10143	Steel Quality	EN 10346	Handling	European Recommendations
Tests/Calculations	EN 1990, EN 1991 1-6, EN 1993 1-3, EN 1993 1-5 (Calculations are to Eurocode, however additional checks such as fixings are required)				
Deck self weight has not been allowed for, so has to be included in applied loads					

JID 200-375-750 Perfo Web R5T14 DO

JID

Application:	Structural metal roof deck	Finishing:	Interior Liner
Yield Stress (MPa):	320	Intermediate Support width:	≥160 mm
Ym:	1	End Support width:	≥40 mm

■ = perforated zone

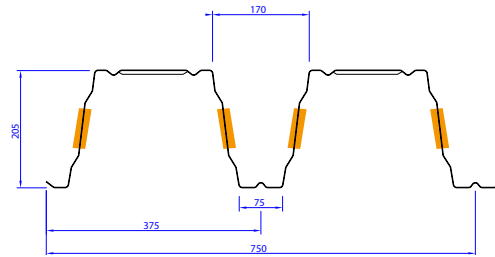

R5T14

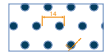

Mechanical Properties

tN [mm]	Weight (kg/m ²)	Broad flange in compression						Narrow flange in compression					
		Mc,Rk,F [kNm/m]	Mc,Rk,B [kNm/m]	Ieff [cm ⁴ /m]	Vw,Rk [kN/m]	Rw,Rk,B [kN/m]	Rw,Rk,A [kN/m]	Mc,Rk,F [kNm/m]	Mc,Rk,B [kNm/m]	Ieff [cm ⁴ /m]	Vw,Rk [kN/m]	Rw,Rk,A [kN/m]	
0,75	11,78	18,29	17,90	701,70	14,40	20,08	5,46	17,90	18,29	786,60	14,40	14,40	
0,88	13,82	23,04	21,97	842,50	23,05	28,26	7,78	21,97	23,04	934,70	23,05	23,05	
1,00	15,71	27,34	25,63	975,10	33,49	36,80	10,23	25,63	27,34	1066,60	33,49	33,49	
1,25	19,63	36,66	33,38	1259,00	63,57	57,45	16,27	33,38	36,66	1349,10	63,57	63,57	
1,50	23,56	46,41	40,95	1551,60	107,17	81,75	23,52	40,95	46,41	1627,20	107,17	107,17	

Load type (kN/m²)

Thickness (mm)			Span (m)														
			6,00	6,20	6,40	6,60	6,80	7,00	7,20	7,40	7,60	7,80	8,00	8,20	8,40	8,60	8,80
0,75	Pressure	Single	1,21	1,17	1,14	1,10											
		Double	1,38	1,32	1,26	1,20	1,15	1,11									
		Multiple	1,52	1,47	1,42	1,38	1,34	1,30	1,25	1,21	1,16	1,12					
	Suction	Single	2,65	2,48	2,33	2,19											
		Double	1,96	1,87	1,80	1,72	1,65	1,59									
		Multiple	2,14	2,06	1,98	1,90	1,83	1,76	1,70	1,64	1,58	1,53					
0,88	Pressure	Single	1,73	1,67	1,62	1,57	1,53	1,48	1,44	1,40	1,36	1,33	1,30	1,23	1,15		
		Double	1,84	1,75	1,67	1,60	1,53	1,48	1,44	1,40	1,36	1,33	1,30	1,27	1,23	1,21	1,18
		Multiple	2,16	2,07	1,98	1,89	1,81	1,74	1,67	1,60	1,54	1,48	1,43	1,37	1,32	1,28	1,23
	Suction	Single	3,25	3,05	2,86	2,69	2,53	2,39	2,26	2,14	2,03	1,93	1,83	1,74	1,66		
		Double	2,87	2,74	2,61	2,50	2,39	2,28	2,18	2,09	2,01	1,92	1,84	1,77	1,70	1,63	1,56
		Multiple	3,20	3,06	2,93	2,81	2,70	2,59	2,49	2,39	2,30	2,22	2,13	2,06	1,98	1,91	1,84
1,00	Pressure	Single	2,27	2,20	2,13	2,07	2,01	1,95	1,89	1,84	1,79	1,66	1,54	1,43	1,33	1,24	1,15
		Double	2,28	2,20	2,13	2,07	2,01	1,95	1,89	1,84	1,79	1,75	1,70	1,66	1,62	1,59	1,55
		Multiple	2,70	2,58	2,46	2,35	2,25	2,15	2,06	1,98	1,90	1,83	1,76	1,69	1,63	1,59	1,55
	Suction	Single	3,80	3,56	3,34	3,14	2,96	2,79	2,64	2,50	2,37	2,25	2,14	2,03	1,93	1,80	1,68
		Double	3,77	3,57	3,39	3,22	3,07	2,92	2,77	2,64	2,51	2,39	2,28	2,17	2,07	1,97	1,88
		Multiple	4,30	4,10	3,92	3,74	3,57	3,42	3,27	3,13	3,00	2,87	2,75	2,64	2,53	2,43	2,33
1,25	Pressure	Single	3,62	3,50	3,39	3,29	3,19	2,96	2,72	2,51	2,31	2,14	1,98	1,84	1,71	1,60	1,49
		Double	3,62	3,50	3,39	3,29	3,19	3,10	3,01	2,93	2,85	2,78	2,71	2,65	2,58	2,51	2,42
		Multiple	3,90	3,71	3,53	3,37	3,22	3,10	3,01	2,93	2,85	2,78	2,71	2,65	2,58	2,52	2,47
	Suction	Single	4,95	4,63	4,35	4,09	3,85	3,63	3,43	3,25	3,08	2,93	2,78	2,63	2,45	2,28	2,13
		Double	5,43	5,09	4,77	4,49	4,23	3,99	3,77	3,57	3,39	3,21	3,06	2,91	2,77	2,64	2,52
		Multiple	6,67	6,29	5,93	5,60	5,28	4,99	4,71	4,46	4,23	4,02	3,82	3,63	3,46	3,30	3,16
1,50	Pressure	Single	5,23	5,06	4,77	4,35	3,98	3,65	3,35	3,09	2,85	2,64	2,44	2,27	2,11	1,97	1,84
		Double	5,23	5,06	4,90	4,75	4,61	4,48	4,36	4,18	4,00	3,84	3,68	3,54	3,40	3,27	3,15
		Multiple	5,23	5,06	4,90	4,75	4,61	4,48	4,36	4,24	4,13	4,02	3,87	3,68	3,51	3,35	3,20
	Suction	Single	6,07	5,68	5,33	5,01	4,72	4,46	4,21	3,99	3,78	3,59	3,41	3,17	2,95	2,75	2,57
		Double	6,88	6,44	6,04	5,68	5,35	5,05	4,77	4,52	4,29	4,07	3,87	3,68	3,51	3,35	3,20
		Multiple	8,59	8,05	7,55	7,10	6,69	6,31	5,97	5,65	5,36	5,09	4,83	4,60	4,38	4,18	4,00

pressure load - deflection limit L/200
suction load - deflection limit L/150
the load shown is the ultimate load divided by 1,5

APPLIED STANDARDS / NOTES

Tolerances/Coatings	EN 10143	Steel Quality	EN 10346	Handling	European Recommendations
Tests/Calculations	EN 1990, EN 1991 1-6, EN 1993 1-3, EN 1993 1-5 (Calculations are to Eurocode, however additional checks such as fixings are required)				
	Deck self weight has not been allowed for, so has to be included in applied loads				



Perforated inner sheet for acoustic performance.



Structural metal roof deck.

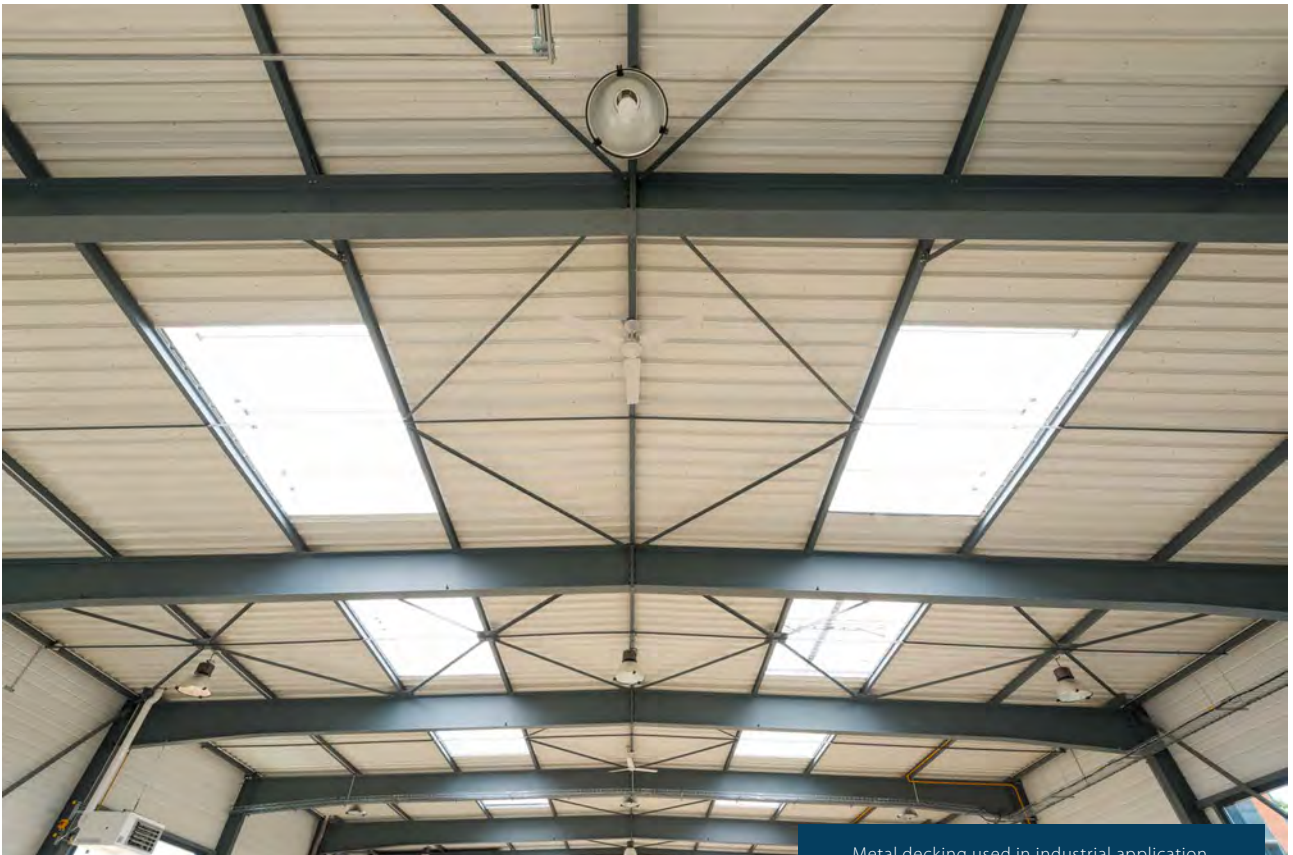

Metal decking used in industrial application.

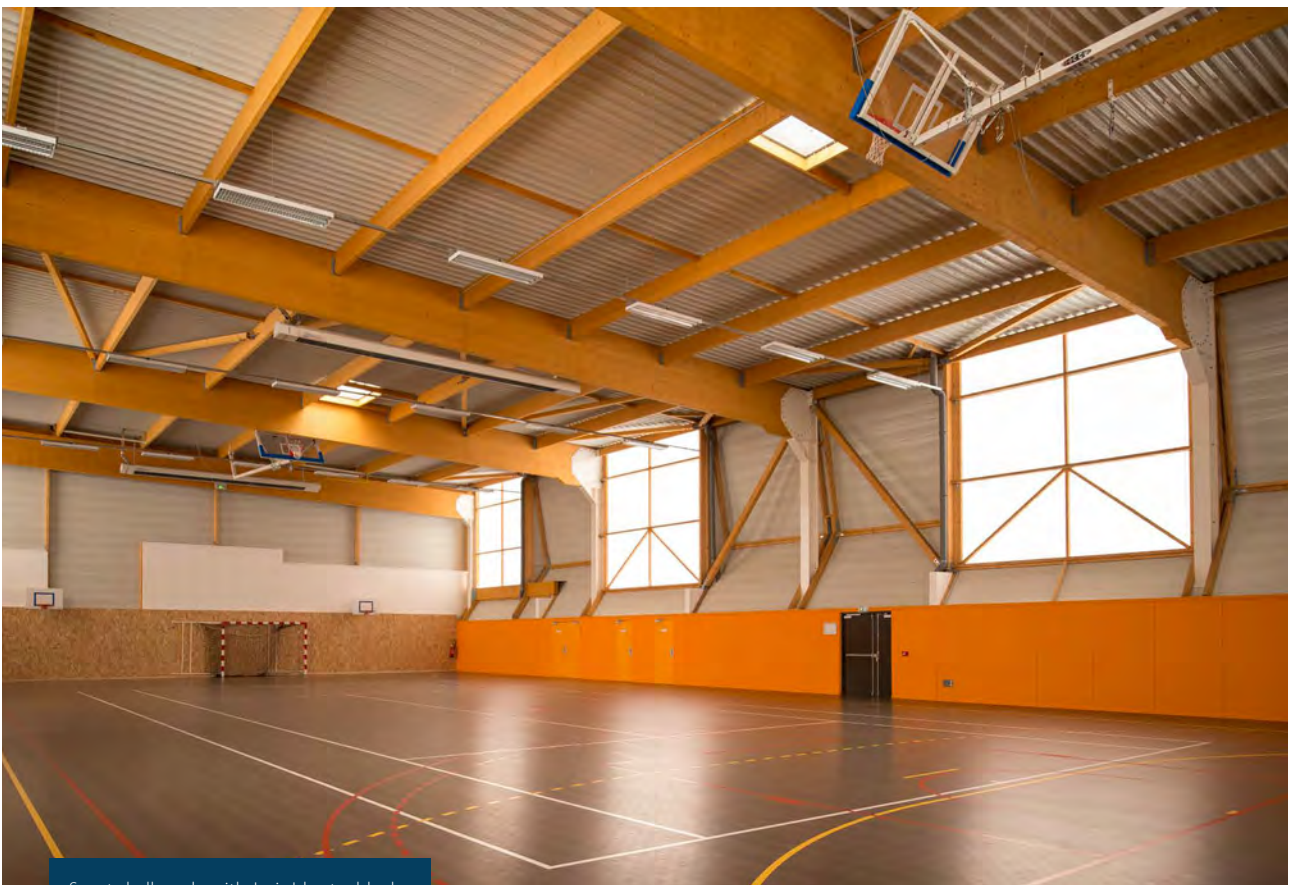

Sports hall made with Joris Ide steeldecks.

Designer's guide to structural decking

Production site:

Joris Ide Ansbach, Germany

Aluminium Decks

JID Alu 85-280-1120

JID

Application:	Structural Aluminum metal roof deck	Finishing:	Painted
Yield Stress (MPa):	180	Intermediate Support width:	≥160 mm
Ym:	1,1	End Support width:	≥40 mm

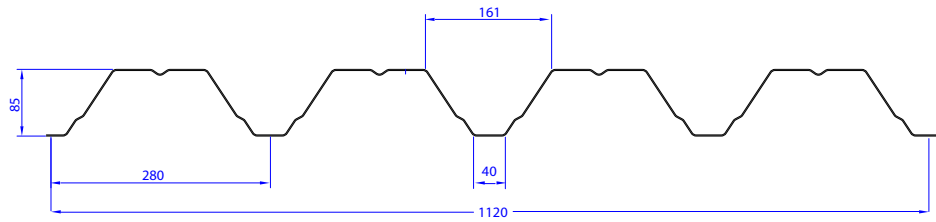

Mechanical Properties

tN [mm]	Weight (kg/m ²)	Broad flange in compression						Narrow flange in compression				
		Mc,Rk,F [kNm/m]	Mc,Rk,B [kNm/m]	I _{eff} [cm ⁴ /m]	Vw,Rk [kN/m]	Rw,Rk,B [kN/m]	Rw,Rk,A [kN/m]	Mc,Rk,F [kNm/m]	Mc,Rk,B [kNm/m]	I _{eff} [cm ⁴ /m]	Vw,Rk [kN/m]	Rw,Rk,A [kN/m]
1,00	3,80	4,03	3,70	122,61	37,94	23,16	7,06	3,70	4,03	128,41	37,94	37,94
1,25	4,75	5,39	5,09	159,67	61,28	34,96	10,82	5,09	5,39	165,63	61,28	61,28
1,50	5,70	6,83	6,32	197,31	87,05	48,72	15,29	6,32	6,83	202,69	87,05	87,05

for the use of thickness 0,75mm and 0,88mm, you should contact one of our sales agents

Load type (kN/m²)

Thickness (mm)			Span (m)														
			2,00	2,20	2,40	2,60	2,80	3,00	3,20	3,40	3,60	3,80	4,00	4,20	4,40	4,60	4,80
1,00	Pressure	Single	4,12	3,10	2,38	1,88	1,50	1,22									
		Double	4,28	3,89	3,39	2,89	2,49	2,17	1,91	1,69	1,51	1,35	1,22				
		Multiple	4,50	3,89	3,39	2,94	2,59	2,30	1,90	1,59	1,34	1,14					
	Suction	Single	4,48	3,71	3,11	2,62	2,10	1,70									
		Double	4,88	4,04	3,39	2,89	2,49	2,17	1,91	1,69	1,51	1,35	1,22				
		Multiple	6,11	5,05	4,24	3,61	3,12	2,71	2,39	2,11	1,87	1,59					
1,25	Pressure	Single	5,36	4,03	3,10	2,44	1,96	1,59	1,31								
		Double	6,53	5,40	4,54	3,87	3,33	2,90	2,55	2,26	2,02	1,81	1,62	1,40	1,21		
		Multiple	6,53	5,54	4,79	4,17	3,67	3,01	2,48	2,07	1,74	1,48	1,27	1,10			
	Suction	Single	6,17	5,10	4,28	3,38	2,70	2,20	1,81								
		Double	6,53	5,40	4,54	3,87	3,33	2,90	2,55	2,26	2,02	1,81	1,63	1,48	1,35		
		Multiple	8,17	6,75	5,67	4,83	4,17	3,63	3,19	2,83	2,41	2,05	1,75	1,52			
1,50	Pressure	Single	6,63	4,98	3,84	3,02	2,42	1,96	1,62	1,35	1,14						
		Double	8,28	6,84	5,75	4,90	4,22	3,68	3,23	2,86	2,56	2,29	2,00	1,72	1,50	1,31	1,16
		Multiple	8,43	7,18	6,18	5,36	4,57	3,72	3,06	2,55	2,15	1,83	1,57	1,35	1,18		
	Suction	Single	7,66	6,33	5,25	4,13	3,31	2,69	2,22	1,85	1,56						
		Double	8,28	6,84	5,75	4,90	4,22	3,68	3,23	2,86	2,56	2,29	2,07	1,88	1,71	1,56	1,44
		Multiple	10,35	8,55	7,19	6,12	5,28	4,60	4,04	3,50	2,94	2,50	2,15	1,85	1,61		

pressure load - deflection limit L/200

suction load - deflection limit L/150

the load shown is the ultimate load divided by 1,5

for the use of thickness 0,75mm and 0,88mm, you should contact one of our sales agents

APPLIED STANDARDS / NOTES

Aluminium Quality	EN 1396 EN 485		Handling	European Recommendations
Tests/Calculations	EN 1990, EN 1991 1-6, EN 1999 1-4 (Calculations are to Eurocode, however additional checks such as fixings are required)			
	Deck self weight has not been allowed for, so has to be included in applied loads			

JID Alu 85-280-1120 Perfo Web (R5T8-DO)

JID

Application:	Structural Aluminum metal roof deck	Finishing:	Painted
Yield Stress (MPa):	180	Intermediate Support width:	≥160 mm
Ym:	1,1	End Support width:	≥40 mm

■ = perforated zone

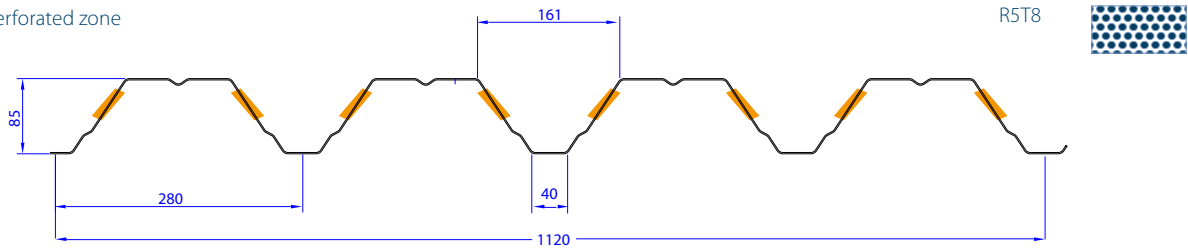

Mechanical Properties

tN [mm]	Weight [kg/m ²]	Broad flange in compression						Narrow flange in compression				
		Mc,Rk,F [kNm/m]	Mc,Rk,B [kNm/m]	I _{eff} [cm ⁴ /m]	Vw,Rk [kN/m]	Rw,Rk,B [kN/m]	Rw,Rk,A [kN/m]	Mc,Rk,F [kNm/m]	Mc,Rk,B [kNm/m]	I _{eff} [cm ⁴ /m]	Vw,Rk [kN/m]	Rw,Rk,A [kN/m]
1,00	3,80	3,20	3,51	116,28	17,76	15,87	4,76	3,51	3,20	122,79	17,76	17,76
1,25	4,75	4,53	4,84	152,24	33,61	24,03	7,32	4,84	4,53	158,66	33,61	33,61
1,50	5,70	5,91	6,04	188,76	54,73	33,54	10,36	6,04	5,91	194,36	54,73	54,73

for the use of thickness 0,75mm and 0,88mm, you should contact one of our sales agents

Load type (kN/m²)

Thickness (mm)			Span (m)															
			1,40	1,60	1,80	2,00	2,20	2,40	2,60	2,80	3,00	3,20	3,40	3,60	3,80	4,00	4,20	
1,00	Pressure	Single	4,12	3,61	3,21	2,88	2,62	2,26	1,78	1,42	1,16							
		Double	5,02	4,24	3,63	3,14	2,74	2,41	2,22	1,98	1,72	1,52	1,37	1,24	1,13			
		Multiple	5,15	4,51	4,01	3,61	3,27	2,89	2,56	2,29	2,05	1,80	1,50	1,27				
	Suction	Single	8,68	6,65	5,25	4,25	3,52	2,95	2,50	2,00	1,63							
		Double	7,52	5,98	4,79	3,88	3,21	2,69	2,30	1,98	1,72	1,52	1,34	1,20	1,07			
		Multiple	8,67	7,06	5,82	4,82	4,01	3,37	2,87	2,47	2,15	1,89	1,68	1,50				
1,25	Pressure	Single	6,34	5,55	4,93	4,44	3,84	2,96	2,33	1,86	1,52	1,25						
		Double	7,47	6,28	5,35	4,60	4,03	3,70	3,25	2,80	2,44	2,17	1,95	1,76	1,60	1,45	1,33	
		Multiple	7,92	6,93	6,16	5,49	4,79	4,21	3,72	3,31	2,87	2,36	1,97	1,66	1,41	1,21		
	Suction	Single	11,97	9,17	7,24	5,87	4,85	4,07	3,24	2,59	2,11	1,74						
		Double	11,21	8,58	6,78	5,49	4,54	3,81	3,25	2,80	2,44	2,14	1,90	1,69	1,52	1,37	1,25	
		Multiple	13,75	10,72	8,47	6,86	5,67	4,77	4,06	3,50	3,05	2,68	2,37	2,12	1,90	1,68		
1,50	Pressure	Single	8,97	7,85	6,98	6,28	4,77	3,67	2,89	2,31	1,88	1,55	1,29					
		Double	10,19	8,50	7,19	6,28	5,71	4,97	4,24	3,65	3,18	2,80	2,51	2,26	2,03	1,83	1,65	
		Multiple	11,21	9,81	8,59	7,39	6,40	5,59	4,92	4,35	3,55	2,93	2,44	2,06	1,75	1,50	1,30	
	Suction	Single	14,94	11,44	9,04	7,32	6,05	5,04	3,96	3,17	2,58	2,13	1,77					
		Double	14,62	11,19	8,84	7,16	5,92	4,97	4,24	3,65	3,18	2,80	2,48	2,21	1,98	1,79	1,62	
		Multiple	18,27	13,99	11,05	8,95	7,40	6,22	5,30	4,57	3,98	3,50	3,10	2,76	2,40	2,06	1,78	

pressure load - deflection limit L/200

suction load - deflection limit L/150

the load shown is the ultimate load divided by 1,5

for the use of thickness 0,75mm and 0,88mm, you should contact one of our sales agents

APPLIED STANDARDS / NOTES

Aluminium Quality	EN 1396 EN 485		Handling	European Recommendations
Tests/Calculations	EN 1990, EN 1991 1-6, EN 1999 1-4 (Calculations are to Eurocode, however additional checks such as fixings are required)			
	Deck self weight has not been allowed for, so has to be included in applied loads			

JID Alu 137-310-930

JID

Application:	Structural Aluminum metal roof deck	Finishing:	Painted
Yield Stress (MPa):	180	Intermediate Support width:	≥160 mm
Ym:	1,1	End Support width:	≥40 mm

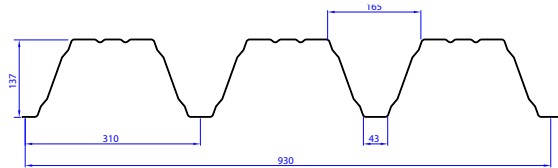

Section properties have been derived by testing according to Eurocode 3-1.3

Mechanical Properties

tN [mm]	Weight (kg/m ²)	Broad flange in compression						Narrow flange in compression				
		Mc,Rk,F [kNm/m]	Mc,Rk,B [kNm/m]	I _{eff} [cm ⁴ /m]	Vw,Rk [kN/m]	Rw,Rk,B [kN/m]	Rw,Rk,A [kN/m]	Mc,Rk,F [kNm/m]	Mc,Rk,B [kNm/m]	I _{eff} [cm ⁴ /m]	Vw,Rk [kN/m]	Rw,Rk,A [kN/m]
1,00	4,56	6,32	5,80	383,41	26,33	22,24	6,77	5,80	6,32	380,91	26,33	26,33
1,25	5,71	8,68	8,11	492,30	49,30	33,63	10,41	8,11	8,68	489,66	49,30	49,30
1,50	6,85	11,15	10,62	599,70	82,01	46,92	14,72	10,62	11,15	598,56	82,01	82,01

for the use of thickness 0,75mm and 0,88mm, you should contact one of our sales agents

Load type (kN/m²)

Thickness (mm)			Span (m)														
			2,40	2,60	2,80	3,00	3,20	3,40	3,60	3,80	4,00	4,20	4,40	4,60	4,80	5,00	5,20
1,00	Pressure	Single	3,42	3,16	2,93	2,74	2,56	2,41	2,21	1,88	1,61	1,39	1,21				
		Double	3,60	3,20	2,93	2,74	2,56	2,41	2,28	2,12	1,92	1,74	1,58	1,45	1,33	1,23	1,13
		Multiple	4,27	3,82	3,44	3,10	2,81	2,56	2,34	2,14	1,97	1,81	1,68	1,55	1,44	1,34	1,25
	Suction	Single	4,88	4,16	3,59	3,12	2,75	2,43	2,17	1,95	1,76	1,59	1,45				
		Double	5,32	4,50	3,91	3,40	2,99	2,65	2,36	2,12	1,92	1,74	1,58	1,45	1,33	1,23	1,13
		Multiple	6,46	5,61	4,88	4,25	3,74	3,31	2,96	2,65	2,39	2,17	1,98	1,81	1,66	1,53	1,42
1,25	Pressure	Single	5,26	4,85	4,51	4,21	3,94	3,37	2,84	2,41	2,07	1,79	1,55	1,36	1,20		
		Double	5,28	4,85	4,51	4,21	3,94	3,64	3,25	2,91	2,63	2,39	2,17	1,99	1,83	1,68	1,56
		Multiple	6,31	5,62	5,04	4,53	4,10	3,72	3,39	3,10	2,84	2,61	2,41	2,23	2,06	1,92	1,78
	Suction	Single	6,83	5,82	5,02	4,37	3,84	3,40	3,03	2,72	2,46	2,23	2,03	1,80	1,59		
		Double	7,31	6,23	5,37	4,68	4,11	3,64	3,25	2,91	2,63	2,39	2,17	1,99	1,83	1,68	1,56
		Multiple	9,13	7,78	6,71	5,85	5,14	4,55	4,06	3,64	3,29	2,98	2,72	2,49	2,28	2,10	1,95
1,50	Pressure	Single	7,43	6,86	6,37	5,95	4,92	4,10	3,46	2,94	2,52	2,18	1,89	1,66	1,46	1,29	1,15
		Double	7,43	6,86	6,37	5,95	5,28	4,68	4,17	3,74	3,38	3,06	2,79	2,55	2,35	2,16	2,00
		Multiple	8,61	7,65	6,84	6,14	5,54	5,01	4,56	4,16	3,80	3,49	3,22	2,97	2,75	2,44	2,17
	Suction	Single	8,94	7,62	6,57	5,72	5,03	4,45	3,97	3,57	3,22	2,90	2,52	2,20	1,94	1,72	1,53
		Double	9,39	8,00	6,90	6,01	5,28	4,68	4,17	3,74	3,38	3,06	2,79	2,55	2,35	2,16	2,00
		Multiple	11,73	10,00	8,62	7,51	6,60	5,85	5,21	4,68	4,22	3,83	3,49	3,19	2,93	2,70	2,50

pressure load - deflection limit L/200

suction load - deflection limit L/150

the load shown is the ultimate load divided by 1,5

for the use of thickness 0,75mm and 0,88mm, you should contact one of our sales agents

APPLIED STANDARDS / NOTES

Aluminium Quality	EN 1396 EN 485		Handling	European Recommendations
Tests/Calculations	EN 1990, EN 1991 1-6, EN 1999 1-4 (Calculations are to Eurocode, however additional checks such as fixings are required)			
	Deck self weight has not been allowed for, so has to be included in applied loads			

JID Alu 137-310-930 Perfo Web (R5T8-DO)

JID

Application:	Structural Aluminum metal roof deck	Finishing:	Painted
Yield Stress (MPa):	180	Intermediate Support width:	≥160 mm
Ym:	1,1	End Support width:	≥40 mm

■ = perforated zone

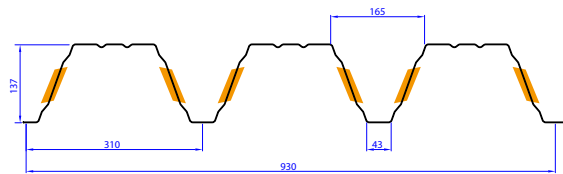

R5T8



Section properties have been derived by testing according to Eurocode 3-1.3

Mechanical Properties

tN [mm]	Weight (kg/m ²)	Broad flange in compression						Narrow flange in compression				
		Mc,Rk,F [kNm/m]	Mc,Rk,B [kNm/m]	I _{eff} [cm ⁴ /m]	Vw,Rk [kN/m]	Rw,Rk,B [kN/m]	Rw,Rk,A [kN/m]	Mc,Rk,F [kNm/m]	Mc,Rk,B [kNm/m]	I _{eff} [cm ⁴ /m]	Vw,Rk [kN/m]	Rw,Rk,A [kN/m]
1,00	4,56	6,08	5,27	371,67	12,70	16,33	4,92	5,27	6,08	359,22	12,70	12,70
1,25	5,71	8,42	7,40	476,92	23,82	24,75	7,56	7,40	8,42	464,18	23,82	23,82
1,50	6,85	10,86	9,72	580,70	39,93	34,56	10,70	9,72	10,86	568,92	39,93	39,93

for the use of thickness 0,75mm and 0,88mm, you should contact one of our sales agents

Load type (kN/m²)

Thickness (mm)			Span (m)														
			2,00	2,20	2,40	2,60	2,80	3,00	3,20	3,40	3,60	3,80	4,00	4,20	4,40	4,60	4,80
1,00	Pressure	Single	2,98	2,71	2,48	2,29	2,13	1,99	1,86	1,75	1,66	1,57	1,49	1,35	1,17		
		Double	3,56	3,16	2,82	2,54	2,29	2,08	1,89	1,75	1,66	1,57	1,49	1,42	1,36	1,30	1,24
		Multiple	3,73	3,39	3,11	2,87	2,66	2,47	2,25	2,07	1,90	1,75	1,62	1,50	1,39	1,30	1,24
	Suction	Single	6,39	5,28	4,44	3,78	3,26	2,84	2,50	2,21	1,97	1,77	1,60	1,45	1,32		
		Double	4,87	4,31	3,85	3,45	3,11	2,82	2,56	2,34	2,13	1,95	1,79	1,65	1,51	1,39	1,28
		Multiple	5,30	4,71	4,23	3,82	3,47	3,16	2,89	2,66	2,45	2,26	2,09	1,94	1,80	1,67	1,56
1,25	Pressure	Single	4,58	4,17	3,82	3,52	3,27	3,05	2,86	2,70	2,55	2,34	2,00	1,73	1,50	1,32	1,16
		Double	5,32	4,70	4,19	3,75	3,38	3,05	2,86	2,70	2,55	2,41	2,29	2,18	2,08	1,93	1,77
		Multiple	5,73	5,21	4,77	4,41	4,01	3,64	3,32	3,04	2,78	2,56	2,36	2,19	2,08	1,93	1,77
	Suction	Single	8,97	7,41	6,23	5,31	4,58	3,99	3,50	3,10	2,77	2,48	2,24	2,03	1,85	1,70	1,50
		Double	8,28	7,23	6,36	5,62	4,98	4,43	3,95	3,53	3,15	2,81	2,55	2,31	2,11	1,93	1,77
		Multiple	9,19	8,10	7,19	6,42	5,76	5,18	4,68	4,24	3,85	3,50	3,18	2,89	2,63	2,39	2,21
1,50	Pressure	Single	6,48	5,90	5,40	4,99	4,63	4,32	4,05	3,81	3,35	2,84	2,44	2,11	1,83	1,60	1,41
		Double	7,32	6,46	5,74	5,13	4,63	4,32	4,05	3,81	3,60	3,41	3,24	2,98	2,72	2,49	2,29
		Multiple	8,11	7,37	6,76	6,09	5,49	4,97	4,52	4,13	3,78	3,47	3,24	2,98	2,73	2,53	2,35
	Suction	Single	11,78	9,74	8,18	6,97	6,01	5,24	4,60	4,08	3,64	3,26	2,95	2,67	2,39	2,09	1,84
		Double	12,24	10,48	9,02	7,77	6,71	5,85	5,14	4,55	4,06	3,65	3,29	2,98	2,72	2,49	2,29
		Multiple	13,99	12,15	10,63	9,33	8,23	7,27	6,43	5,68	5,08	4,56	4,11	3,73	3,40	3,11	2,86

pressure load - deflection limit L/200

suction load - deflection limit L/150

the load shown is the ultimate load divided by 1,5

for the use of thickness 0,75mm and 0,88mm, you should contact one of our sales agents

APPLIED STANDARDS / NOTES

Aluminium Quality	EN 1396 EN 485		Handling	European Recommendations
Tests/Calculations	EN 1990, EN 1991 1-6, EN 1999 1-4 (Calculations are to Eurocode, however additional checks such as fixings are required)			
	Deck self weight has not been allowed for, so has to be included in applied loads			

JID Alu 153-280-840

JID

Application:	Structural Aluminum metal roof deck	Finishing:	Painted
Yield Stress (MPa):	180	Intermediate Support width:	≥160 mm
Ym:	1,1	End Support width:	≥40 mm

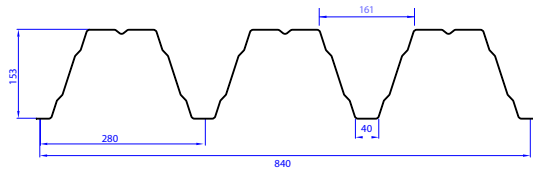

Section properties have been derived by testing according to Eurocode 3-1.3

Mechanical Properties

tN [mm]	Weight (kg/m ²)	Broad flange in compression						Narrow flange in compression				
		Mc,Rk,F [kNm/m]	Mc,Rk,B [kNm/m]	Ieff [cm ⁴ /m]	Vw,Rk [kN/m]	Rw,Rk,B [kN/m]	Rw,Rk,A [kN/m]	Mc,Rk,F [kNm/m]	Mc,Rk,B [kNm/m]	Ieff [cm ⁴ /m]	Vw,Rk [kN/m]	Rw,Rk,A [kN/m]
1,00	5,05	8,56	7,24	475,97	26,38	25,22	7,68	7,24	8,56	498,75	26,38	26,38
1,25	6,32	11,83	10,21	624,74	49,98	38,05	11,78	10,21	11,83	649,03	49,98	49,98
1,50	7,58	15,05	13,33	770,43	84,22	53,01	16,63	13,33	15,05	789,96	84,22	84,22

for the use of thickness 0,75mm and 0,88mm, you should contact one of our sales agents

Load type (kN/m²)

Thickness (mm)			Span (m)														
			3,00	3,20	3,40	3,60	3,80	4,00	4,20	4,40	4,60	4,80	5,00	5,20	5,40	5,60	5,80
1,00	Pressure	Single	3,10	2,91	2,74	2,59	2,33	2,00	1,73	1,50	1,31	1,16					
		Double	3,10	2,91	2,74	2,59	2,45	2,33	2,22	2,12	1,96	1,80	1,66	1,53	1,42	1,32	1,23
		Multiple	3,66	3,33	3,04	2,78	2,56	2,36	2,22	2,12	1,96	1,80	1,66	1,53	1,42	1,33	1,24
	Suction	Single	3,90	3,43	3,04	2,71	2,43	2,19	1,99	1,81	1,66	1,52					
		Double	4,59	4,05	3,58	3,20	2,87	2,59	2,35	2,14	1,96	1,80	1,66	1,53	1,42	1,32	1,23
		Multiple	5,46	4,91	4,42	3,98	3,59	3,24	2,92	2,68	2,45	2,25	2,08	1,92	1,78	1,65	1,54
1,25	Pressure	Single	4,76	4,46	4,20	3,60	3,06	2,62	2,27	1,97	1,73	1,52	1,34	1,19			
		Double	4,76	4,46	4,20	3,97	3,76	3,57	3,25	2,96	2,71	2,49	2,29	2,12	1,97	1,83	1,71
		Multiple	5,37	4,88	4,44	4,06	3,76	3,57	3,25	2,96	2,71	2,51	2,34	2,18	2,02	1,81	1,63
	Suction	Single	5,50	4,83	4,28	3,82	3,43	3,09	2,81	2,56	2,34	2,10	1,86	1,65			
		Double	6,37	5,60	4,96	4,43	3,97	3,58	3,25	2,96	2,71	2,49	2,29	2,12	1,97	1,83	1,71
		Multiple	7,97	7,00	6,20	5,53	4,97	4,48	4,06	3,70	3,39	3,11	2,87	2,65	2,46	2,29	2,13
1,50	Pressure	Single	6,72	6,30	5,27	4,44	3,77	3,24	2,80	2,43	2,13	1,87	1,66	1,47	1,32	1,18	
		Double	6,72	6,30	5,93	5,60	5,05	4,56	4,14	3,77	3,45	3,17	2,92	2,70	2,50	2,33	2,17
		Multiple	7,28	6,59	5,99	5,60	5,05	4,59	4,23	3,90	3,61	3,35	3,11	2,79	2,49	2,23	2,01
	Suction	Single	7,18	6,31	5,59	4,99	4,48	4,04	3,66	3,32	2,91	2,56	2,26	2,01	1,80	1,61	
		Double	8,11	7,13	6,31	5,63	5,05	4,56	4,14	3,77	3,45	3,17	2,92	2,70	2,50	2,33	2,17
		Multiple	10,13	8,91	7,89	7,04	6,32	5,70	5,17	4,71	4,31	3,96	3,65	3,37	3,13	2,91	2,71

pressure load - deflection limit L/200

suction load - deflection limit L/150

the load shown is the ultimate load divided by 1,5

for the use of thickness 0,75mm and 0,88mm, you should contact one of our sales agents

APPLIED STANDARDS / NOTES

Aluminium Quality	EN 1396 EN 485		Handling	European Recommendations
Tests/Calculations	EN 1990, EN 1991 1-6, EN 1999 1-4 (Calculations are to Eurocode, however additional checks such as fixings are required)			
	Deck self weight has not been allowed for, so has to be included in applied loads			

JID Alu 153-280-840 Perfo Web (R5T8-DO)

JID

Application:	Structural Aluminum metal roof deck	Finishing:	Painted
Yield Stress (MPa):	180	Intermediate Support width:	≥160 mm
Ym:	1,1	End Support width:	≥40 mm

■ = perforated zone

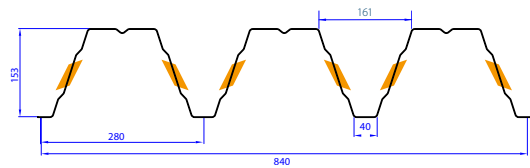

R5T8

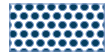

Section properties have been derived by testing according to Eurocode 3-1.3

Mechanical Properties

tN [mm]	Weight (kg/m ²)	Broad flange in compression						Narrow flange in compression				
		Mc,Rk,F [kNm/m]	Mc,Rk,B [kNm/m]	I _{eff} [cm ⁴ /m]	Vw,Rk [kN/m]	Rw,Rk,B [kN/m]	Rw,Rk,A [kN/m]	Mc,Rk,F [kNm/m]	Mc,Rk,B [kNm/m]	I _{eff} [cm ⁴ /m]	Vw,Rk [kN/m]	Rw,Rk,A [kN/m]
1,00	5,05	8,44	6,70	468,36	12,86	19,06	5,74	6,70	8,44	481,30	12,86	12,86
1,25	6,32	11,74	9,53	614,11	24,36	28,81	8,82	9,53	11,74	629,37	24,36	24,36
1,50	7,58	14,89	12,51	756,66	41,07	40,17	12,46	12,51	14,89	767,09	41,07	41,07

for the use of thickness 0,75mm and 0,88mm, you should contact one of our sales agents

Load type (kN/m²)

Thickness (mm)			Span (m)														
			2,60	2,80	3,00	3,20	3,40	3,60	3,80	4,00	4,20	4,40	4,60	4,80	5,00	5,20	5,40
1,00	Pressure	Single	2,68	2,48	2,32	2,17	2,05	1,93	1,83	1,74	1,66	1,48	1,29	1,14			
		Double	3,04	2,75	2,50	2,28	2,09	1,93	1,83	1,74	1,66	1,58	1,51	1,45	1,39	1,34	1,29
		Multiple	3,34	3,11	2,90	2,71	2,49	2,30	2,12	1,97	1,83	1,70	1,59	1,48	1,39	1,34	1,29
	Suction	Single	4,81	4,14	3,61	3,17	2,81	2,51	2,25	2,03	1,84	1,68	1,54	1,41			
		Double	3,85	3,50	3,21	2,95	2,72	2,51	2,33	2,17	2,02	1,88	1,76	1,65	1,54	1,45	1,36
		Multiple	4,17	3,81	3,51	3,23	3,00	2,78	2,59	2,42	2,27	2,13	2,00	1,88	1,77	1,67	1,58
1,25	Pressure	Single	4,11	3,82	3,56	3,34	3,14	2,97	2,81	2,58	2,23	1,94	1,70	1,49	1,32	1,17	
		Double	4,51	4,08	3,70	3,37	3,14	2,97	2,81	2,67	2,55	2,43	2,32	2,23	2,14	2,06	1,95
		Multiple	5,14	4,77	4,39	4,01	3,68	3,39	3,13	2,89	2,68	2,49	2,32	2,23	2,14	2,06	1,95
	Suction	Single	6,84	5,89	5,13	4,51	4,00	3,57	3,20	2,89	2,62	2,39	2,18	2,01	1,80	1,60	
		Double	6,63	5,99	5,42	4,93	4,50	4,11	3,77	3,45	3,17	2,92	2,68	2,47	2,27	2,09	1,95
		Multiple	7,34	6,66	6,07	5,56	5,11	4,71	4,35	4,02	3,73	3,46	3,22	3,00	2,79	2,60	2,43
1,50	Pressure	Single	5,81	5,39	5,03	4,72	4,44	4,20	3,71	3,18	2,75	2,39	2,09	1,84	1,63	1,45	1,29
		Double	6,17	5,56	5,04	4,72	4,44	4,20	3,97	3,78	3,60	3,43	3,28	3,13	2,89	2,67	2,48
		Multiple	7,26	6,60	6,00	5,47	5,01	4,60	4,24	3,92	3,63	3,43	3,28	3,13	2,89	2,67	2,44
	Suction	Single	8,97	7,74	6,74	5,92	5,25	4,68	4,20	3,79	3,44	3,13	2,82	2,49	2,20	1,96	1,75
		Double	9,83	8,73	7,78	6,95	6,22	5,57	4,99	4,51	4,09	3,73	3,41	3,13	2,89	2,67	2,48
		Multiple	11,19	10,05	9,06	8,20	7,43	6,76	6,15	5,60	5,11	4,66	4,25	3,92	3,61	3,34	3,09

pressure load - deflection limit L/200

suction load - deflection limit L/150

the load shown is the ultimate load divided by 1,5

for the use of thickness 0,75mm and 0,88mm, you should contact one of our sales agents

APPLIED STANDARDS / NOTES

Aluminium Quality	EN 1396 EN 485		Handling	European Recommendations
Tests/Calculations	EN 1990, EN 1991 1-6, EN 1999 1-4 (Calculations are to Eurocode, however additional checks such as fixings are required)			
	Deck self weight has not been allowed for, so has to be included in applied loads			

JID Alu 158-250-750

JID

Application:	Structural Aluminum metal roof deck	Finishing:	Painted
Yield Stress (MPa):	180	Intermediate Support width:	≥160 mm
Ym:	1,1	End Support width:	≥40 mm

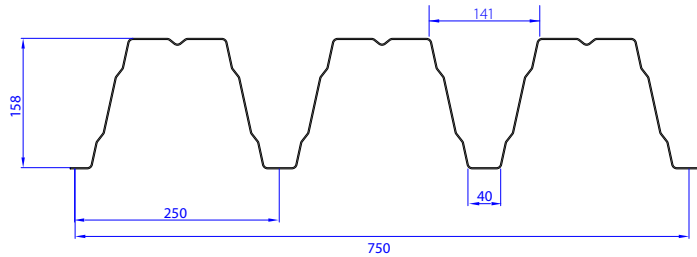

Mechanical Properties

tN [mm]	Weight (kg/m ²)	Broad flange in compression						Narrow flange in compression				
		Mc,Rk,F [kNm/m]	Mc,Rk,B [kNm/m]	I _{eff} [cm ⁴ /m]	Vw,Rk [kN/m]	Rw,Rk,B [kN/m]	Rw,Rk,A [kN/m]	Mc,Rk,F [kNm/m]	Mc,Rk,B [kNm/m]	I _{eff} [cm ⁴ /m]	Vw,Rk [kN/m]	Rw,Rk,A [kN/m]
1,00	5,66	9,90	8,36	566,48	29,66	29,15	8,88	8,36	9,90	593,77	29,66	29,66
1,25	7,08	13,68	11,78	743,30	56,21	44,00	13,62	11,78	13,68	772,39	56,21	56,21
1,50	8,49	17,36	15,38	916,29	94,70	61,30	19,23	15,38	17,36	939,60	94,70	94,70

for the use of thickness 0,75mm and 0,88mm, you should contact one of our sales agents

Load type (kN/m²)

Thickness (mm)			Span (m)														
			3,40	3,60	3,80	4,00	4,20	4,40	4,60	4,80	5,00	5,20	5,40	5,60	5,80	6,00	6,20
1,00	Pressure	Single	3,17	2,99	2,77	2,38	2,06	1,79	1,56	1,38	1,22						
		Double	3,17	2,99	2,83	2,69	2,56	2,45	2,27	2,08	1,92	1,78	1,65	1,53	1,43	1,33	1,25
		Multiple	3,51	3,22	2,95	2,72	2,56	2,45	2,27	2,08	1,92	1,78	1,65	1,54	1,44	1,33	1,21
	Suction	Single	3,51	3,13	2,81	2,53	2,30	2,09	1,92	1,76	1,62						
		Double	4,15	3,68	3,32	3,00	2,72	2,48	2,27	2,08	1,92	1,78	1,65	1,53	1,43	1,33	1,25
		Multiple	5,07	4,58	4,14	3,75	3,39	3,07	2,84	2,60	2,40	2,22	2,06	1,91	1,78	1,67	1,56
1,25	Pressure	Single	4,86	4,28	3,64	3,12	2,70	2,35	2,05	1,81	1,60	1,42	1,27	1,14			
		Double	4,86	4,59	4,34	4,13	3,76	3,43	3,13	2,88	2,65	2,45	2,27	2,12	1,97	1,84	1,73
		Multiple	5,13	4,69	4,34	4,13	3,76	3,43	3,13	2,90	2,70	2,52	2,36	2,15	1,94	1,75	1,59
	Suction	Single	4,94	4,41	3,96	3,57	3,24	2,95	2,70	2,48	2,21	1,97	1,76	1,58			
		Double	5,74	5,12	4,59	4,15	3,76	3,43	3,13	2,88	2,65	2,45	2,27	2,12	1,97	1,84	1,73
		Multiple	7,17	6,40	5,74	5,18	4,70	4,28	3,92	3,60	3,32	3,07	2,84	2,64	2,46	2,30	2,16
1,50	Pressure	Single	6,27	5,28	4,49	3,85	3,32	2,89	2,53	2,23	1,97	1,75	1,56	1,40	1,26	1,14	
		Double	6,86	6,47	5,83	5,26	4,77	4,35	3,98	3,65	3,37	3,11	2,89	2,68	2,50	2,34	2,19
		Multiple	6,92	6,47	5,83	5,30	4,88	4,50	4,17	3,87	3,60	3,31	2,96	2,65	2,39	2,16	1,95
	Suction	Single	6,45	5,75	5,16	4,66	4,23	3,85	3,46	3,05	2,69	2,39	2,14	1,92	1,73	1,56	
		Double	7,28	6,49	5,83	5,26	4,77	4,35	3,98	3,65	3,37	3,11	2,89	2,68	2,50	2,34	2,19
		Multiple	9,10	8,12	7,29	6,58	5,96	5,43	4,97	4,57	4,21	3,89	3,61	3,35	3,13	2,92	2,67

pressure load - deflection limit L/200

suction load - deflection limit L/150

the load shown is the ultimate load divided by 1,5

for the use of thickness 0,75mm and 0,88mm, you should contact one of our sales agents

APPLIED STANDARDS / NOTES

Aluminium Quality	EN 1396 EN 485		Handling	European Recommendations
Tests/Calculations	EN 1990, EN 1991 1-6, EN 1999 1-4 (Calculations are to Eurocode, however additional checks such as fixings are required)			
	Deck self weight has not been allowed for, so has to be included in applied loads			

JID Alu 158-250-750 Perfo Web (R5T8-DO)

JID

Application:	Structural Aluminum metal roof deck	Finishing:	Painted
Yield Stress (MPa):	180	Intermediate Support width:	≥160 mm
Ym:	1,1	End Support width:	≥40 mm

■ = perforated zone

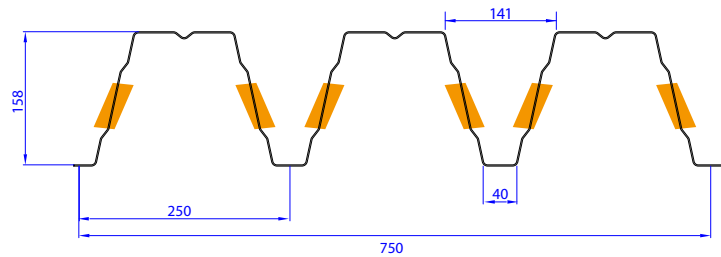

R5T8

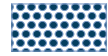

Mechanical Properties

tN [mm]	Weight (kg/m ²)	Broad flange in compression						Narrow flange in compression				
		Mc,Rk,F [kNm/m]	Mc,Rk,B [kNm/m]	I _{eff} [cm ⁴ /m]	Vw,Rk [kN/m]	Rw,Rk,B [kN/m]	Rw,Rk,A [kN/m]	Mc,Rk,F [kNm/m]	Mc,Rk,B [kNm/m]	I _{eff} [cm ⁴ /m]	Vw,Rk [kN/m]	Rw,Rk,A [kN/m]
1,00	5,66	9,52	7,60	549,13	14,31	21,40	6,45	7,60	9,52	559,96	14,31	14,31
1,25	7,08	13,27	10,75	720,08	27,16	32,38	9,89	10,75	13,27	732,20	27,16	27,16
1,50	8,49	16,91	14,08	887,26	46,11	45,15	13,98	14,08	16,91	893,07	46,11	46,11

for the use of thickness 0,75mm and 0,88mm, you should contact one of our sales agents

Load type (kN/m²)

Thickness (mm)			Span (m)														
			3,00	3,20	3,40	3,60	3,80	4,00	4,20	4,40	4,60	4,80	5,00	5,20	5,40	5,60	5,80
1,00	Pressure	Single	2,61	2,44	2,30	2,17	2,06	1,95	1,86	1,73	1,52	1,33	1,18				
		Double	2,82	2,57	2,36	2,17	2,06	1,95	1,86	1,78	1,70	1,63	1,56	1,50	1,45	1,40	1,35
		Multiple	3,26	3,05	2,80	2,59	2,39	2,22	2,06	1,92	1,79	1,67	1,57	1,50	1,45	1,40	1,35
	Suction	Single	4,09	3,60	3,19	2,84	2,55	2,30	2,09	1,90	1,74	1,60	1,47				
		Double	3,58	3,29	3,04	2,81	2,61	2,43	2,26	2,11	1,97	1,85	1,73	1,63	1,53	1,44	1,35
		Multiple	3,91	3,61	3,35	3,11	2,90	2,71	2,54	2,38	2,24	2,11	1,99	1,87	1,77	1,68	1,59
1,25	Pressure	Single	4,00	3,75	3,53	3,33	3,15	3,00	2,61	2,27	1,99	1,75	1,55	1,38	1,23	1,10	
		Double	4,16	3,79	3,53	3,33	3,15	3,00	2,85	2,72	2,61	2,50	2,40	2,31	2,21	2,05	1,91
		Multiple	4,94	4,51	4,14	3,81	3,52	3,26	3,02	2,81	2,61	2,50	2,40	2,31	2,21	2,05	1,88
	Suction	Single	5,79	5,09	4,51	4,02	3,61	3,26	2,95	2,69	2,46	2,26	2,08	1,87	1,67	1,49	
		Double	6,08	5,54	5,05	4,62	4,24	3,89	3,58	3,29	3,03	2,79	2,57	2,37	2,21	2,05	1,91
		Multiple	6,81	6,23	5,73	5,28	4,88	4,52	4,19	3,90	3,62	3,38	3,15	2,94	2,74	2,56	2,39
1,50	Pressure	Single	5,65	5,30	4,98	4,71	4,35	3,73	3,22	2,80	2,45	2,16	1,91	1,70	1,51	1,36	1,22
		Double	5,67	5,30	4,98	4,71	4,46	4,24	4,03	3,85	3,68	3,53	3,28	3,03	2,81	2,61	2,44
		Multiple	6,74	6,15	5,64	5,18	4,77	4,40	4,08	3,85	3,68	3,53	3,28	3,03	2,81	2,57	2,31
	Suction	Single	7,59	6,67	5,91	5,27	4,73	4,27	3,87	3,53	3,23	2,89	2,56	2,28	2,03	1,82	1,64
		Double	8,81	7,88	7,05	6,32	5,67	5,08	4,65	4,23	3,87	3,56	3,28	3,03	2,81	2,61	2,44
		Multiple	10,23	9,26	8,41	7,65	6,97	6,35	5,80	5,29	4,83	4,41	4,10	3,79	3,51	3,27	3,05

pressure load - deflection limit L/200

suction load - deflection limit L/150

the load shown is the ultimate load divided by 1,5

for the use of thickness 0,75mm and 0,88mm, you should contact one of our sales agents

APPLIED STANDARDS / NOTES

Aluminium Quality	EN 1396 EN 485		Handling	European Recommendations
Tests/Calculations	EN 1990, EN 1991 1-6, EN 1999 1-4 (Calculations are to Eurocode, however additional checks such as fixings are required)			
	Deck self weight has not been allowed for, so has to be included in applied loads			

JID Alu 200-375-750

JID

Application:	Structural Aluminum metal roof deck	Finishing:	Painted
Yield Stress (MPa):	180	Intermediate Support width:	≥160 mm
Ym:	1,1	End Support width:	≥40 mm

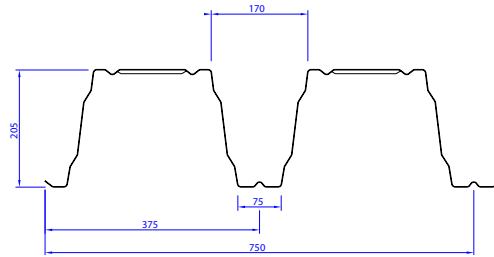

Mechanical Properties

tN [mm]	Weight (kg/m ²)	Broad flange in compression						Narrow flange in compression				
		Mc,Rk,F [kNm/m]	Mc,Rk,B [kNm/m]	I _{eff} [cm ⁴ /m]	Vw,Rk [kN/m]	Rw,Rk.B [kN/m]	Rw,Rk.A [kN/m]	Mc,Rk,F [kNm/m]	Mc,Rk,B [kNm/m]	I _{eff} [cm ⁴ /m]	Vw,Rk [kN/m]	Rw,Rk.A [kN/m]
1,00	5,66	11,12	10,27	969,15	17,25	18,04	5,50	10,27	11,12	1111,25	17,25	17,25
1,25	7,08	15,40	14,70	1245,18	32,42	27,74	8,59	14,70	15,40	1413,66	32,42	32,42
1,50	8,49	19,84	19,36	1518,37	54,32	39,09	12,26	19,36	19,84	1700,85	54,32	54,32

for the use of thickness 0,75mm and 0,88mm, you should contact one of our sales agents

Load type (kN/m²)

Thickness (mm)			Span (m)														
			3,40	3,60	3,80	4,00	4,20	4,40	4,60	4,80	5,00	5,20	5,40	5,60	5,80	6,00	6,20
1,00	Pressure	Single	1,96	1,85	1,75	1,67	1,59	1,52	1,45	1,39	1,33	1,28	1,23	1,19	1,15	1,11	
		Double	2,29	2,13	1,99	1,86	1,75	1,64	1,55	1,46	1,38	1,30	1,23	1,19	1,15	1,11	
		Multiple	2,45	2,31	2,19	2,08	1,98	1,89	1,81	1,72	1,63	1,54	1,46	1,39	1,32	1,26	1,20
	Suction	Single	4,31	3,84	3,45	3,11	2,82	2,57	2,35	2,16	1,99	1,84	1,71	1,59	1,48	1,38	
		Double	3,62	3,35	3,10	2,88	2,69	2,50	2,34	2,19	2,05	1,92	1,80	1,69	1,59	1,49	
		Multiple	4,00	3,71	3,46	3,23	3,02	2,83	2,66	2,50	2,36	2,22	2,10	1,99	1,88	1,78	1,68
1,25	Pressure	Single	3,06	2,89	2,74	2,60	2,48	2,37	2,26	2,17	2,08	2,00	1,93	1,86	1,72	1,55	1,40
		Double	3,47	3,22	3,00	2,81	2,63	2,47	2,32	2,18	2,08	2,00	1,93	1,86	1,80	1,74	1,68
		Multiple	3,83	3,62	3,43	3,25	3,09	2,91	2,74	2,58	2,44	2,31	2,19	2,08	1,97	1,88	1,79
	Suction	Single	6,17	5,50	4,94	4,45	4,04	3,68	3,37	3,09	2,85	2,64	2,44	2,27	2,12	1,98	1,85
		Double	5,94	5,42	4,96	4,55	4,18	3,84	3,53	3,24	2,98	2,74	2,56	2,38	2,22	2,07	1,94
		Multiple	6,76	6,22	5,75	5,31	4,92	4,57	4,25	3,95	3,68	3,43	3,19	2,98	2,77	2,59	2,41
1,50	Pressure	Single	4,37	4,13	3,91	3,72	3,54	3,38	3,23	3,10	2,97	2,86	2,59	2,32	2,09	1,89	1,71
		Double	4,80	4,46	4,15	3,87	3,62	3,39	3,23	3,10	2,97	2,86	2,75	2,65	2,56	2,48	2,40
		Multiple	5,46	5,16	4,88	4,56	4,27	4,01	3,77	3,56	3,35	3,17	3,00	2,84	2,70	2,56	2,43
	Suction	Single	8,12	7,24	6,50	5,87	5,32	4,85	4,44	4,07	3,75	3,47	3,22	2,99	2,79	2,61	2,44
		Double	8,28	7,42	6,65	5,96	5,45	4,97	4,55	4,18	3,85	3,56	3,30	3,07	2,86	2,67	2,50
		Multiple	9,88	8,98	8,18	7,46	6,80	6,21	5,67	5,17	4,81	4,45	4,12	3,83	3,57	3,34	3,13

pressure load - deflection limit L/200

suction load - deflection limit L/150

the load shown is the ultimate load divided by 1,5

for the use of thickness 0,75mm and 0,88mm, you should contact one of our sales agents

APPLIED STANDARDS / NOTES

Aluminium Quality	EN 1396 EN 485		Handling	European Recommendations
Tests/Calculations	EN 1990, EN 1991 1-6, EN 1999 1-4 (Calculations are to Eurocode, however additional checks such as fixings are required)			
	Deck self weight has not been allowed for, so has to be included in applied loads			

JID Alu 200-375-750 Perfo Web (R5T14-DO)

JID

Application:	Structural Aluminum metal roof deck	Finishing:	Painted
Yield Stress (MPa):	180	Intermediate Support width:	≥160 mm
Ym:	1,1	End Support width:	≥40 mm

■ = perforated zone

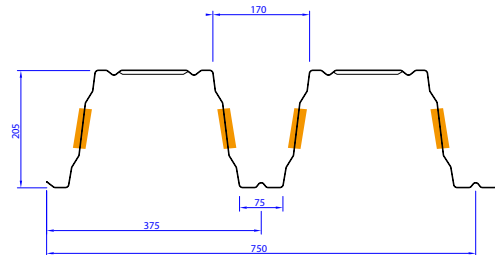

R5T14

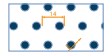

Mechanical Properties

tN [mm]	Weight (kg/m ²)	Broad flange in compression						Narrow flange in compression				
		Mc,Rk,F [kNm/m]	Mc,Rk,B [kNm/m]	I _{eff} [cm ⁴ /m]	Vw,Rk [kN/m]	Rw,Rk,B [kN/m]	Rw,Rk,A [kN/m]	Mc,Rk,F [kNm/m]	Mc,Rk,B [kNm/m]	I _{eff} [cm ⁴ /m]	Vw,Rk [kN/m]	Rw,Rk,A [kN/m]
1,00	5,66	10,92	10,07	957,76	12,99	15,68	4,75	10,07	10,92	1093,64	12,99	12,99
1,25	7,08	15,22	14,42	1232,45	24,42	24,11	7,42	14,42	15,22	1394,36	24,42	24,42
1,50	8,49	19,88	19,08	1505,56	40,91	34,01	10,61	19,08	19,88	1676,10	40,91	40,91

for the use of thickness 0,75mm and 0,88mm, you should contact one of our sales agents

Load type (kN/m²)

Thickness (mm)			Span (m)															
			5,00	5,20	5,40	5,60	5,80	6,00	6,20	6,40	6,60	6,80	7,00	7,20	7,40	7,60	7,80	
1,00	Pressure	Single	1,15	1,11	1,07	1,03												
		Double	1,25	1,18	1,12	1,07	1,02											
		Multiple	1,44	1,38	1,33	1,26	1,20	1,15	1,10	1,05	1,00							
	Suction	Single	1,95	1,81	1,67	1,56	1,45	1,36	1,27	1,19	1,12	1,06	1,00					
		Double	1,77	1,67	1,58	1,50	1,42	1,35	1,28	1,22	1,16	1,10	1,05	1,00				
		Multiple	1,97	1,87	1,78	1,69	1,61	1,54	1,47	1,40	1,34	1,28	1,22	1,17	1,12	1,08	1,03	
1,25	Pressure	Single	1,80	1,73	1,67	1,61	1,55	1,50	1,39	1,26	1,15	1,05						
		Double	1,87	1,77	1,68	1,61	1,55	1,50	1,45	1,41	1,36	1,32	1,28	1,25	1,22	1,18	1,15	
		Multiple	2,21	2,10	1,99	1,89	1,80	1,72	1,64	1,56	1,49	1,43	1,37	1,31	1,26	1,21	1,16	
	Suction	Single	2,80	2,59	2,40	2,23	2,08	1,94	1,82	1,71	1,61	1,51	1,43	1,34	1,23	1,14	1,05	
		Double	2,84	2,65	2,49	2,33	2,18	2,05	1,92	1,80	1,69	1,58	1,51	1,42	1,35	1,28	1,21	
		Multiple	3,28	3,09	2,92	2,76	2,60	2,46	2,33	2,21	2,09	1,98	1,87	1,78	1,68	1,60	1,51	
1,50	Pressure	Single	2,57	2,47	2,38	2,30	2,07	1,87	1,70	1,54	1,41	1,29	1,18	1,08	1,00			
		Double	2,58	2,47	2,38	2,30	2,22	2,14	2,07	2,01	1,95	1,89	1,84	1,79	1,74	1,67	1,58	
		Multiple	3,05	2,89	2,74	2,61	2,48	2,36	2,25	2,14	2,05	1,95	1,87	1,79	1,74	1,67	1,58	
	Suction	Single	3,70	3,42	3,17	2,95	2,75	2,57	2,41	2,26	2,09	1,91	1,75	1,61	1,48	1,37	1,27	
		Double	3,86	3,55	3,31	3,07	2,87	2,68	2,51	2,35	2,21	2,08	1,97	1,86	1,76	1,67	1,58	
		Multiple	4,72	4,40	4,11	3,84	3,58	3,34	3,12	2,91	2,77	2,61	2,46	2,32	2,20	2,09	1,98	

pressure load - deflection limit L/200

suction load - deflection limit L/150

the load shown is the ultimate load divided by 1,5

for the use of thickness 0,75mm and 0,88mm, you should contact one of our sales agents

APPLIED STANDARDS / NOTES

Aluminium Quality	EN 1396 EN 485		Handling	European Recommendations
Tests/Calculations	EN 1990, EN 1991 1-6, EN 1999 1-4 (Calculations are to Eurocode, however additional checks such as fixings are required)			
	Deck self weight has not been allowed for, so has to be included in applied loads			



Storage building made with JI decks.



Automotive dealership - JI 106-250-750.

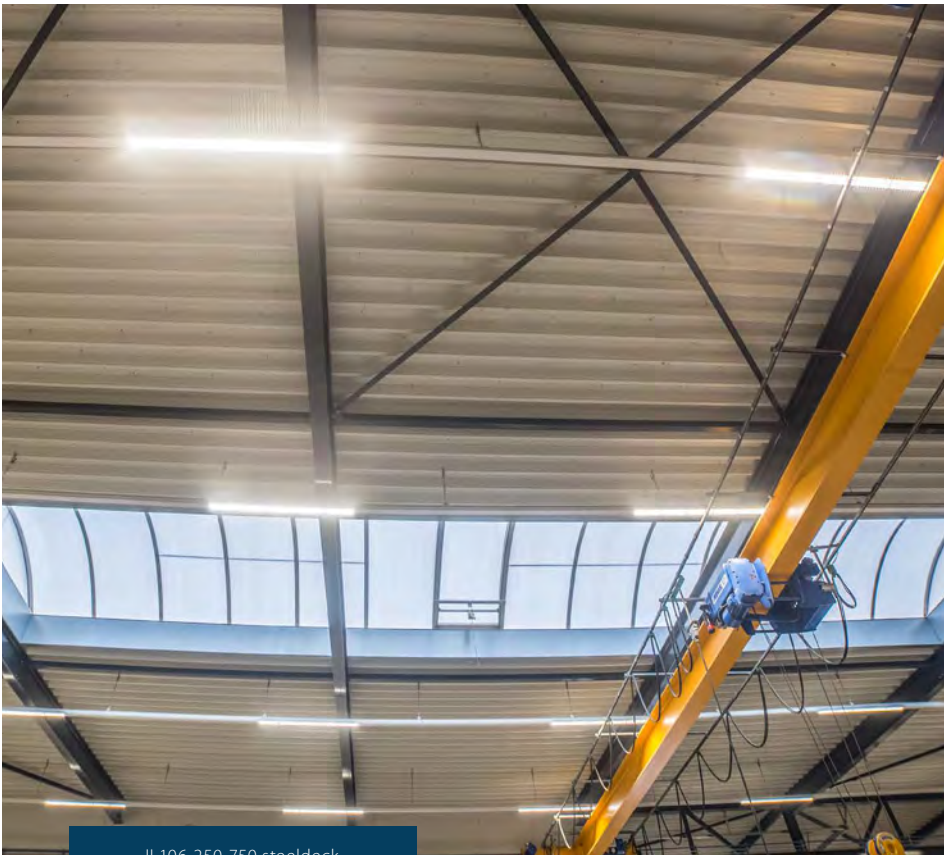

J1 106-250-750 steeldeck.

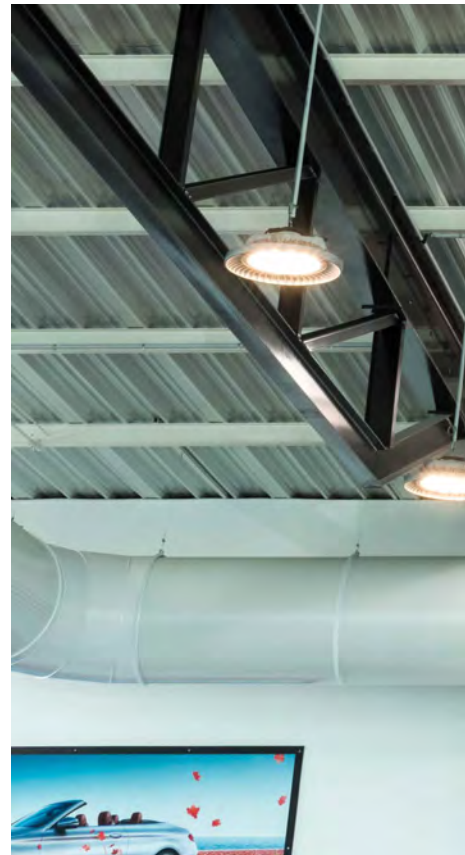

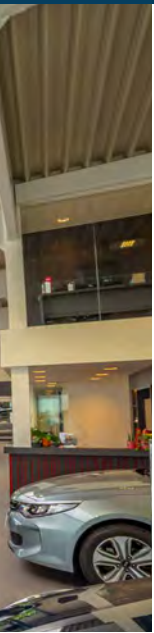

Structural perforated deck.



Joris Ide steeldeck



Acoustic application for this automotive dealership building.



JORISIDE

THE STEEL FUTURE

Joris Ide Ltd.

A9, Elmbridge Court,
Gloucester GL3 1JZ, United Kingdom

☎ +44 (0)1452 412 069

☎ +44 (0)1452 358 025

✉ sales@joriside.co.uk

Joris Ide nv/sa

Hille 174,
8750 Zwevezele, Belgium

☎ +32 (0)51 61 07 77

☎ +32 (0)51 61 07 79

✉ info@joriside.be



With more than 30 years of experience, Joris Ide represents a guarantee of quality in the construction market. We provide solutions in all fields: acoustic, aesthetic, fire, thermal. Joris Ide, the essential partner for all your projects.



JORIS IDE IS
**PLANET
PASSIONATE**

